TABLE OF CONTENTS

Specifications	2-2
Quick Spec Guide	2-4
Elevations: 1/4" Scale	2-6
Casement	2-9
Casement Picture	2-17
Casement Sector Top	2-21
French Casement	2-28
French Sector Top Casement	2-34
French Half Round Casement	2-36
Extended Half Round	2-37
Extended Quarter Round	2-40
Glazing Options	2-42
Trim Options	2-49
Jamb Options	2-50
Mullion Details & Specialty Trim	2-51
Grille & SDL Patterns	2-54
Clear Opening and Daylight Specifications	2-55
Unit Sizing, Rough Openings & Masonry Openings	2-67
Section Details: 6" Scale	2-68
Bays & Bows Opening Specifications	2-90
Section Details : Bays & Bows - 3" Scale	2-98

PRODUCT SPECIFICATIONS**EXTERIOR FINISH**

The standard exterior is factory-applied latex primer with an option for unfinished (stain grade) natural pine exterior available.

AURALAST® WOOD

AuraLast® wood is fundamentally different from wood treated in traditional millwork preservation processes in that it uses a proprietary vacuum/pressure process to provide protection throughout the wood parts used to make windows and doors. AuraLast® wood is distinguished from wood using traditional preservation methods by its unique ability to achieve greater penetration of the active ingredients into the wood parts, with a minimum treatment penetration of 92%.

INTERIOR FINISH

Interior surfaces are unfinished clear pine ready for on-site finishing. Optional prefinished pine interiors include four acrylic colors (Moderate White, Extra White, Natural Choice, Pure White), four stains (Wheat, Cherry, Fruitwood, Cordovan) and a clear lacquer topcoat. Primed interior is also available.

FRAME

Frame is assembled from select kiln-dried pine AuraLast® wood on all exterior parts. Standard jamb width is 4-9/16".

SASH

2-3/32" thick select kiln-dried pine AuraLast® wood. Corner joints are mortised-and-tenoned, with the glass mounted into the sash using a silicone-glazing compound on the exterior and acrylic sealant on the interior, then secured with interior applied profiled wood stops. To accommodate the new nesting crank hardware, the height of the bottom rail has been increased to 2-3/32".

GLAZING

Insulating glass is constructed from two panes of glass, utilizing a continuous roll formed stainless steel spacer with dual seal sealant. The glass is mounted into the sash using a silicone-glazing compound and secured with interior applied profiled wood stops. All insulating glass units comply with the performance requirements of IGCC in accordance with either ASTM E774 or E2190.

GLAZING OPTIONS

Insulating glass available in Low-E with Argon, Low-E, Low-E 366, Clear, Neat Glass, Seedy Reamy, tinted, reflective, or obscure, tempered or other specialty glass as specified. Preserve® film is a 0.003" thick polyethylene film with a low tack acrylic adhesive applied to the glass for protection during shipping and installation. Installations at 4,000 foot elevations and higher require a capillary tube to equalize environmental stress (otherwise known as High Altitude glazing). High Altitude glazing does not allow the use of Argon as listed under glazing options.

WEATHER-STRIPPING

Engineered system combines foam lined bulb seal compressed between the interior of the sash and the frame in a continuous plane on all four sides with a secondary bulb seal compressed between the edge of the sash and the frame.

HARDWARE

Operating sash are mounted to the frame with corrosion resistant steel hinges. The operating hardware consists of hardened steel worm gears and dual action heavy gauge steel operating arms. The sash is secured with concealed type locking hardware. The interior operator cover, nesting crank handle, and locking handle standard finish options are White, Chestnut Bronze, and Desert Sand, with optional finishes in plated Polished Brass, Antique Brass, Polished Chrome, Brushed Chrome and Oil Rubbed Bronze.

INTERIOR INSECT SCREENS

Charcoal fiberglass screen cloth (18x16 mesh) set in painted roll formed aluminum frame fitted to the inside of the window with all necessary hardware, in White, Chestnut Bronze or Desert Sand finishes. Wood veneer wrapped screen frames and Phantom screens are available in Ponderosa Pine. Insect screens are intended to allow air and light in and to keep insects out. They are not intended to keep anyone or anything from falling through an open window. For safety screens or other security devices contact your local building supply retailer.

GRILLES

SDL (Simulated Divided Lites) - extruded pre-primed aluminum muntins permanently applied to the exterior of the insulating glass unit (not available on textured glass) in 7/8", 1-1/8", or 1-3/8" widths. Profiles are bead stop in all widths, and a putty profile in the 7/8" and 1-1/8" widths only. 1" Copper SDL is also available. SDL is standard with a light bronze internal shadow bar to give a true divided lite appearance. As an option, SDL may be ordered with a silver shadow bar or without a shadow bar. Clear wood interior muntin bars match the exterior muntin width and are permanently bonded to the interior of the glass. Also available is a 2-5/16" SDL bar, which simulates a double-hung checkrail.

PDL (Precise Divided Lites) - Wood or extruded aluminum muntins permanently applied to the exterior of the insulating unit (not available on textured glass) in 3/4" and 1-1/2" widths without a shadow bar. Clear wood interior muntin bars match the exterior muntin width and are permanently bonded to the interior of the glass.

Full Surround Removable Wood Grilles - Rectangular, unfinished interior clear pine wood grilles in 7/8", 1-1/8", and 1-3/8" are available in patterns selected by the owner.

GBG (Grilles between the Glass) - 5/8" (15.9mm) flat and 23/32" or 1" contour mounted between the glass panes suspended within the air cavity.

EXTERIOR TRIM

Brickmould standard with optional 3-1/2", 4-1/2", 5-1/2" flat trim, 3-1/2" Adams and 1 x 4 Backband trim. Optional mull covers to accommodate 1" (spread only), 2", 3-1/2" and 6" spread and stud pocket mull.

EXTENSION JAMBS

Extensions are applied to the interior on all four sides of the frame in wall depths up to 9-1/8" for 4/4 and up to 13-11/16" for 5/4, factory applied.

Continued on next page

PRODUCT SPECIFICATIONS

INSTALLATION

Installation per JELD-WEN Installation Method for Wood Windows.
See www.jeld-wen.com/resources for instructions.

PERFORMANCE

NFRC Certified - (rated and labeled in accordance with NFRC 100 and 200 procedures)

ANSI/AAMA/NWDA/101/I.S.2-97
AMMA/WDMA/CSA 101/I.S.2/A440-05
WDMA Hallmark Certified

See www.jeld-wen.com for architectural and performance information.

QUICK SPEC GUIDE

SPECIFICATION	STANDARD FEATURES	OPTIONAL FEATURES <i>Some options may require additional lead times. Consult your JELD-WEN Sales Representative.</i>
EXTERIOR FINISH	<ul style="list-style-type: none"> Primed 	<ul style="list-style-type: none"> Natural <p>Sash Only:</p> <ul style="list-style-type: none"> Bright Copper* <i>*Copper is only available when ordered with a clad sash</i> Speckled Patina Copper Hand Rubbed Patina Copper (sash only)
EXTERIOR TRIM	<ul style="list-style-type: none"> Brickmould & Subsill 	<ul style="list-style-type: none"> Adams Casing 3-1/2" Flat Casing 4-1/2" Flat Casing Extended Sill Nose 1x4 Backband Extended Sill Nose
INTERIOR WOOD	<ul style="list-style-type: none"> Western Pine 	
INTERIOR FINISH	<ul style="list-style-type: none"> Natural 	<ul style="list-style-type: none"> Priming Available <p>Pre-finished Interior Options are:</p> <ul style="list-style-type: none"> Paint - Pure White, Extra White, Natural Choice, Moderate White Stain - Wheat, Fruitwood, Cherry, Cordovan Clear Lacquer
SIZE	<ul style="list-style-type: none"> Width: 18, 20, 24, 28, 30, 32, 36 Height: 18, 20, 24, 30, 32, 36, 40, 42, 48, 54, 56, 60, 64, 66, 72, 78, 84 	<ul style="list-style-type: none"> Any Width: 14 to 36 Any Height: 16 to 84
GLAZING	<ul style="list-style-type: none"> Low-E Insulating Glass (with Argon) Preserve® Protective Film 	<ul style="list-style-type: none"> Clear Low-E 366 Obscure Tints: Bronze, Gray, Solex Reflective: Bronze and Gray Glue Chip Safety Lamine in Clear, Bronze or Gray Neat Glass Seedy Reamy Rain Narrow Reed Tempered Impact Resistant
GRILLES		<p>SDL Bead Profile:</p> <ul style="list-style-type: none"> 7/8", 1-1/8", 1-3/8", 2-5/16" with Light Bronze Shadow Bar <p>SDL Putty Profile:</p> <ul style="list-style-type: none"> 7/8" and 1-1/8" with Light Bronze Shadow Bar 7/8" and 1-1/8" with Silver Shadow Bar 7/8" and 1-1/8" with No Shadow Bar <ul style="list-style-type: none"> 1" Copper SDL <p>PDL:</p> <ul style="list-style-type: none"> 3/4" or 1-1/2" Precise Divided Lite <p>GBG (Grilles between the Glass):</p> <ul style="list-style-type: none"> 5/8" Flat, 23/32" Contour, 1" Contour GBG <p>Full Surround:</p> <ul style="list-style-type: none"> 7/8", 1-1/8", 1-3/8" Full Surround Wood Grilles 7/8", 1-1/8", 1-3/8", 2-5/16" with Silver Shadow Bar 7/8", 1-1/8", 1-3/8", 2-5/16" with No Shadow Bar

Continued on next page

QUICK SPEC GUIDE

SPECIFICATION	STANDARD FEATURES	OPTIONAL FEATURES <i>Some options may require additional lead times. Consult your JELD-WEN Sales Representative.</i>
HARDWARE	<ul style="list-style-type: none"> • Nesting Handle • Concealed Locking System 	<ul style="list-style-type: none"> • Round Knob
HARDWARE COLOR	<ul style="list-style-type: none"> • White • Chestnut Bronze • Desert Sand 	<ul style="list-style-type: none"> • Polished Brass • Antique Brass • Polished Chrome <ul style="list-style-type: none"> • Brushed Chrome • Oil Rubbed Bronze
JAMB	<ul style="list-style-type: none"> • Applied, 5/4 • 4-9/16" 	<ul style="list-style-type: none"> • Up to 9-1/8" 4/4 • Up to 13-11/16" 5/4
INSECT SCREENS	<ul style="list-style-type: none"> • Fiberglass 	<ul style="list-style-type: none"> • Phantom Screen and wood veneer wrapped screens available in Pine
SCREEN FRAME COLOR	<ul style="list-style-type: none"> • White • Chestnut Bronze • Desert Sand 	<p>Wood Veneer (Interior)</p> <ul style="list-style-type: none"> • Pondersoa Pine • Vertical Grain Douglas Fir <ul style="list-style-type: none"> • Mahogany • Pacific Coast Red Alder

GENERAL INFORMATION
CASEMENT

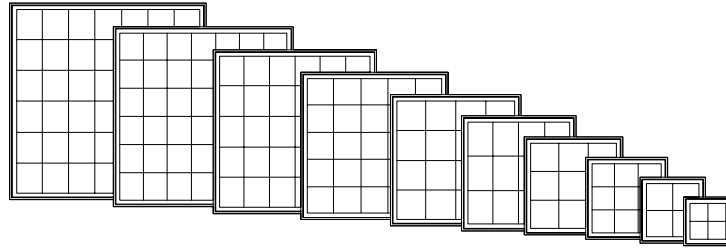

DIMENSIONAL WINDOWS

Wood casement windows may be specified as "dimensional", by adjusting the desired rough opening width or height in 1/4" increments from standard.

Wood casement windows are available with left or right hand operation, or stationary (non-venting). Operating mechanism includes corrosion resistant steel hinges and dual arm roto-type operator with hardened steel gears and operating arms. Sash locks are concealed unison type with an exposed locking lever and escutcheon plate. There are several interior hardware finish options. Refer to the Specifications for finish options.

MULTIPLE ASSEMBLIES

Wood casement windows may be mullied above, below, or beside other wood casement windows, or other wood window products. Factory assembled mulls are limited in height (100"), width (150"), and a total area (75 square feet).

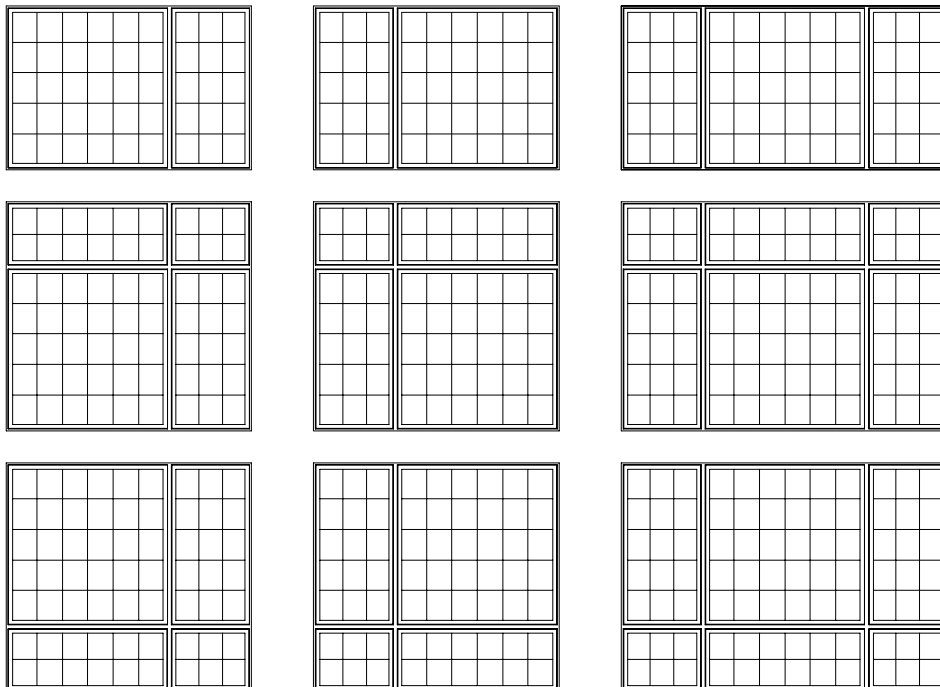

**HANDING & OPERATION
CASEMENT**

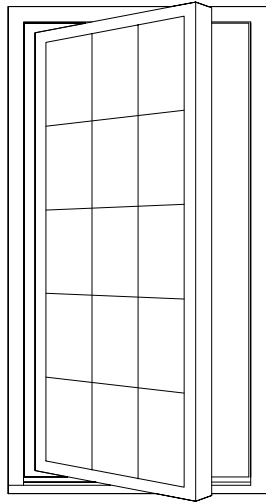

**LEFT
HAND**

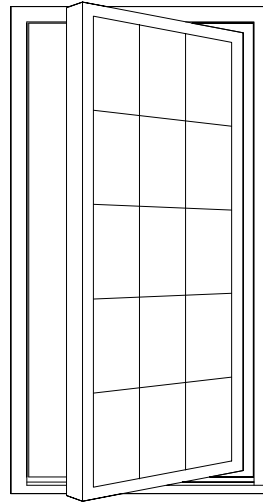

**RIGHT
HAND**

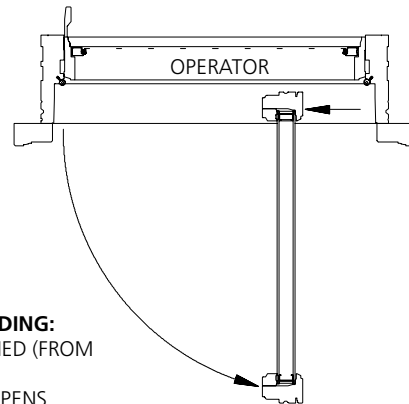
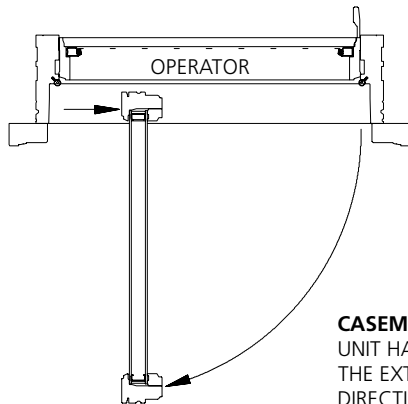

CASEMENT UNIT HANDING:
UNIT HANDING IS DEFINED (FROM
THE EXTERIOR) AS THE
DIRECTION THE SASH OPENS.

ELEVATION NOTES
CASEMENT

ELEVATION DRAWINGS UTILIZE A LIMITED NUMBER OF PROJECTED LINES TO PRODUCE A RUDIMENTARY DRAWING INTENDED TO BE USED IN A SMALL GRAPHICAL SCALE. ELEVATIONS ARE VIEWED PERPENDICULAR FROM THE EXTERIOR OF THE STRUCTURE. IF MORE DIMENSIONS ARE NEEDED, USE THE SECTION DRAWINGS FOR MORE COMPLETE DEPICTIONS.

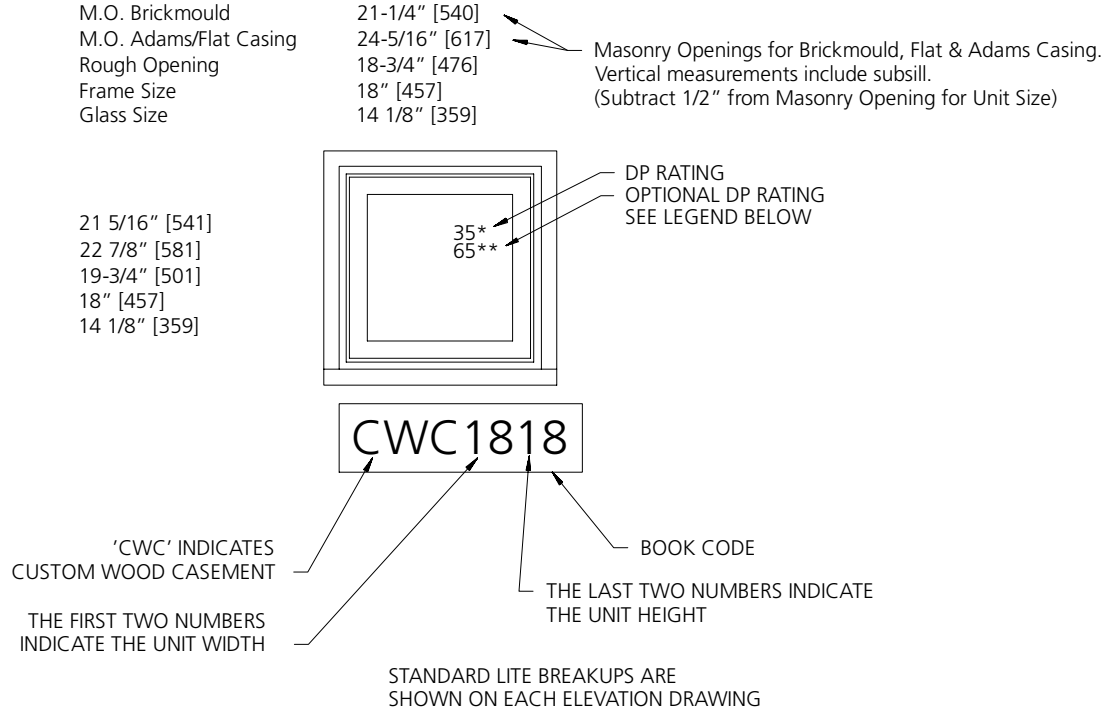

GENERAL CASEMENT NOTES

1. WOOD CASEMENT (WC) UNITS ARE AVAILABLE AS OPERATING OR STATIONARY UNITS.
2. 'WCP' IN A BOOK CODE DENOTES THE UNIT IS A WOOD CASEMENT PICTURE (STATIONARY) UNITS.
3. UNIT ELEVATIONS ARE SHOWN WITH BRICKMOULD AND SUBSILL.
4. ELEVATION DRAWINGS SHOW STANDARD LIGHT CUTS FOR 7/8" [22] OR 1 1/8" [29] GRILLE BARS OR SIMULATED DIVIDED LITE.
5. OPERATING UNITS ARE AVAILABLE AS LEFT OR RIGHT HAND OPERATION.
6. DIMENSIONAL VALUES IN BRACKETS ARE MILLIMETER CONVERSIONS.
7. ALL GLASS SIZES ARE NOMINAL.

ELEVATION SYMBOL LEGEND:

- | | |
|-------------|---|
| E | BASIC UNIT CLEAR OPENING EXCEEDS 20" IN WIDTH, 24" IN HEIGHT & A MINIMUM OF 5.7 SQ. FT. |
| E* | BASIC UNIT CLEAR OPENING REQUIRES EGRESS HINGES TO EXCEED 20" IN WIDTH, 24" IN HEIGHT & A MINIMUM, OF 5.7 SQ. FT. |
| S | STATIONARY UNIT |
| LO | LIMITED OPERATION |
| ##* | NUMBER INDICATES DESIGN PRESSURE (DP) RATING WITH STANDARD GLAZING. |
| ##** | NUMBER INDICATES OPTIONAL DESIGN PRESSURE (DP) RATING. |
| ##^ | NUMBER INDICATES OPTIONAL DESIGN PRESSURE (DP) RATING ON STATIONARY UNITS. |
| ##^^ | NUMBER INDICATES OPTIONAL DESIGN PRESSURE (DP) RATING ON OPERATING UNITS. |

1-WIDE UNITS

M.O. BRICKMOULD	21 1/4"(540)	23 1/4"(591)	27 1/4"(692)	31 1/4"(794)	33 1/4"(845)	35 1/4"(895)	39 1/4"(997)
M.O. ADAMS/FLAT CASING	24 5/16"(618)	26 5/16"(668)	30 5/16"(770)	34 5/16"(872)	36 5/16"(922)	38 5/16"(973)	42 5/16"(1075)
ROUGH OPENING	18 3/4"(476)	20 3/4"(527)	24 3/4"(629)	28 3/4"(730)	30 3/4"(781)	32 3/4"(832)	36 3/4"(933)
FRAME SIZE	18"(457)	20"(508)	24"(610)	28"(711)	30"(762)	32"(813)	36"(914)
DAYLIGHT OPENING	13 1/16"(332)	15 1/16"(383)	19 1/16"(484)	23 1/16"(586)	25 1/16"(637)	27 1/16"(687)	31 1/16"(789)

21 11/32"(542) 22 7/8"(581) 19 3/4"(501) 18"(457) 12 13/32"(317)							
23 11/32"(593) 24 7/8"(632) 21 3/4"(552) 20"(508) 14 15/32"(368)							
27 11/32"(695) 28 7/8"(733) 25 3/4"(654) 24"(610) 18 15/32"(469)							
33 11/32"(847) 34 7/8"(886) 31 3/4"(806) 30"(762) 24 15/32"(622)							
35 11/32"(898) 36 7/8"(937) 33 3/4"(857) 32"(813) 26 15/32"(672)							
39 11/32"(999) 40 7/8"(1038) 37 3/4"(958) 36"(914) 30 15/32"(774)							
43 11/32"(1101) 44 7/8"(1140) 41 3/4"(1060) 40"(1016) 34 15/32"(876)							
45 11/32"(1152) 46 7/8"(1191) 43 3/4"(1111) 42"(1067) 36 15/32"(926)							

ELEVATION SYMBOL LEGEND:

M.O. = MASONRY OPENING

VALUES IN () ARE IN MILLIMETER CONVERSIONS

E BASIC UNIT CLEAR OPENING EXCEEDS 20" IN WIDTH, 24" IN HEIGHT & A MINIMUM OF 5.7 SQ. FT.

E* BASIC UNIT CLEAR OPENING REQUIRES EGRESS HINGES TO EXCEED 20" IN WIDTH, 24" IN HEIGHT & A MINIMUM, OF 5.7 SQ. FT.

NUMBER INDICATES DESIGN PRESSURE (DP) RATING WITH STANDARD GLAZING.

NUMBER INDICATES OPTIONAL DESIGN PRESSURE (DP) RATING.

Note: Elevations shown DO NOT have exterior trim. Subtract 1/2" (12.7) from M.O. (Masonry Opening) for Unit Sizes. Masonry Openings above include Sill Nose, see Trim Options page for Sill Nose specifications. For other Trim Options refer to the Unit Sizing, Rough Opening & Masonry Openings page.

SCALE: 1/4" = 1'

1-WIDE UNITS

M.O. BRICKMOUND
M.O. ADAMS/FLAT CASING
ROUGH OPENING
FRAME SIZE
DAYLIGHT OPENING

21 1/4"(540)
24 5/16"(618)
18 3/4"(476)
18"(457)
13 1/16"(332)

23 1/4"(591)
26 5/16"(668)
20 3/4"(527)
20"(508)
15 1/16"(383)

27 1/4"(692)
30 5/16"(770)
24 3/4"(629)
24"(610)
19 1/16"(484)

31 1/4"(794)
34 5/16"(872)
28 3/4"(730)
28"(711)
23 1/16"(586)

33 1/4"(845)
36 5/16"(922)
30 3/4"(781)
30"(762)
25 1/16"(637)

35 1/4"(895)
38 5/16"(973)
32 3/4"(832)
32"(813)
27 1/16"(687)

39 1/4"(997)
42 5/16"(1075)
36 3/4"(933)
36"(914)
31 1/16"(789)

51 11/32"(1304)
52 7/8"(1343)
49 3/4"(1263)
48"(1219)
42 15/32"(1079)

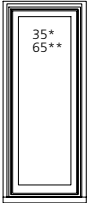

CWC1848

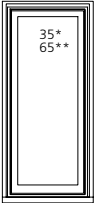

CWC2048

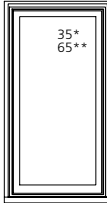

CWC2448

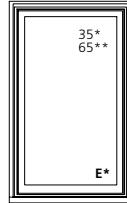

CWC2848

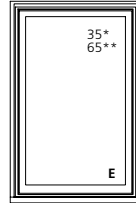

CWC3048

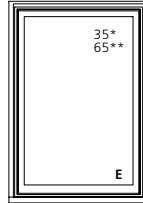

CWC3248

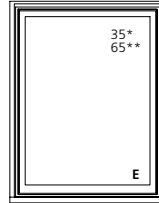

CWC3648

57 11/32"(1457)
58 7/8"(1495)
55 3/4"(1416)
54"(1372)
48 15/32"(1231)

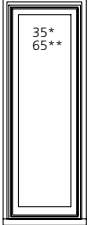

CWC1854

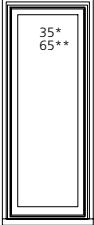

CWC2054

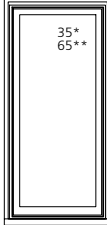

CWC2454

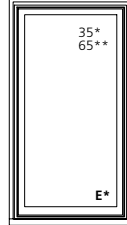

CWC2854

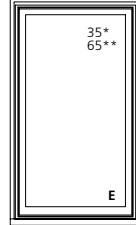

CWC3054

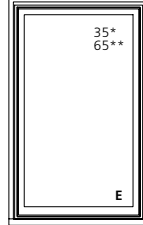

CWC3254

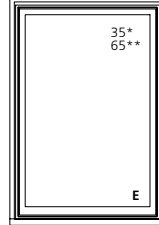

CWC3654

59 11/32"(1507)
60 7/8"(1546)
57 3/4"(1466)
56"(1422)
50 15/32"(1282)

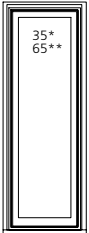

CWC1856

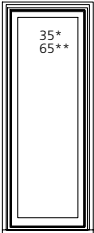

CWC2056

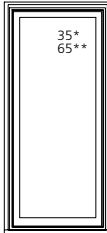

CWC2456

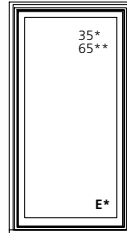

CWC2856

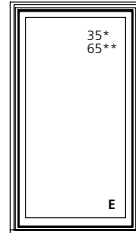

CWC3056

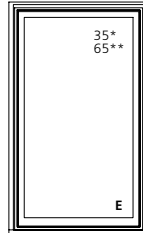

CWC3256

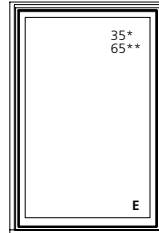

CWC3656

63 11/32"(1609)
64 7/8"(1648)
61 3/4"(1568)
60"(1524)
54 15/32"(1384)

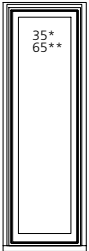

CWC1860

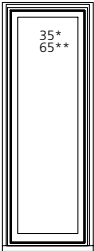

CWC2060

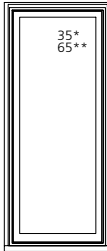

CWC2460

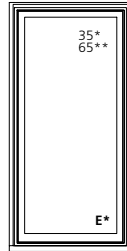

CWC2860

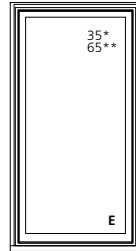

CWC3060

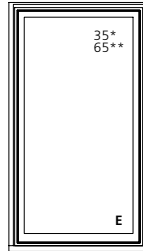

CWC3260

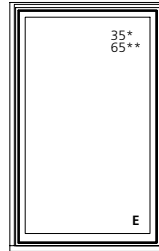

CWC3660

67 11/32"(1711)
68 7/8"(1749)
65 3/4"(1670)
64"(1626)
58 15/32"(1485)

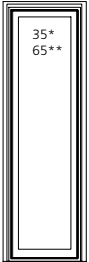

CWC1864

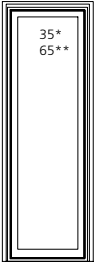

CWC2064

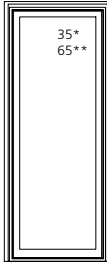

CWC2464

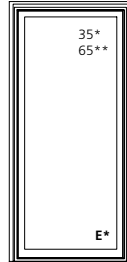

CWC2864

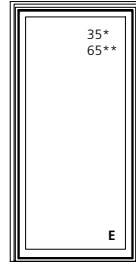

CWC3064

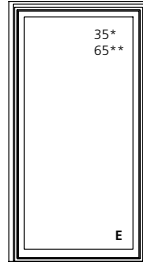

CWC3264

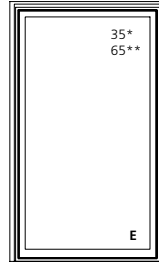

CWC3664

69 11/32"(1761)
70 7/8"(1800)
67 3/4"(1720)
66"(1676)
60 15/32"(1536)

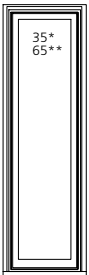

CWC1866

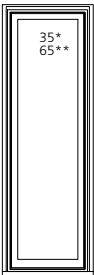

CWC2066

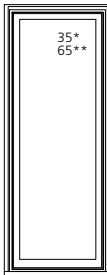

CWC2466

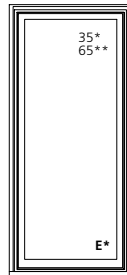

CWC2866

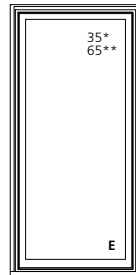

CWC3066

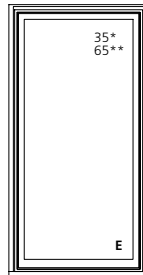

CWC3266

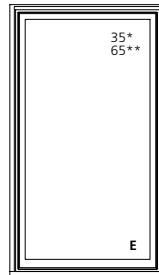

CWC3666

ELEVATION SYMBOL LEGEND:

M.O. = MASONRY OPENING

VALUES IN () ARE IN MILLIMETER CONVERSIONS

E BASIC UNIT CLEAR OPENING EXCEEDS 20" IN WIDTH, 24" IN HEIGHT & A MINIMUM OF 5.7 SQ. FT.

E* BASIC UNIT CLEAR OPENING REQUIRES EGRESS HINGES TO EXCEED 20" IN WIDTH, 24" IN HEIGHT & A MINIMUM, OF 5.7 SQ. FT.

*** NUMBER INDICATES DESIGN PRESSURE (DP) RATING WITH STANDARD GLAZING.

**** NUMBER INDICATES OPTIONAL DESIGN PRESSURE (DP) RATING.

Note: Elevations shown DO NOT have exterior trim. Subtract 1/2" (12.7) from M.O. (Masonry Opening) for Unit Sizes. Masonry Openings above include Sill Nose, see Trim Options page for Sill Nose specifications. For other Trim Options refer to the Unit Sizing, Rough Opening & Masonry Openings page.

SCALE: 1/4" = 1'

1-WIDE UNITS

M.O. BRICKMOUND	21 1/4"(540)	23 1/4"(591)	27 1/4"(692)	31 1/4"(794)	33 1/4"(845)	35 1/4"(895)	39 1/4"(997)
M.O. ADAMS/FLAT CASING	24 5/16"(618)	26 5/16"(668)	30 5/16"(770)	34 5/16"(872)	36 5/16"(922)	38 5/16"(973)	42 5/16"(1075)
ROUGH OPENING	18 3/4"(476)	20 3/4"(527)	24 3/4"(629)	28 3/4"(730)	30 3/4"(781)	32 3/4"(832)	36 3/4"(933)
FRAME SIZE	18"(457)	20"(508)	24"(610)	28"(711)	30"(762)	32"(813)	36"(914)
DAYLIGHT OPENING	13 1/16"(332)	15 1/16"(383)	19 1/16"(484)	23 1/16"(586)	25 1/16"(637)	27 1/16"(687)	31 1/16"(789)

75 11/32"(1914)
76 7/8"(1953)
73 3/4"(1873)
72"(1829)
66 15/32"(1688)

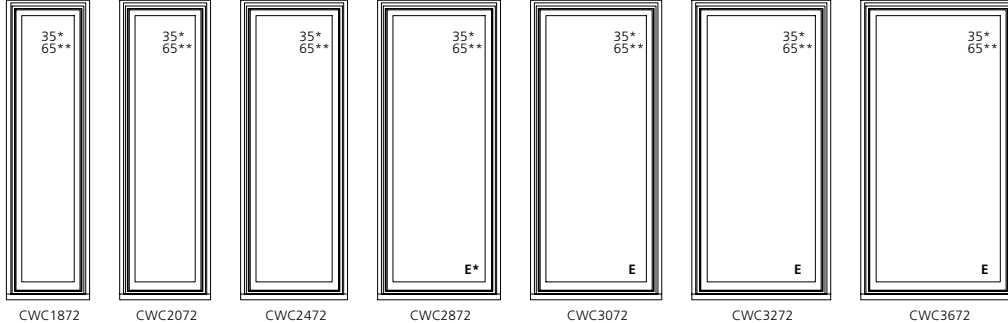

81 11/32"(2066)
82 7/8"(2105)
79 3/4"(2025)
78"(1981)
72 15/32"(1841)

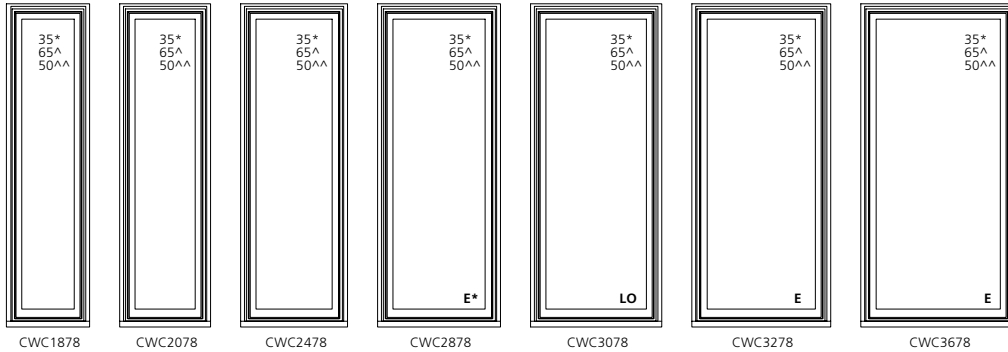

87 11/32"(2219)
88 7/8"(2257)
85 3/4"(2178)
84"(2134)
78 15/32"(1993)

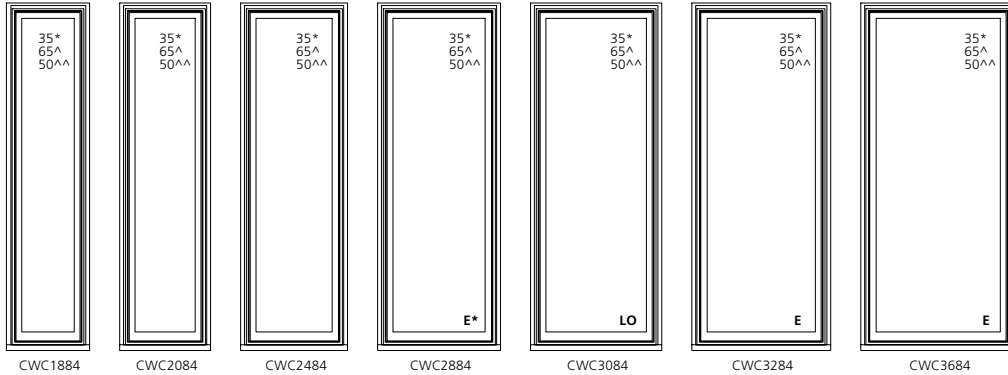

ELEVATION SYMBOL LEGEND:

- M.O.** = MASONRY OPENING
- VALUES IN () ARE IN MILLIMETER CONVERSIONS
- E** BASIC UNIT CLEAR OPENING EXCEEDS 20" IN WIDTH, 24" IN HEIGHT & A MINIMUM OF 5.7 SQ. FT.
- E*** BASIC UNIT CLEAR OPENING REQUIRES EGRESS HINGES TO EXCEED 20" IN WIDTH, 24" IN HEIGHT & A MINIMUM, OF 5.7 SQ. FT.
- LO** LIMITED OPERATION
- ##*** NUMBER INDICATES DESIGN PRESSURE (DP) RATING WITH STANDARD GLAZING.
- ###*** NUMBER INDICATES OPTIONAL DESIGN PRESSURE (DP) RATING.
- ##^** NUMBER INDICATES OPTIONAL DESIGN PRESSURE (DP) RATING ON STATIONARY UNITS.
- ##^^** NUMBER INDICATES OPTIONAL DESIGN PRESSURE (DP) RATING ON OPERATING UNITS.

Note: Elevations shown DO NOT have exterior trim. Subtract 1/2" (12.7) from M.O. (Masonry Opening) for Unit Sizes. Masonry Openings above include Sill Nose, see Trim Options page for Sill Nose specifications. For other Trim Options refer to the Unit Sizing, Rough Opening & Masonry Openings page.

SCALE: 1/4" = 1'

2-WIDE UNITS

M.O. BRICKMOULD	39 1/4"(997)	43 1/4"(1099)	51 1/4"(1302)	59 1/4"(1505)	63 1/4"(1607)	67 1/4"(1708)	75 1/4"(1911)
M.O. ADAMS/FLAT CASING	42 5/16"(1075)	46 5/16"(1176)	54 5/16"(1380)	62 5/16"(1583)	66 5/16"(1684)	70 5/16"(1786)	78 5/16"(1989)
ROUGH OPENING	36 3/4"(933)	40 3/4"(1035)	48 3/4"(1238)	56 3/4"(1441)	60 3/4"(1543)	64 3/4"(1645)	72 3/4"(1848)
FRAME SIZE	36"(914)	40"(1016)	48"(1219)	56"(1422)	60"(1524)	64"(1626)	72"(1829)
DAYLIGHT OPENING	13 1/16"[2](332) 2	15 1/16"[2](383) 2	19 1/16"[2](484) 2	23 1/16"[2](586) 2	25 1/16"[2](637) 2	27 1/16"[2](687) 2	31 1/16"[2](789) 2
21 11/32"(542) 22 7/8"(581) 19 3/4"(501) 18"(457) 12 15/32"(317)							
23 11/32"(593) 24 7/8"(632) 21 3/4"(552) 20"(508) 14 15/32"(367)							
27 11/32"(695) 28 7/8"(733) 25 3/4"(654) 24"(610) 18 15/32"(469)							
33 11/32"(847) 34 7/8"(886) 31 3/4"(806) 30"(762) 24 15/32"(622)							
35 11/32"(898) 36 7/8"(937) 33 3/4"(857) 32"(813) 26 15/32"(672)							
39 11/32"(999) 40 7/8"(1038) 37 3/4"(958) 36"(914) 30 15/32"(774)							
43 11/32"(1101) 44 7/8"(1140) 41 3/4"(1060) 40"(1016) 34 15/32"(876)							
45 11/32"(1152) 46 7/8"(1191) 43 3/4"(1111) 42"(1067) 36 15/32"(926)							
51 11/32"(1304) 52 7/8"(1343) 49 3/4"(1263) 48"(1219) 42 15/32"(1079)							
57 11/32"(1456) 58 7/8"(1495) 55 3/4"(1415) 54"(1372) 48 15/32"(1231)							
59 11/32"(1507) 60 7/8"(1546) 57 3/4"(1466) 56"(1422) 50 15/32"(1282)							
63 11/32"(1609) 64 7/8"(1648) 61 3/4"(1568) 60"(1524) 54 15/32"(1384)							

ELEVATION SYMBOL LEGEND:
M.O. = MASONRY OPENING
 VALUES IN () ARE IN MILLIMETER CONVERSIONS
 VALUES IN [] ARE NUMBER OF DAYLIGHT OPENINGS PER UNIT

Note: Elevations shown DO NOT have exterior trim. Subtract 1/2" (12.7) from M.O. (Masonry Opening) for Unit Sizes. Masonry Openings above include Sill Nose, see Trim Options page for Sill Nose specifications. For other Trim Options refer to the Unit Sizing, Rough Opening & Masonry Openings page.

SCALE: 1/8" = 1'

2-WIDE UNITS

M.O. BRICKMOULD	39 1/4" (997)	43 1/4" (1099)	51 1/4" (1302)	59 1/4" (1505)	63 1/4" (1607)	67 1/4" (1708)	75 1/4" (1911)
M.O. ADAMS/FLAT CASING	42 5/16" (1075)	46 5/16" (1176)	54 5/16" (1380)	62 5/16" (1583)	66 5/16" (1684)	70 5/16" (1786)	78 5/16" (1989)
ROUGH OPENING	36 3/4" (933)	40 3/4" (1035)	48 3/4" (1238)	56 3/4" (1441)	60 3/4" (1543)	64 3/4" (1645)	72 3/4" (1848)
FRAME SIZE	36" (914)	40" (1016)	48" (1219)	56" (1422)	60" (1524)	64" (1626)	72" (1829)
DAYLIGHT OPENING	13 1/16" [2] (332) [2]	15 1/16" [2] (383) [2]	19 1/16" [2] (484) [2]	23 1/16" [2] (586) [2]	25 1/16" [2] (637) [2]	27 1/16" [2] (687) [2]	31 1/16" [2] (789) [2]
67 11/32" (1711) 68 7/8" (1749) 65 3/4" (1670) 64" (1626) 58 15/32" (1485)							
CWC1864-2	CWC2064-2	CWC2464-2	CWC2864-2	CWC3064-2	CWC3264-2	CWC3664-2	
69 11/32" (1761) 70 7/8" (1800) 67 3/4" (1720) 66" (1676) 60 15/32" (1536)							
CWC1866-2	CWC2066-2	CWC2466-2	CWC2866-2	CWC3066-2	CWC3266-2	CWC3666-2	
75 11/32" (1914) 76 1/8" (1953) 73 1/2" (1873) 72" (1829) 66 15/32" (1688)							
CWC1872-2	CWC2072-2	CWC2472-2	CWC2872-2	CWC3072-2	CWC3272-2	CWC3672-2	
81 11/32" (2066) 82 7/8" (2105) 79 3/4" (2025) 78" (1981) 72 15/32" (1841)							
CWC1878-2	CWC2078-2	CWC2478-2	CWC2878-2	CWC3078-2			
87 11/32" (2219) 88 7/8" (2257) 85 3/4" (2178) 84" (2134) 78 15/32" (1993)							
CWC1884-2	CWC2084-2	CWC2484-2	CWC2884-2	CWC3084-2			

ELEVATION SYMBOL LEGEND:
M.O. = MASONRY OPENING
 VALUES IN () ARE IN MILLIMETER CONVERSIONS
 VALUES IN [] ARE NUMBER OF DAYLIGHT OPENINGS PER UNIT

Note: Elevations shown DO NOT have exterior trim. Subtract 1/2" (12.7) from M.O. (Masonry Opening) for Unit Sizes. Masonry Openings above include Sill Nose, see Trim Options page for Sill Nose specifications. For other Trim Options refer to the Unit Sizing, Rough Opening & Masonry Openings page.

SCALE: 1/8" = 1'

3-WIDE UNITS











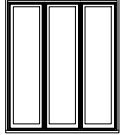
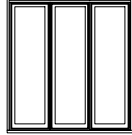
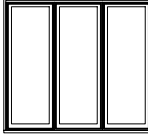
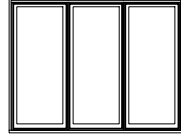
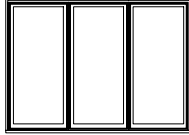
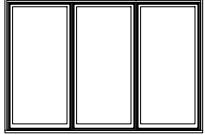
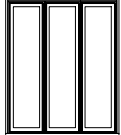
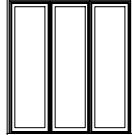
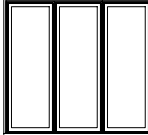
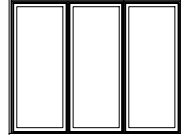
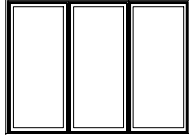
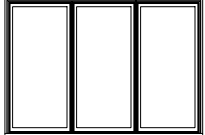
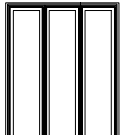

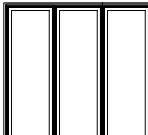

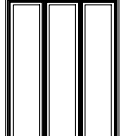
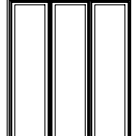
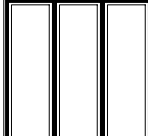

M.O. BRICKMOLD M.O. ADAMS/FLAT CASING ROUGH OPENING FRAME SIZE DAYLIGHT OPENING	57 1/4"(1454) 60 5/16"(1532) 54 3/4"(1391) 54"(1372)	63 1/4"(1607) 66 5/16"(1684) 60 3/4"(1543) 60"(1524)	75 1/4"(1911) 78 5/16"(1989) 72 3/4"(1848) 72"(1829)	87 1/4"(2216) 90 5/16"(2294) 84 3/4"(2153) 84"(2134)	93 1/4"(2369) 96 5/16"(2446) 90 3/4"(2305) 90"(2286)	99 1/4"(2521) 102 5/16"(2599) 96 3/4"(2457) 96"(2438)
	13 1/16"[3](332)[3]	15 1/16"[3](383)[3]	19 1/16"[3](484)[3]	23 1/16"[3](586)[3]	25 1/16"[3](637)[3]	27 1/16"[3](687)[3]
21 11/32"(542) 22 7/8"(591) 19 3/4"(501) 18"(457)	21 11/32"(593) 22 7/8"(632) 19 3/4"(552) 18"(508)	21 11/32"(695) 22 7/8"(733) 19 3/4"(654) 18"(610)	21 11/32"(849) 22 7/8"(886) 19 3/4"(806) 18"(762)	21 11/32"(999) 22 7/8"(1038) 19 3/4"(958) 18"(914)	21 11/32"(1152) 22 7/8"(1191) 19 3/4"(1111) 18"(1067)	21 11/32"(1304) 22 7/8"(1343) 19 3/4"(1263) 18"(1219)
12 15/32"(317)	14 15/32"(367)	18 15/32"(469)	24 15/32"(622)	30 15/32"(774)	36 15/32"(926)	42 15/32"(1079)
CWC1818-3	CWC2018-3	CWC2418-3	CWC2818-3	CWC3018-3		
CWC1820-3	CWC2020-3	CWC2420-3	CWC2820-3	CWC3020-3		
CWC1824-3	CWC2024-3	CWC2424-3	CWC2824-3	CWC3024-3		
CWC1830-3	CWC2030-3	CWC2430-3	CWC2830-3	CWC3030-3		
CWC1832-3	CWC2032-3	CWC2432-3	CWC2832-3	CWC3032-3		
CWC1836-3	CWC2036-3	CWC2436-3	CWC2836-3	CWC3036-3	CWC3236-3	
CWC1840-3	CWC2040-3	CWC2440-3	CWC2840-3	CWC3040-3	CWC3240-3	
CWC1842-3	CWC2042-3	CWC2442-3	CWC2842-3	CWC3042-3	CWC3242-3	
CWC1848-3	CWC2048-3	CWC2448-3	CWC2848-3	CWC3048-3	CWC3248-3	
CWC1854-3	CWC2054-3	CWC2454-3	CWC2854-3	CWC3054-3	CWC3254-3	
CWC1856-3	CWC2056-3	CWC2456-3	CWC2856-3	CWC3056-3	CWC3256-3	
CWC1860-3	CWC2060-3	CWC2460-3	CWC2860-3	CWC3060-3	CWC3260-3	

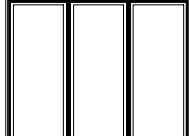
ELEVATION SYMBOL LEGEND:
M.O. = MASONRY OPENING
VALUES IN () ARE IN MILLIMETER CONVERSIONS
VALUES IN [] ARE NUMBER OF DAYLIGHT OPENINGS PER UNIT

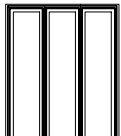
Note: Elevations shown DO NOT have exterior trim. Subtract 1/2" (12.7) from M.O. (Masonry Opening) for Unit Sizes. Masonry Openings above include Sill Nose, see Trim Options page for Sill Nose specifications. For other Trim Options refer to the Unit Sizing, Rough Opening & Masonry Openings page.

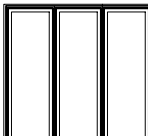
SCALE: 1/8" = 1'

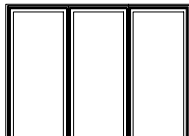
3-WIDE UNITS

	M.O. BRICKMOULD	57 1/4"(1454)	63 1/4"(1607)	75 1/4"(1911)	87 1/4"(2216)	93 1/4"(2369)	99 1/4"(2521)
	M.O. ADAMS/FLAT CASING	60 5/16"(1532)	66 5/16"(1684)	78 5/16"(1989)	90 5/16"(2294)	96 5/16"(2446)	102 5/16"(2599)
	ROUGH OPENING	54 3/4"(1391)	60 3/4"(1543)	72 3/4"(1848)	84 3/4"(2153)	90 3/4"(2305)	96 3/4"(2457)
	FRAME SIZE	54"(1372)	60"(1524)	72"(1829)	84"(2134)	90"(2286)	96"(2438)
	DAYLIGHT OPENING	13 1/16"[3](332)[3]	15 1/16"[3](383)[3]	19 1/16"[3](484)[3]	23 1/16"[3](586)[3]	25 1/16"[3](637)[3]	27 1/16"[3](687)[3]
67 11/32"(1711) 68 7/8"(1749) 65 3/4"(1670) 64"(1626) 58 15/32"(1485)							
	CWC1864-3	CWC2064-3	CWC2464-3	CWC2864-3	CWC3064-3	CWC3264-3	
69 11/32"(1761) 70 7/8"(1800) 67 3/4"(1720) 66"(1676) 60 15/32"(1536)							
	CWC1866-3	CWC2066-3	CWC2466-3	CWC2866-3	CWC3066-3	CWC3266-3	
75 11/32"(1914) 76 7/8"(1952) 73 3/4"(1873) 72"(1829) 66 15/32"(1688)							
	CWC1872-3	CWC2072-3	CWC2472-3	CWC2872-3	CWC3072-3	CWC3272-3	
81 11/32"(2066) 82 7/8"(2105) 79 3/4"(2025) 78"(1981) 72 15/32"(1841)							
	CWC1878-3	CWC2078-3	CWC2478-3	CWC2878-3	CWC3078-3	CWC3278-3	
87 11/32"(2219) 88 7/8"(2257) 85 3/4"(2178) 84"(2134) 78 15/32"(1993)							
	CWC1884-3	CWC2084-3	CWC2484-3	CWC2884-3	CWC3084-3	CWC3284-3	







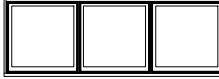

ELEVATION SYMBOL LEGEND:
M.O. = MASONRY OPENING
 VALUES IN () ARE IN MILLIMETER CONVERSIONS
 VALUES IN [] ARE NUMBER OF DAYLIGHT OPENINGS PER UNIT

Note: Elevations shown DO NOT have exterior trim. Subtract 1/2" (12.7) from M.O. (Masonry Opening) for Unit Sizes. Masonry Openings above include Sill Nose, see Trim Options page for Sill Nose specifications. For other Trim Options refer to the Unit Sizing, Rough Opening & Masonry Openings page.

SCALE: 1/8" = 1'

3-WIDE UNITS

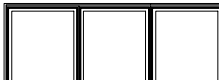
M.O. BRICKMOULD 111 1/4" (2826)
M.O. ADAMS/FLAT CASING 114 5/16" (2904)
ROUGH OPENING 108 3/4" (2762)
FRAME SIZE 108" (2743)
DAYLIGHT OPENING 31 1/16" [3] (789) [3]

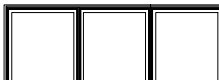
39 11/32" (999) 40 7/8" (1038) 37 3/4" (958) 36 (914) 30 15/32" (774)	
CWC3636-3	
43 11/32" (1101) 44 7/8" (1140) 41 3/4" (1060) 40 (1016) 34 15/32" (876)	
CWC3640-3	
45 11/32" (1152) 46 7/8" (1191) 43 3/4" (1111) 42 (1067) 36 15/32" (926)	
CWC3642-3	
51 11/32" (1304) 52 7/8" (1343) 49 3/4" (1263) 48 (1219) 42 15/32" (1079)	
CWC3648-3	
57 11/32" (1457) 58 7/8" (1495) 55 3/4" (1416) 54 (1372) 48 15/32" (1231)	
CWC3654-3	
59 11/32" (1507) 60 7/8" (1546) 57 3/4" (1466) 56 (1422) 50 15/32" (1282)	
CWC3656-3	
63 11/32" (1609) 64 7/8" (1648) 61 3/4" (1568) 60 (1524) 54 15/32" (1384)	
CWC3660-3	
67 11/32" (1711) 68 7/8" (1749) 65 3/4" (1670) 64 (1626) 58 15/32" (1485)	
CWC3664-3	
69 11/32" (1761) 70 7/8" (1800) 67 3/4" (1720) 66 (1676) 60 15/32" (1536)	
CWC3666-3	
75 11/32" (1914) 76 7/8" (1952) 73 3/4" (1873) 72 (1829) 66 15/32" (1688)	
CWC3672-3	

ELEVATION SYMBOL LEGEND:
M.O. = MASONRY OPENING
VALUES IN () ARE IN MILLIMETER CONVERSIONS
VALUES IN [] ARE NUMBER OF DAYLIGHT OPENINGS PER UNIT

Note: Elevations shown DO NOT have exterior trim. Subtract 1/2" (12.7) from M.O. (Masonry Opening) for Unit Sizes. Masonry Openings above include Sill Nose, see Trim Options page for Sill Nose specifications. For other Trim Options refer to the Unit Sizing, Rough Opening & Masonry Openings page.

SCALE: 1/8" = 1'

PICTURE UNITS

M.O. BRICKMOULD
M.O. ADAMS/FLAT CASING
ROUGH OPENING
FRAME SIZE
DAYLIGHT OPENING

43 1/4"(1099)
46 5/16"(1176)
40 3/4"(1035)
40"(1016)
35 1/16"(891)

45 1/4"(1149)
48 5/16"(1227)
42 3/4"(1086)
42"(1067)
37 1/16"(941)

51 1/4"(1302)
54 5/16"(1380)
48 3/4"(1238)
48"(1219)
43 1/16"(1094)

57 1/4"(1454)
60 5/16"(1532)
54 3/4"(1391)
54"(1372)
49 1/16"(1246)

59 1/4"(1505)
62 5/16"(1583)
56 3/4"(1441)
56"(1422)
51 1/16"(1297)

57 11/32"(1457)
58 7/8"(1495)
55 3/4"(1416)
54"(1372)
48 15/32"(1231)

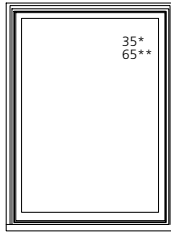

CWCP4054

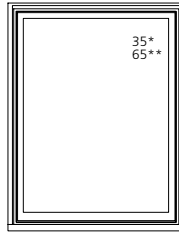

CWCP4254

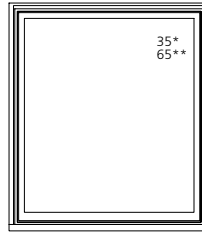

CWCP4854

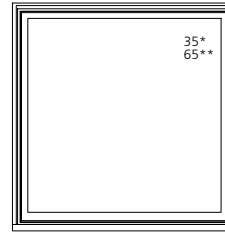

CWCP54054

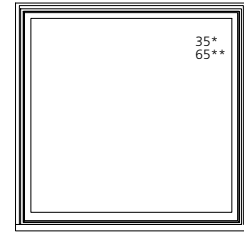

CWCP5654

59 11/32"(1507)
60 7/8"(1546)
57 3/4"(1466)
56"(1422)
50 15/32"(1282)

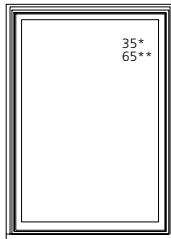

CWCP4056

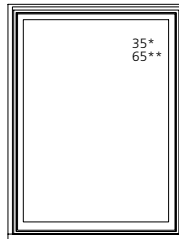

CWCP4256

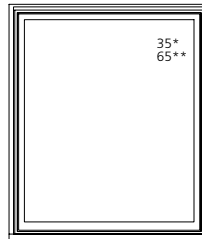

CWCP4856

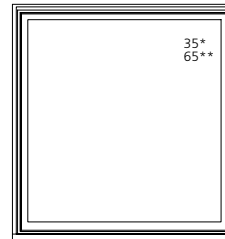

CWCP54056

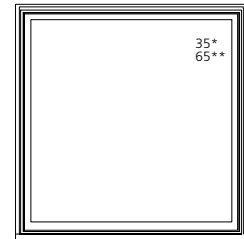

CWCP5656

63 11/32"(1609)
64 7/8"(1648)
61 3/4"(1568)
60"(1524)
54 15/32"(1384)

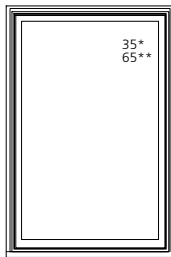

CWCP4060

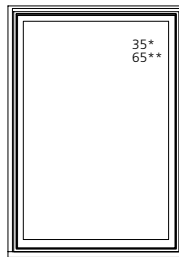

CWCP4260

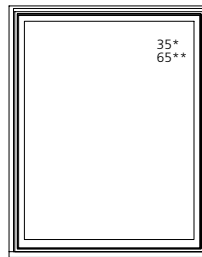

CWCP4860

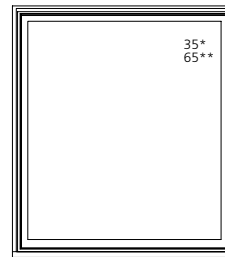

CWCP54060

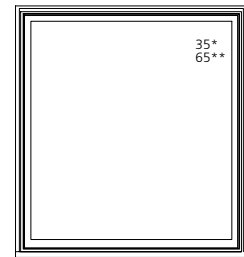

CWCP5660

67 11/32"(1711)
68 7/8"(1749)
65 3/4"(1670)
64"(1626)
58 15/32"(1485)

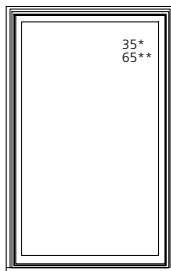

CWCP4064

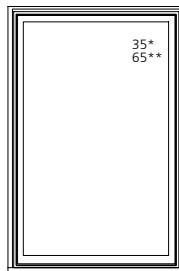

CWCP4264

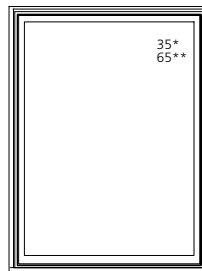

CWCP4864

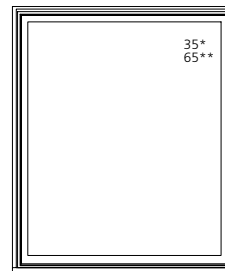

CWCP54064

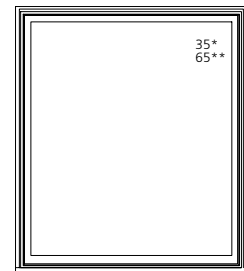

CWCP5664

69 11/32"(1761)
70 7/8"(1800)
67 3/4"(1720)
66"(1676)
60 15/32"(1536)

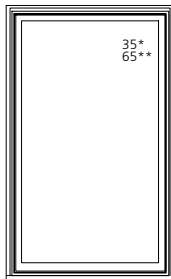

CWCP4066

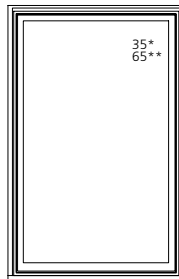

CWCP4266

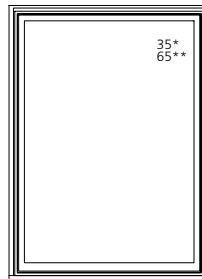

CWCP4866

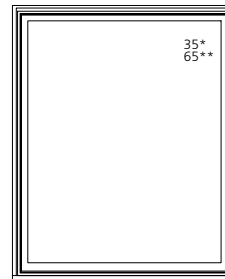

CWCP54066

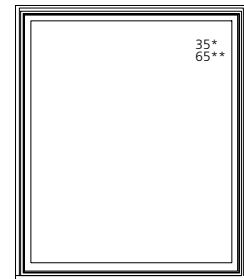

CWCP5666

ELEVATION SYMBOL LEGEND:

M.O. = MASONRY OPENING

VALUES IN () ARE IN MILLIMETER CONVERSIONS

##* NUMBER INDICATES DESIGN PRESSURE (DP) RATING WITH STANDARD GLAZING.

###* NUMBER INDICATES OPTIONAL DESIGN PRESSURE (DP) RATING.

Note: Elevations shown DO NOT have exterior trim. Subtract 1/2" (12.7) from M.O. (Masonry Opening) for Unit Sizes. Masonry Openings above include Sill Nose, see Trim Options page for Sill Nose specifications. For other Trim Options refer to the Unit Sizing, Rough Opening & Masonry Openings page.

SCALE: 1/4" = 1'

PICTURE UNITS

M.O. BRICKMOULD
M.O. ADAMS/FLAT CASING
ROUGH OPENING
FRAME SIZE
DAYLIGHT OPENING

43 1/4"(1099)
46 5/16"(1176)
40 3/4"(1035)
40"(1016)
35 1/16"(891)

45 1/4"(1149)
48 5/16"(1227)
42 3/4"(1086)
42"(1067)
37 1/16"(941)

51 1/4"(1302)
54 5/16"(1380)
48 3/4"(1238)
48"(1219)
43 1/16"(1094)

57 1/4"(1454)
60 5/16"(1532)
54 3/4"(1391)
54"(1372)
49 1/16"(1246)

59 1/4"(1505)
62 5/16"(1583)
56 3/4"(1441)
56"(1422)
51 1/16"(1297)

75 1 1/32"(1914)
76 7/8"(1953)
73 3/4"(1873)
72"(1829)
66 15/32"(1688)

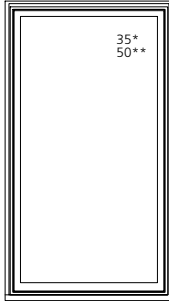

CWCP4072

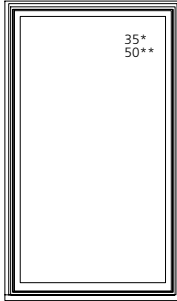

CWCP4272

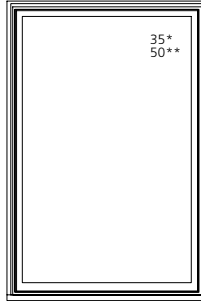

CWCP4872

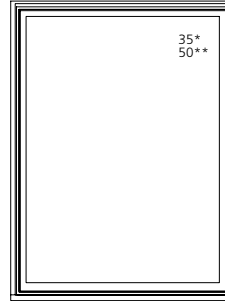

CWCP54072

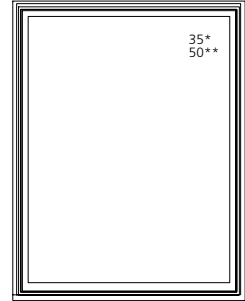

CWCP5672

81 11/32"(2066)
82 7/8"(2105)
79 3/4"(2025)
78"(1981)
72 15/32"(1841)

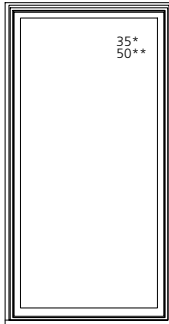

CWCP4078

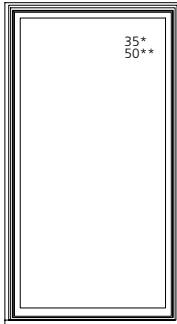

CWCP4278

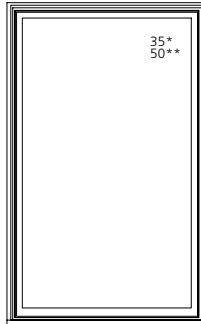

CWCP4878

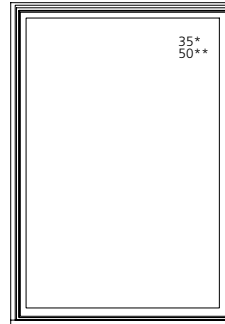

CWCP54078

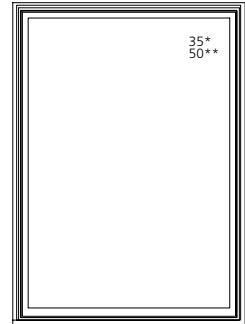

CWCP5678

87 11/32"(2219)
88 7/8"(2257)
85 3/4"(2178)
84"(2134)
78 15/32"(1993)

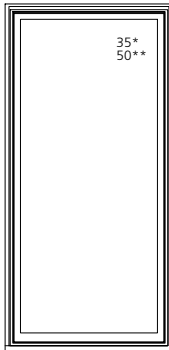

CWCP4084

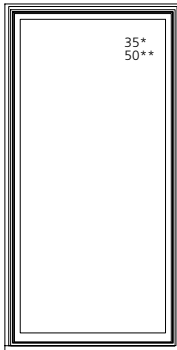

CWCP4284

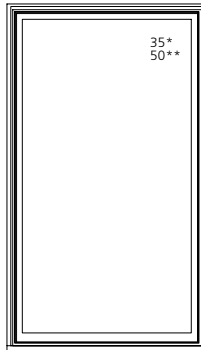

CWCP4884

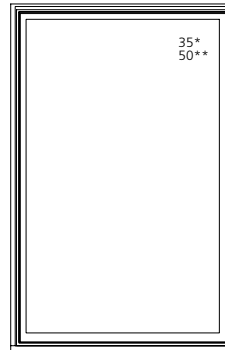

CWCP54084

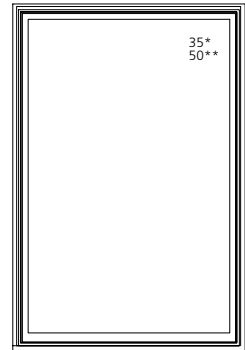

CWCP5684

ELEVATION SYMBOL LEGEND:

M.O. = MASONRY OPENING
VALUES IN () ARE IN MILLIMETER CONVERSIONS

NUMBER INDICATES DESIGN PRESSURE (DP) RATING WITH STANDARD GLAZING.

NUMBER INDICATES OPTIONAL DESIGN PRESSURE (DP) RATING.

Note: Elevations shown DO NOT have exterior trim. Subtract 1/2" (12.7) from M.O. (Masonry Opening) for Unit Sizes. Masonry Openings above include Sill Nose, see Trim Options page for Sill Nose specifications. For other Trim Options refer to the Unit Sizing, Rough Opening & Masonry Openings page.

SCALE: 1/4" = 1'

PICTURE UNITS

M.O. BRICKMOULD
M.O. ADAMS/FLAT CASING
ROUGH OPENING
FRAME SIZE
DAYLIGHT OPENING

63 1/4" (1607)
66 5/16" (1687)
60 3/4" (1543)
60" (1524)
55 1/16" (1399)

69 1/4" (1759)
72 5/16" (1837)
66 3/4" (1695)
66" (1676)
61 1/16" (1526)

75 1/4" (1911)
78 5/16" (1989)
72 3/4" (1848)
72" (1829)
67 1/16" (1703)

57 11/32" (1457)
58 7/8" (1495)
55 3/4" (1416)
54" (1372)
48 15/32" (1231)

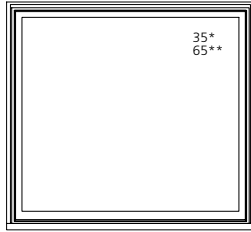

CWCP6054

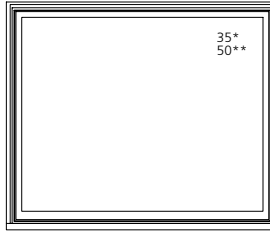

CWCP6654

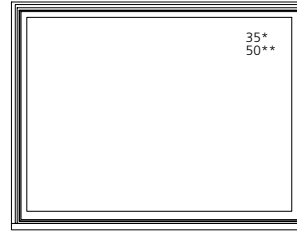

CWCP7254

59 11/32" (1507)
60 7/8" (1546)
57 3/4" (1466)
56" (1422)
50 15/32" (1282)

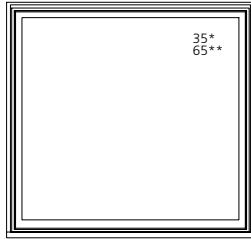

CWCP6056

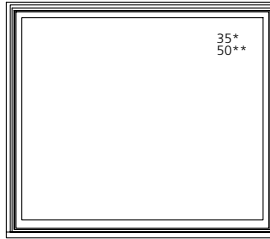

CWCP6656

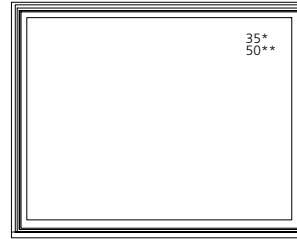

CWCP7256

63 11/32" (1609)
64 7/8" (1648)
61 3/4" (1568)
60" (1524)
54 15/32" (1384)

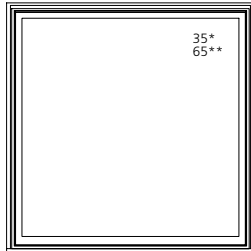

CWCP6060

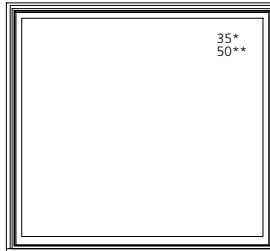

CWCP6660

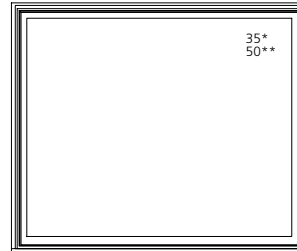

CWCP7260

67 11/32" (1711)
68 7/8" (1749)
65 3/4" (1670)
64" (1626)
58 15/32" (1485)

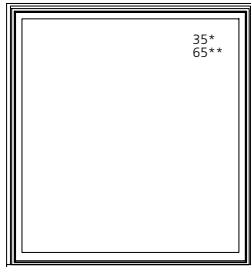

CWCP6064

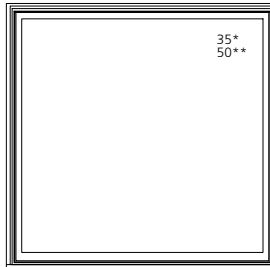

CWCP6664

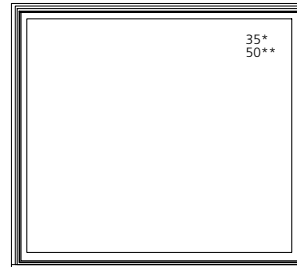

CWCP7264

69 11/32" (1761)
70 7/8" (1800)
67 3/4" (1720)
66" (1676)
60 15/32" (1536)

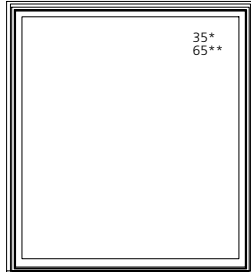

CWCP6066

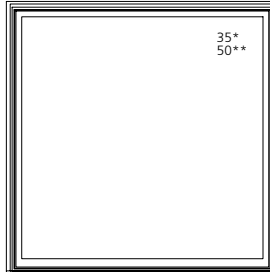

CWCP6666

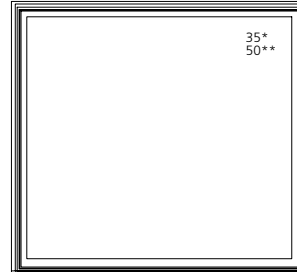

CWCP7266

ELEVATION SYMBOL LEGEND:

M.O. = MASONRY OPENING

VALUES IN () ARE IN MILLIMETER CONVERSIONS

NUMBER INDICATES DESIGN PRESSURE (DP) RATING WITH STANDARD GLAZING.

NUMBER INDICATES OPTIONAL DESIGN PRESSURE (DP) RATING.

Note: Elevations shown DO NOT have exterior trim. Subtract 1/2" (12.7) from M.O. (Masonry Opening) for Unit Sizes. Masonry Openings above include Sill Nose, see Trim Options page for Sill Nose specifications. For other Trim Options refer to the Unit Sizing, Rough Opening & Masonry Openings page.

SCALE: 1/4" = 1'

PICTURE UNITS

**M.O. BRICKMOUND
M.O. ADAMS/FLAT CASING
ROUGH OPENING
FRAME SIZE
DAYLIGHT OPENING**

63 1/4"(1607)
66 5/16"(1687)
60 3/4"(1543)
60"(1524)
55 1/16"(1399)

69 1/4"(1759)
72 5/16"(1837)
66 3/4"(1695)
66"(1676)
61 1/16"(1526)

75 1/4"(1911)
78 5/16"(1989)
72 3/4"(1848)
72"(1829)
67 1/16"(1703)

75 11/32"(1914)
76 7/8"(1953)
73 3/4"(1873)
72"(1829)
66 15/32"(1688)

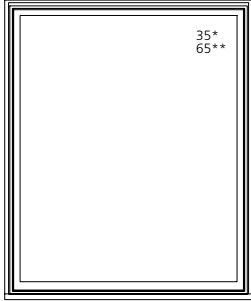

CWCP6072

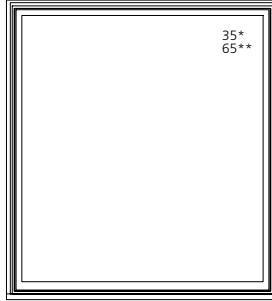

CWCP6672

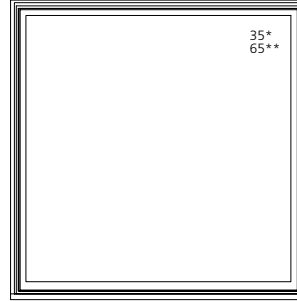

CWCP7272

81 11/32"(2066)
82 7/8"(2105)
79 3/4"(2025)
78"(1981)
72 15/32"(1841)

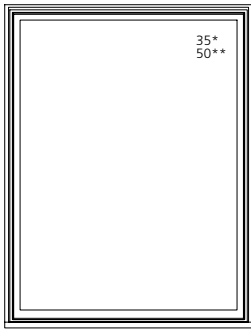

CWCP6078

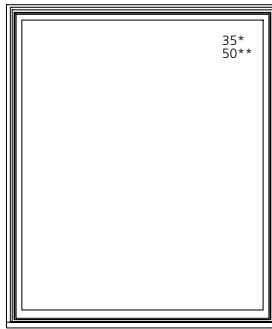

CWCP6678

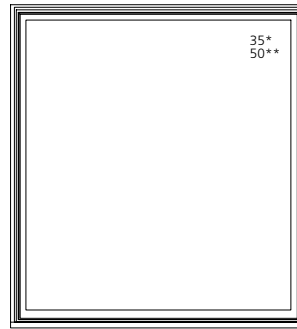

CWCP7278

87 11/32"(2219)
88 7/8"(2257)
85 3/4"(2178)
84"(2134)
78 15/32"(1993)

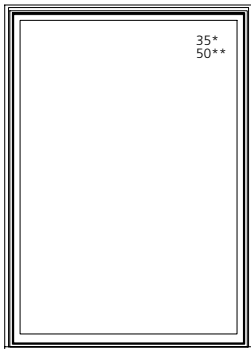

CWCP6084

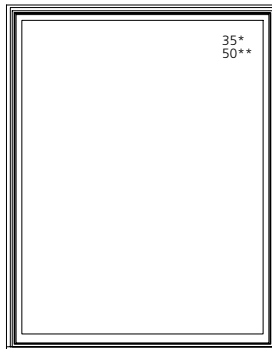

CWCP6684

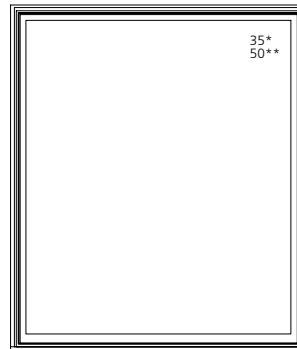

CWCP7284

ELEVATION SYMBOL LEGEND:

M.O. = MASONRY OPENING
VALUES IN () ARE IN MILLIMETER CONVERSIONS
##* NUMBER INDICATES DESIGN PRESSURE (DP) RATING WITH STANDARD GLAZING.
###* NUMBER INDICATES OPTIONAL DESIGN PRESSURE (DP) RATING.

Note: Elevations shown DO NOT have exterior trim. Subtract 1/2" (12.7) from M.O. (Masonry Opening) for Unit Sizes. Masonry Openings above include Sill Nose, see Trim Options page for Sill Nose specifications. For other Trim Options refer to the Unit Sizing, Rough Opening & Masonry Openings page.

SCALE: 1/4" = 1'

GENERAL INFORMATION
SECTOR TOP CASEMENTS

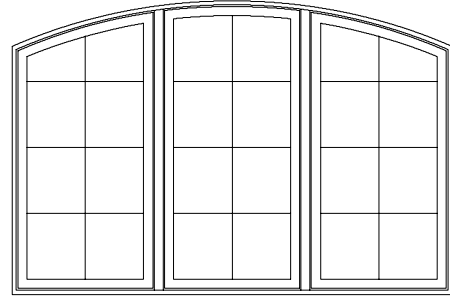
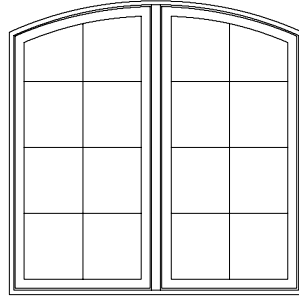
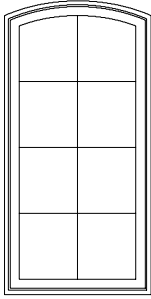

Sector wood casements are constructed the same as Custom Wood casements, roll formed cladding on wood sash.

Sector wood casement windows are available with left or right hand operation (hinged on the springline), or stationary (non-venting). Operating mechanism includes stainless steel, corrosion resistant, butt hinges and single arm roto-type operator with hardened steel gears and operating arm. Sash locks are concealed unison type with an exposed locking lever and escutcheon plate. There are several interior hardware finish options. Refer to the Specifications for finish options.

WOOD SECTOR TOP CASEMENTS utilize some of the same options as WOOD CUSTOM CASEMENTS.

**HANDING, OPERATION & LIMIT DEVICE
SECTOR TOP CASEMENTS**

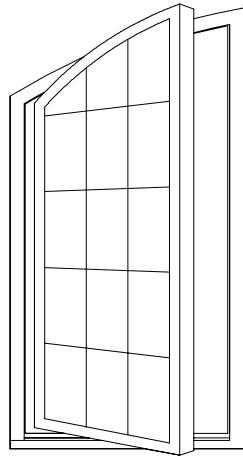

**LEFT
HAND**

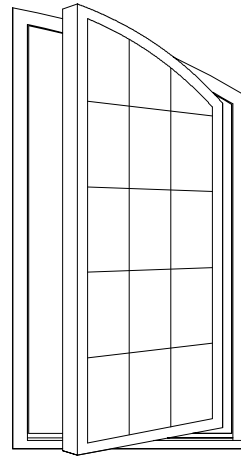

**RIGHT
HAND**

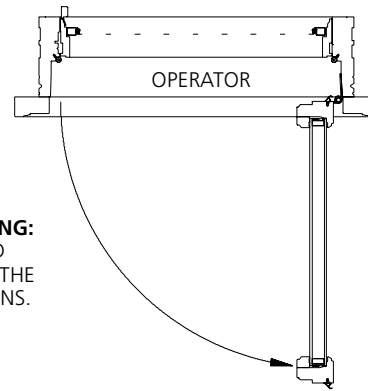
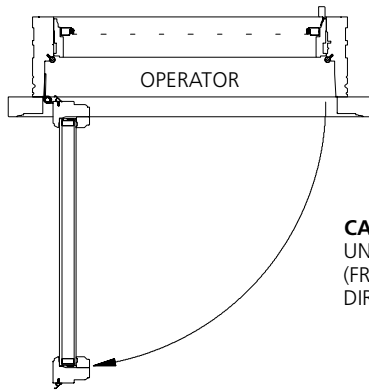

CASEMENT UNIT HANDING:
UNIT HANDING IS DEFINED
(FROM THE EXTERIOR) AS THE
DIRECTION THE SASH OPENS.

UNIT HANDING INFORMATION

- OPERATING SINGLE SECTOR UNITS - MAY BE HANDED 'LEFT' OR 'RIGHT'.
- OPERATING TWIN SECTOR UNITS - THESE UNITS ARE HINGED ON THE SPRINGLINE SIDE. THE 'LEFT' SASH HAS 'LEFT' HAND OPERATION AND THE 'RIGHT' SASH HAS 'RIGHT' HAND OPERATION ONLY.
- OPERATING TRIPLE SECTOR UNITS - ONLY THE FLANKING UNITS MAY BE OPERATORS WHICH ARE HINGED ON THE SPRINGLINE SIDE. THE TWO OPERATING SASH ARE HANDED THE SAME AS THE TWIN SECTOR.

ELEVATION NOTES
SECTOR TOP CASEMENTS

ELEVATION DRAWINGS UTILIZE A LIMITED NUMBER OF PROJECTED LINES TO PRODUCE A RUDIMENTARY DRAWING INTENDED TO BE USED IN A SMALL GRAPHICAL SCALE. ELEVATIONS ARE VIEWED PERPENDICULAR FROM THE EXTERIOR OF THE STRUCTURE. IF MORE DIMENSIONS ARE NEEDED, USE THE SECTION DRAWINGS FOR MORE COMPLETE DEPICTIONS.

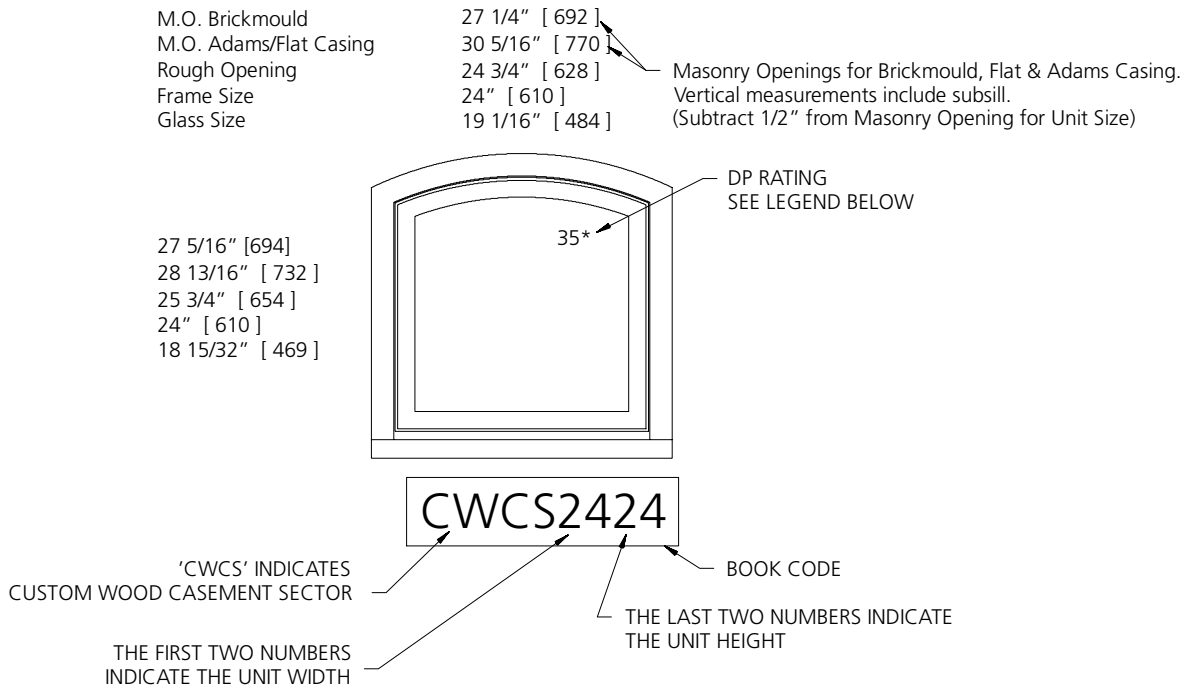

GENERAL RADIUS CASEMENT NOTES

1. UNIT ELEVATIONS ARE SHOWN WITH BRICKMOULD AND SUBSILL.
2. DIMENSIONAL VALUES IN BRACKETS ARE MILLIMETER CONVERSIONS.
3. ALL SECTOR UNITS ARE AVAILABLE AS OPERATING UNITS.

ELEVATION SYMBOL LEGEND:

- | | |
|------------|---|
| E | BASIC UNIT CLEAR OPENING EXCEEDS 20" IN WIDTH, 24" IN HEIGHT & A MINIMUM OF 5.7 SQ. FT. |
| LO | LIMITED OPERATION |
| ##* | NUMBER INDICATES DESIGN PRESSURE (DP) RATING WITH STANDARD GLAZING. |

SECTOR TOP - 1-WIDE UNITS

M.O. BRICKMOULD
M.O. ADAMS/FLAT CASING
ROUGH OPENING
FRAME SIZE
DAYLIGHT OPENING

27 1/4" (692)
30 5/16" (770)
24 3/4" (629)
24" (610)
19 1/16" (484)

33 1/4" (845)
36 5/16" (922)
30 3/4" (781)
30" (762)
25 1/16" (637)

27 11/32" (695)
28 7/8" (733)
25 3/4" (654)
24" (610)
18 15/32" (469)



CWCS2424

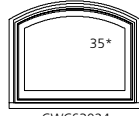

CWCS3024

33 11/32" (847)
34 7/8" (886)
31 3/4" (806)
30" (762)
24 15/32" (622)

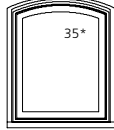

CWCS2430

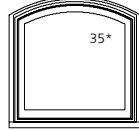

CWCS3030

35 11/32" (898)
36 7/8" (937)
33 3/4" (857)
32" (813)
26 15/32" (672)

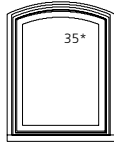

CWCS2432

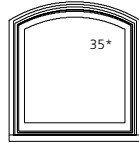

CWCS3032

39 11/32" (999)
40 7/8" (1038)
37 3/4" (958)
36" (914)
30 15/32" (774)

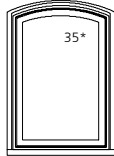

CWCS2436

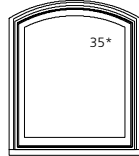

CWCS3036

43 11/32" (1101)
44 7/8" (1140)
41 3/4" (1060)
40" (1016)
34 15/32" (876)

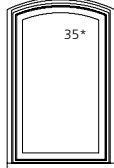

CWCS2440

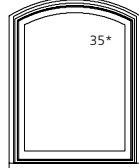

CWCS3040

45 11/32" (1152)
46 7/8" (1191)
43 3/4" (1111)
42" (1067)
36 15/32" (926)

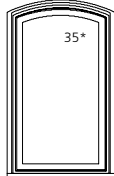

CWCS2442

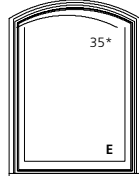

CWCS3042

51 11/32" (1304)
52 7/8" (1343)
49 3/4" (1263)
48" (1219)
42 15/32" (1079)

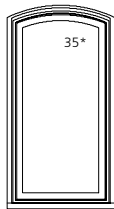

CWCS2448

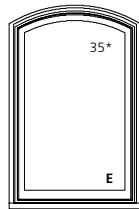

CWCS3048

M.O. BRICKMOULD
M.O. ADAMS/FLAT CASING
ROUGH OPENING
FRAME SIZE
DAYLIGHT OPENING

27 1/4" (692)
30 5/16" (770)
24 3/4" (629)
24" (610)
19 1/16" (484)

33 1/4" (845)
36 5/16" (922)
30 3/4" (781)
30" (762)
25 1/16" (637)

57 11/32" (1457)
58 7/8" (1495)
55 3/4" (1416)
54" (1372)
48 15/32" (1231)

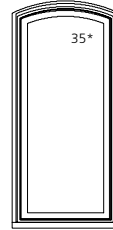

CWCS2454

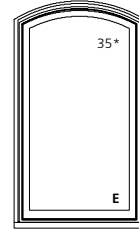

CWCS3054

59 11/32" (1507)
60 7/8" (1546)
57 3/4" (1466)
56" (1422)
50 15/32" (1282)

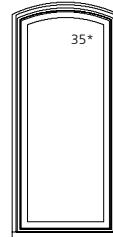

CWCS2456

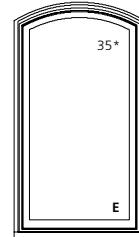

CWCS3056

63 11/32" (1609)
64 7/8" (1648)
61 3/4" (1568)
60" (1524)
54 15/32" (1384)

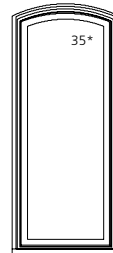

CWCS2460

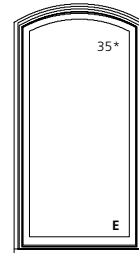

CWCS3060

67 11/32" (1711)
68 7/8" (1749)
65 3/4" (1670)
64" (1626)
58 15/32" (1485)

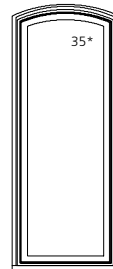

CWCS2464

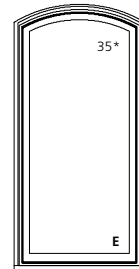

CWCS3064

ELEVATION SYMBOL LEGEND:

M.O. = MASONRY OPENING
VALUES IN () ARE IN MILLIMETER CONVERSIONS
E BASIC UNIT CLEAR OPENING EXCEEDS 20" IN WIDTH, 24" IN HEIGHT & A MINIMUM OF 5.7 SQ. FT.
##* = NUMBER INDICATES DESIGN PRESSURE (DP) RATING WITH STANDARD GLAZING.

Note: Elevations shown DO NOT have exterior trim. Subtract 1/2" (12.7) from M.O. (Masonry Opening) for Unit Sizes. Masonry Openings above include Sill Nose, see Trim Options page for Sill Nose specifications. For other Trim Options refer to the Unit Sizing, Rough Opening & Masonry Openings page.

SCALE: 1/4" = 1'

SECTOR TOP - 1-WIDE UNITS

M.O. BRICKMOULD	27 1/4" (692)	33 1/4" (845)
M.O. ADAMS/FLAT CASING	30 5/16" (770)	36 5/16" (922)
ROUGH OPENING	24 3/4" (629)	30 3/4" (781)
FRAME SIZE	24" (610)	30" (762)
DAYLIGHT OPENING	19 1/16" (484)	25 1/16" (637)

69 11/32" (1761)
70 7/8" (1800)
67 3/4" (1720)
66" (1676)
60 13/32" (1536)

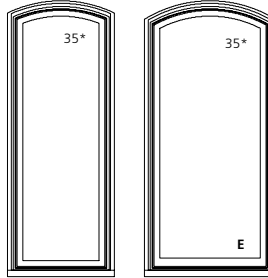

CWCS2466

CWCS3066

75 11/32" (1914)
76 7/8" (1953)
75 3/4" (1873)
72" (1829)
66 13/32" (1688)

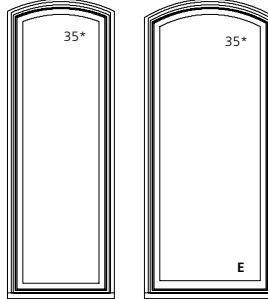

CWCS2472

CWCS3072

81 11/32" (2066)
82 7/8" (2105)
79 3/4" (2025)
78" (1981)
72 13/32" (1841)

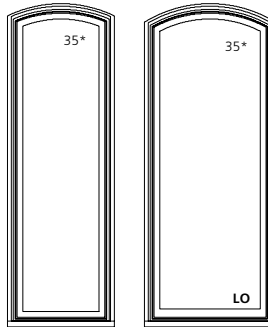

CWCS2478

CWCS3078

87 11/32" (2219)
88 7/8" (2257)
85 3/4" (2178)
84" (2134)
78 13/32" (1993)

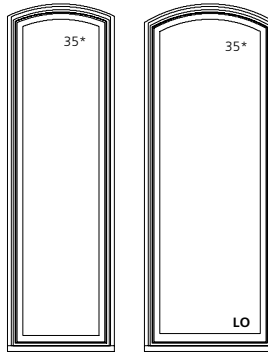

CWCS2484

CWCS3084

ELEVATION SYMBOL LEGEND:

M.O. = MASONRY OPENING
VALUES IN () ARE IN MILLIMETER CONVERSIONS
E BASIC UNIT CLEAR OPENING EXCEEDS 20" IN WIDTH, 24" IN HEIGHT & A MINIMUM OF 5.7 SQ. FT.
LO LIMITED OPERATION
NUMBER INDICATES DESIGN PRESSURE (DP) RATING WITH STANDARD GLAZING.

Note: Elevations shown DO NOT have exterior trim. Subtract 1/2" (12.7) from M.O. (Masonry Opening) for Unit Sizes. Masonry Openings above include Sill Nose, see Trim Options page for Sill Nose specifications. For other Trim Options refer to the Unit Sizing, Rough Opening & Masonry Openings page.

SCALE: 1/4" = 1'

SECTOR TOP - 2-WIDE UNITS

M.O. BRICKMOULD
M.O. ADAMS/FLAT CASING
ROUGH OPENING
FRAME SIZE
DAYLIGHT OPENING

51 1/4" (1302)
54 5/16" (1380)
48 3/4" (1238)
48" (1219)
19 1/16" [2] (484) [2]

63 1/4" (1607)
66 5/16" (1684)
60 3/4" (1543)
60" (1524)
25 1/16" [2] (637) [2]

27 11/32" (695)
28 7/8" (733)
25 3/4" (654)
24" (610)
18 15/32" (469)
33 11/32" (847)
34 7/8" (886)
31 3/4" (806)
30" (762)
24 15/32" (622)
35 11/32" (898)
36 7/8" (937)
33 3/4" (857)
33 3/4" (813)
26 15/32" (672)
39 11/32" (999)
40 7/8" (1038)
37 3/4" (958)
36" (914)
30 15/32" (774)
43 11/32" (1101)
44 7/8" (1140)
41 3/4" (1060)
40" (1016)
34 15/32" (876)
45 11/32" (1152)
46 7/8" (1191)
43 3/4" (1111)
42" (1067)
36 15/32" (926)
51 11/32" (1304)
52 7/8" (1343)
49 3/4" (1263)
48" (1219)
42 15/32" (1079)
57 11/32" (1457)
58 7/8" (1495)
55 3/4" (1416)
54" (1372)
48 15/32" (1231)
59 11/32" (1507)
60 7/8" (1546)
57 3/4" (1466)
56" (1422)
50 15/32" (1282)
63 11/32" (1609)
64 7/8" (1648)
61 3/4" (1568)
60" (1524)
54 15/32" (1384)

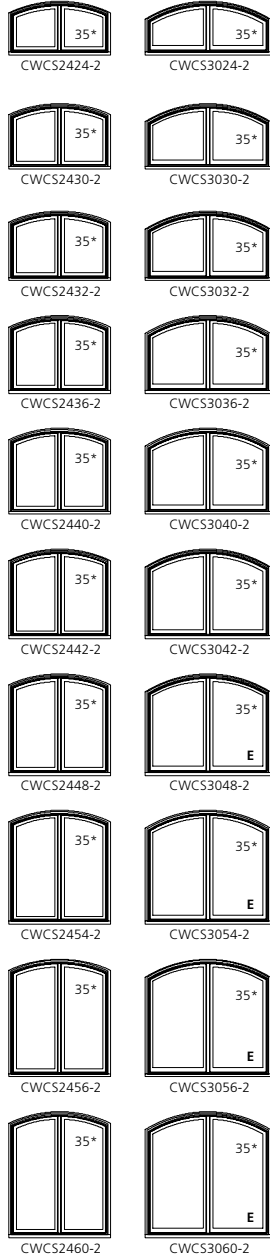

M.O. BRICKMOULD
M.O. ADAMS/FLAT CASING
ROUGH OPENING
FRAME SIZE
DAYLIGHT OPENING

51 1/4" (1302)
54 5/16" (1380)
48 3/4" (1238)
48" (1219)
19 1/16" [2] (484) [2]

63 1/4" (1607)
66 5/16" (1684)
60 3/4" (1543)
60" (1524)
25 1/16" [2] (637) [2]

67 11/32" (1711)
68 7/8" (1749)
65 3/4" (1670)
64" (1626)
58 15/32" (1485)
69 11/32" (1761)
70 7/8" (1800)
67 3/4" (1720)
66" (1676)
60 15/32" (1536)
75 11/32" (1914)
76 7/8" (1953)
73 3/4" (1873)
72" (1829)
66 15/32" (1688)
81 11/32" (2066)
82 7/8" (2105)
79 3/4" (2025)
78" (1981)
72 15/32" (1841)
87 11/32" (2219)
88 7/8" (2257)
85 3/4" (2178)
84" (2134)
78 15/32" (1983)

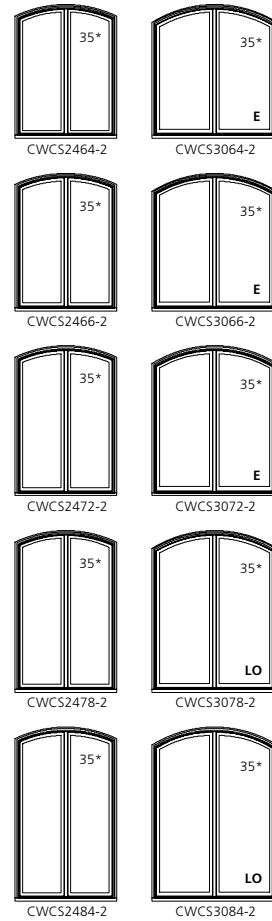

ELEVATION SYMBOL LEGEND:

M.O. = MASONRY OPENING
VALUES IN () ARE IN MILLIMETER CONVERSIONS
VALUES IN [] ARE NUMBER OF DAYLIGHT OPENINGS PER UNIT
E BASIC UNIT CLEAR OPENING EXCEEDS 20" IN WIDTH, 24" IN HEIGHT & A MINIMUM OF 5.7 SQ. FT.
LO LIMITED OPERATION
NUMBER INDICATES DESIGN PRESSURE (DP) RATING WITH STANDARD GLAZING.

Note: Elevations shown DO NOT have exterior trim. Subtract 1/2" (12.7) from M.O. (Masonry Opening) for Unit Sizes. Masonry Openings above include Sill Nose, see Trim Options page for Sill Nose specifications. For other Trim Options refer to the Unit Sizing, Rough Opening & Masonry Openings page.

SCALE: 1/8" = 1'

SECTOR TOP - 3-WIDE UNITS

M.O. BRICKMOULD
M.O. ADAMS/FLAT CASING
ROUGH OPENING
FRAME SIZE
DAYLIGHT OPENING

75 1/4" (1911)
78 5/16" (1989)
72 3/4" (1848)
72" (1829)
31 1/16" [3] (789) [3]

93 1/4" (2369)
96 5/16" (2446)
90 3/4" (2305)
90" (2286)
25 1/16" [3] (637) [3]

M.O. BRICKMOULD
M.O. ADAMS/FLAT CASING
ROUGH OPENING
FRAME SIZE
DAYLIGHT OPENING

75 1/4" (1911)
78 5/16" (1989)
72 3/4" (1848)
72" (1829)
31 1/16" [3] (789) [3]

93 1/4" (2369)
96 5/16" (2446)
90 3/4" (2305)
90" (2286)
25 1/16" [3] (637) [3]

27 11/32" (695)
28 7/8" (733)
29 3/4" (654)
34 1/8" (866)
31 3/4" (806)
30 7/8" (762)
33 1 1/32" (847)
34 7/8" (886)
31 3/4" (806)
30 7/8" (762)
35 1 1/32" (898)
36 7/8" (937)
33 3/4" (857)
32 (813)
39 1 1/32" (999)
40 7/8" (1038)
37 3/4" (958)
36 1/2" (914)
43 1 1/32" (1101)
44 7/8" (1140)
41 3/4" (1060)
40 (1016)
45 1 1/32" (1152)
46 7/8" (1191)
43 3/4" (1111)
42 (1067)
51 1 1/32" (1304)
52 7/8" (1343)
49 3/4" (1263)
48 1 1/2" (1179)
57 1 1/32" (1457)
58 7/8" (1495)
55 3/4" (1416)
54 (1372)
59 1 1/32" (1507)
60 7/8" (1546)
57 3/4" (1466)
56 (1422)
63 1 1/32" (1609)
64 7/8" (1648)
61 3/4" (1568)
60 (1524)
54 15/32" (1384)

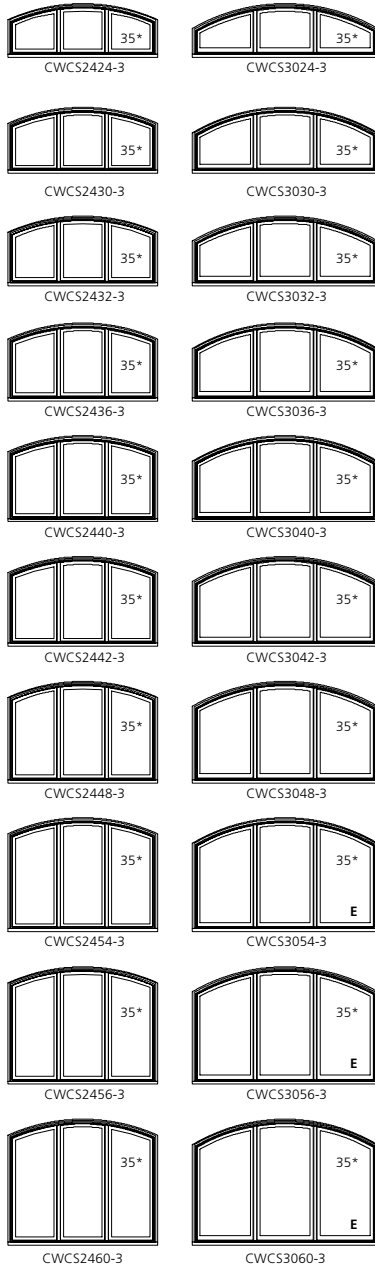

67 11/32" (1711)
68 7/8" (1749)
65 3/4" (1670)
64" (1626)
58 15/32" (1485)
69 1 1/32" (1761)
70 7/8" (1800)
67 3/4" (1720)
66" (1676)
60 15/32" (1536)
75 1 1/32" (1914)
76 7/8" (1953)
73 3/4" (1873)
72" (1829)
66 15/32" (1688)
81 1 1/32" (2066)
82 7/8" (2105)
79 3/4" (2025)
78" (1981)
72 15/32" (1841)
87 1 1/32" (2219)
88 7/8" (2257)
85 3/4" (2178)
84" (2134)
78 15/32" (1993)

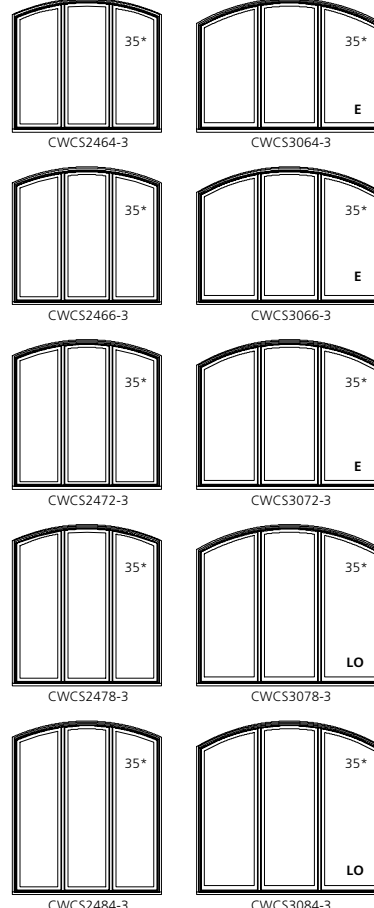

ELEVATION SYMBOL LEGEND:

M.O. = MASONRY OPENING
VALUES IN () ARE IN MILLIMETER CONVERSIONS
VALUES IN [] ARE NUMBER OF DAYLIGHT OPENINGS PER UNIT
E BASIC UNIT CLEAR OPENING EXCEEDS 20" IN WIDTH, 24" IN HEIGHT & A MINIMUM OF 5.7 SQ. FT.
LO LIMITED OPERATION
NUMBER INDICATES DESIGN PRESSURE (DP) RATING WITH STANDARD GLAZING.

Note: Elevations shown DO NOT have exterior trim. Subtract 1/2" (12.7) from M.O. (Masonry Opening) for Unit Sizes. Masonry Openings above include Sill Nose, see Trim Options page for Sill Nose specifications. For other Trim Options refer to the Unit Sizing, Rough Opening & Masonry Openings page.

SCALE: 1/8" = 1'

GENERAL INFORMATION
FRENCH CASEMENTS

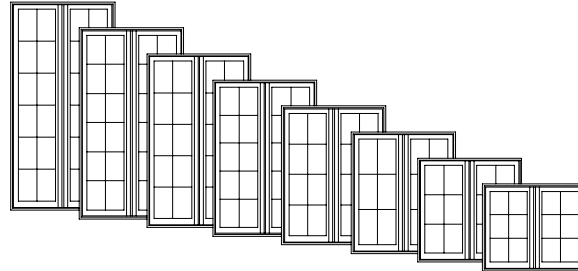

STRAIGHTLINE WINDOWS

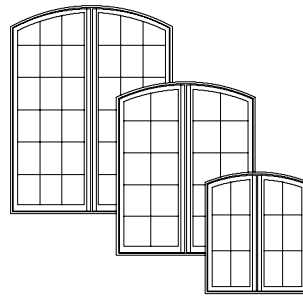

EXTENDED HALF ROUND

French wood casement windows are available as left sash active operation only, or stationary (non-venting). Operating mechanism includes corrosion resistant steel hinges and dual arm roto-type operators with hardened steel gears and operating arms. Sash locking system is a concealed cam and keeper type with an exposed locking lever at the sill operator cover. Refer to the Specifications for hardware finish options.

WOOD FRENCH CASEMENTS utilize some of the same options as WOOD CUSTOM CASEMENTS & WOOD SECTOR TOP CASEMENTS.

HANDING, OPERATION & LIMIT DEVICE
FRENCH CASEMENTS

ILLUSTRATIONS ARE NOT DRAWN TO SCALE

FRENCH CASEMENT HANDING:
FRENCH CASEMENT WINDOWS ARE HANDED WITH THE LEFT SASH AS THE ACTIVE SASH AND THE RIGHT SASH AS THE INACTIVE SASH.

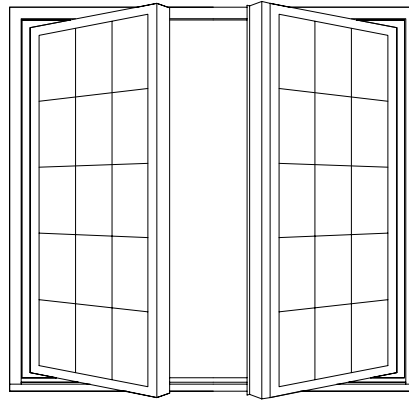

LEFT
ACTIVE

RIGHT
INACTIVE

FRENCH CASEMENT OPERATION:
FRENCH CASEMENT WINDOWS ARE OPERATED WITH THE LEFT SASH OPENED FIRST THEN THE RIGHT SASH OPENED SECOND. TO CLOSE THE WINDOW THE RIGHT SASH IS CLOSED FIRST WITH THE LEFT SASH CLOSING SECOND. THIS OPERATION IS VIEWED FROM THE EXTERIOR.

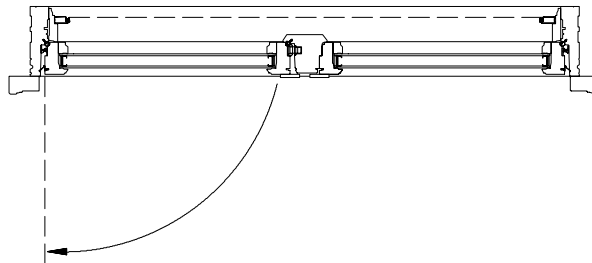

OPENS FIRST
CLOSES SECOND

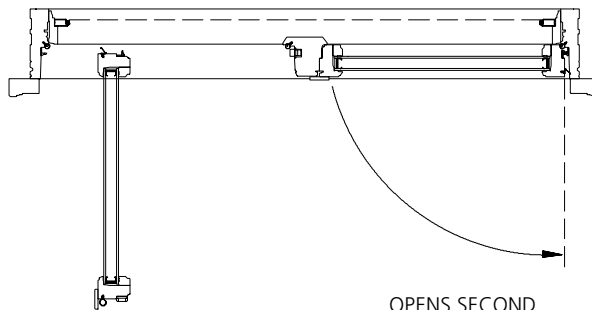

OPENS SECOND
CLOSES FIRST

ELEVATION NOTES
FRENCH CASEMENTS

ELEVATION DRAWINGS UTILIZE A LIMITED NUMBER OF PROJECTED LINES TO PRODUCE A RUDIMENTARY DRAWING INTENDED TO BE USED IN A SMALL GRAPHICAL SCALE. ELEVATIONS ARE VIEWED PERPENDICULAR FROM THE EXTERIOR OF THE STRUCTURE. IF MORE DIMENSIONS ARE NEEDED, USE THE SECTION DRAWINGS FOR MORE COMPLETE DEPICTIONS.

M.O. Brickmould	39 1/4" [997]	Masonry Openings for Brickmould, Flat & Adams Casing. Vertical measurements include subsill. (Subtract 1/2" from Masonry Opening for Unit Size)
M.O. Adams/Flat Casing	42 5/16" [1074]	
Rough Opening	36 3/4" [933]	
Frame Size	36" [914]	
Daylight Opening	13 1/16" [331]	

- 45 5/16" [1151]
- 46 7/8" [1191]
- 43 3/4" [1111]
- 42" [1067]
- 36 15/32" [926]

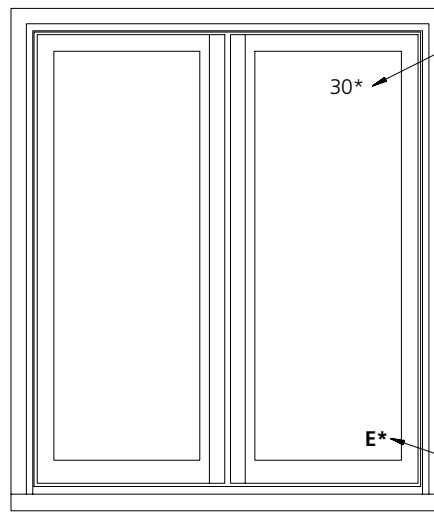

DP RATING
SEE LEGEND BELOW

SEE SYMBOL
LEGEND BELOW

CWCFR3642

'CWCFR' INDICATES
CUSTOM WOOD CASEMENT FRENCH

THE FIRST TWO NUMBERS
INDICATE THE UNIT WIDTH

THE LAST TWO NUMBERS INDICATE
THE UNIT HEIGHT

BOOK CODE

GENERAL CASEMENT NOTES

1. UNIT ELEVATIONS ARE SHOWN WITH BRICKMOULD AND SUBSILL.
2. DIMENSIONAL VALUES IN BRACKETS ARE MILLIMETER CONVERSIONS.

ELEVATION SYMBOL LEGEND:

- E** BASIC UNIT CLEAR OPENING EXCEEDS 20" IN WIDTH, 24" IN HEIGHT & A MINIMUM OF 5.7 SQ. FT.
- E*** BASIC UNIT CLEAR OPENING REQUIRES EGRESS HINGES TO EXCEED 20" IN WIDTH, 24" IN HEIGHT & A MINIMUM, OF 5.7 SQ. FT.
- S** STATIONARY UNIT
- LO** LIMITED OPERATION
- ##*** NUMBER INDICATES DESIGN PRESSURE (DP) RATING WITH STANDARD GLAZING.

FRENCH CASEMENT UNITS

M.O. BRICKMOULD
M.O. ADAMS/FLAT CASING
ROUGH OPENING
FRAME SIZE
DAYLIGHT OPENING

39 1/4" (997)
42 5/16" (1075)
36 3/4" (933)
36" (914)
13 1/16" (332)[2]

51 1/4" (1302)
54 5/16" (1380)
48 3/4" (1238)
48" (1219)
19 1/16" (484)[2]

59 1/4" (1505)
62 5/16" (1583)
56 3/4" (1441)
56" (1422)
23 1/16" (586)[2]

21 11/32" (542)
22 7/8" (581)
19 3/4" (501)
18" (457)
12 15/32" (317)

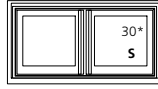

CWCFR3618

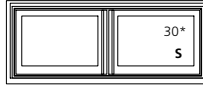

CWCFR4818

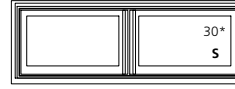

CWCFR5618

23 11/32" (593)
24 7/8" (632)
21 3/4" (552)
20" (508)
14 15/32" (368)

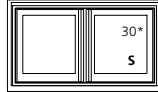

CWCFR3620

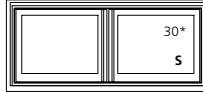

CWCFR4820

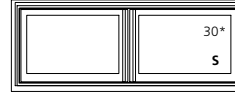

CWCFR5620

27 11/32" (695)
28 7/8" (733)
25 3/4" (654)
24" (610)
18 15/32" (469)

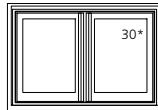

CWCFR3624

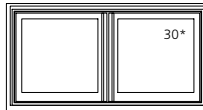

CWCFR4824

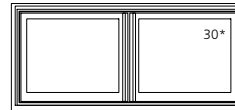

CWCFR5624

33 11/32" (847)
34 7/8" (886)
31 3/4" (806)
30" (762)
24 15/32" (622)

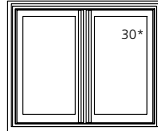

CWCFR3630

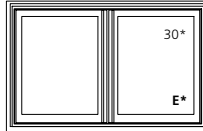

CWCFR4830

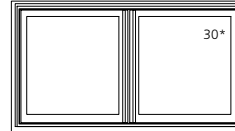

CWCFR5630

35 11/32" (898)
36 7/8" (937)
33 3/4" (857)
32" (813)
26 15/32" (672)

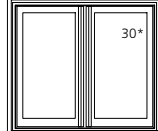

CWCFR3632

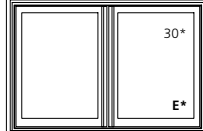

CWCFR4832

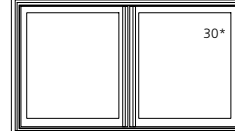

CWCFR5632

39 11/32" (999)
40 7/8" (1038)
37 3/4" (958)
36" (914)
30 15/32" (774)

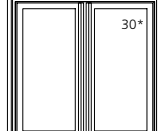

CWCFR3636



CWCFR4836

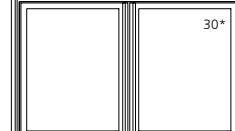

CWCFR5636

43 11/32" (1101)
44 7/8" (1140)
41 3/4" (1060)
40" (1016)
34 15/32" (876)

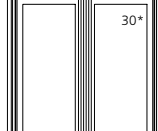

CWCFR3640

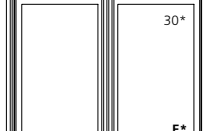

CWCFR4840

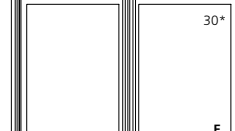

CWCFR5640

45 11/32" (1152)
46 7/8" (1191)
43 3/4" (1111)
42" (1067)
36 15/32" (926)

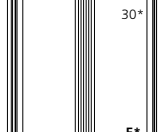

CWCFR3642

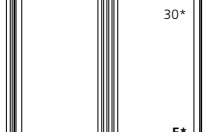

CWCFR4842

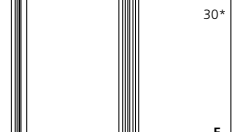

CWCFR5642

ELEVATION SYMBOL LEGEND:

M.O. = MASONRY OPENING

VALUES IN () ARE IN MILLIMETER CONVERSIONS

VALUES IN [] ARE NUMBER OF DAYLIGHT OPENINGS PER UNIT

E BASIC UNIT CLEAR OPENING EXCEEDS 20" IN WIDTH, 24" IN HEIGHT & A MINIMUM OF 5.7 SQ. FT.

E* BASIC UNIT CLEAR OPENING REQUIRES EGRESS HINGES TO EXCEED 20" IN WIDTH, 24" IN HEIGHT & A MINIMUM, OF 5.7 SQ. FT.

S STATIONARY UNIT

##* NUMBER INDICATES DESIGN PRESSURE (DP) RATING WITH STANDARD GLAZING.

Note: Elevations shown DO NOT have exterior trim. Subtract 1/2" (12.7) from M.O. (Masonry Opening) for Unit Sizes. Masonry Openings above include Sill Nose, see Trim Options page for Sill Nose specifications. For other Trim Options refer to the Unit Sizing, Rough Opening & Masonry Openings page.

SCALE: 1/4" = 1'

FRENCH CASEMENT UNITS

M.O. BRICKMOULD
M.O. ADAMS/FLAT CASING
ROUGH OPENING
FRAME SIZE
DAYLIGHT OPENING

39 1/4"(997)
42 5/16"(1075)
36 3/4"(933)
36"(914)
13 1/16"(332)[2]

51 1/4"(1302)
54 5/16"(1380)
48 3/4"(1238)
48"(1219)
19 1/16"(484)[2]

59 1/4"(1505)
62 5/16"(1583)
56 3/4"(1441)
56"(1422)
23 1/16"(586)[2]

51 11/32"(1304)
52 7/8"(1343)
49 3/8"(1259)
42 15/32"(1079)

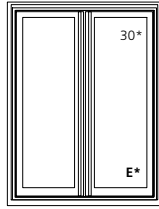

CWCFR3648

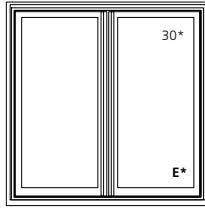

CWCFR4848

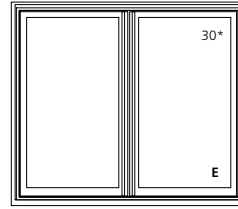

CWCFR5648

57 11/32"(1457)
58 7/8"(1495)
55 3/4"(1372)
48 15/32"(1231)

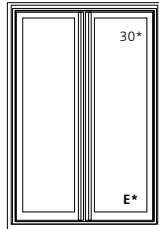

CWCFR3654

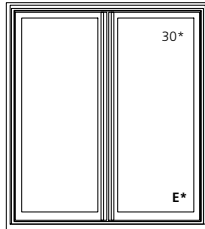

CWCFR4854

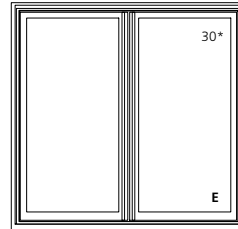

CWCFR5654

59 11/32"(1507)
60 7/8"(1546)
57 3/4"(1423)
50 15/32"(1282)

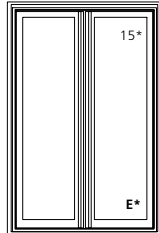

CWCFR3656

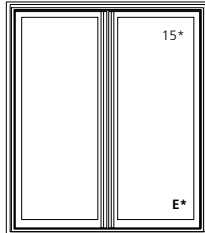

CWCFR4856

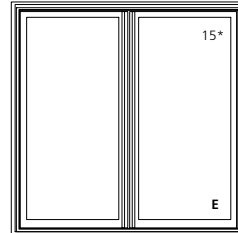

CWCFR5656

63 11/32"(1609)
64 7/8"(1648)
61 3/4"(1525)
54 15/32"(1384)

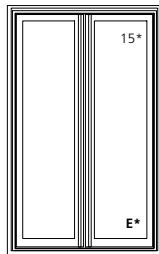

CWCFR3660

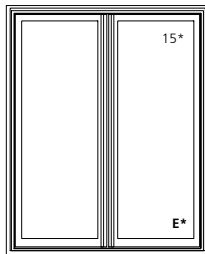

CWCFR4860

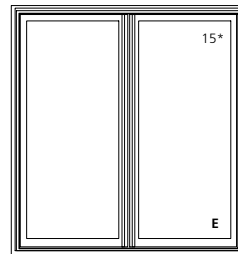

CWCFR5660

67 11/32"(1711)
68 7/8"(1749)
65 3/4"(1626)
58 15/32"(1485)

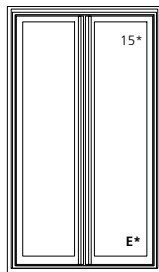

CWCFR3664

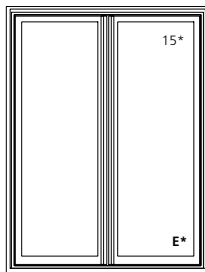

CWCFR4864

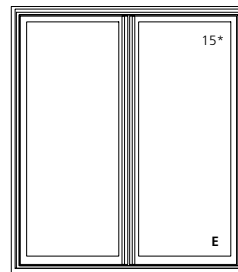

CWCFR5664

ELEVATION SYMBOL LEGEND:

M.O. = MASONRY OPENING

VALUES IN () ARE IN MILLIMETER CONVERSIONS

VALUES IN [] ARE NUMBER OF DAYLIGHT OPENINGS PER UNIT

E BASIC UNIT CLEAR OPENING EXCEEDS 20" IN WIDTH, 24" IN HEIGHT & A MINIMUM OF 5.7 SQ. FT.

E* BASIC UNIT CLEAR OPENING REQUIRES EGRESS HINGES TO EXCEED 20" IN WIDTH, 24" IN HEIGHT & A MINIMUM, OF 5.7 SQ. FT.

##* NUMBER INDICATES DESIGN PRESSURE (DP) RATING WITH STANDARD GLAZING.

Note: Elevations shown DO NOT have exterior trim. Subtract 1/2" (12.7) from M.O. (Masonry Opening) for Unit Sizes. Masonry Openings above include Sill Nose, see Trim Options page for Sill Nose specifications. For other Trim Options refer to the Unit Sizing, Rough Opening & Masonry Openings page.

SCALE: 1/4" = 1'

FRENCH CASEMENT UNITS

M.O. BRICKMOULD
M.O. ADAMS/FLAT CASING
ROUGH OPENING
FRAME SIZE
DAYLIGHT OPENING

39 1/4"(997)
42 5/16"(1075)
36 3/4"(933)
36"(914)
13 1/16"(332)[2]

51 1/4"(1302)
54 5/16"(1380)
48 3/4"(1238)
48"(1219)
19 1/16"(484)[2]

59 1/4"(1505)
62 5/16"(1583)
56 3/4"(1441)
56"(1422)
23 1/16"(586)[2]

69 11/32"(1761)
70 7/8"(1800)
67 3/4"(1720)
66"(1676)
60 15/32"(1536)

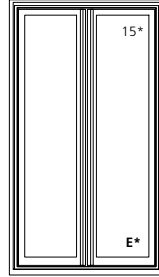

CWCFR3666

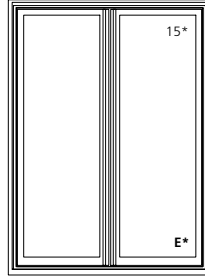

CWCFR4866

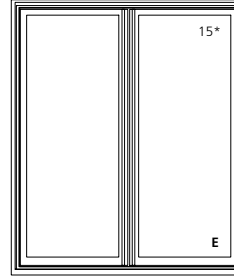

CWCFR5666

75 11/32"(1914)
76 7/8"(1953)
73 3/4"(1873)
72"(1829)
66 15/32"(1688)

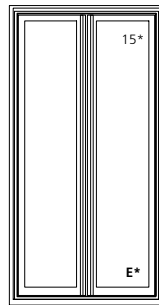

CWCFR3672

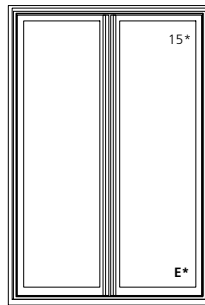

CWCFR4872

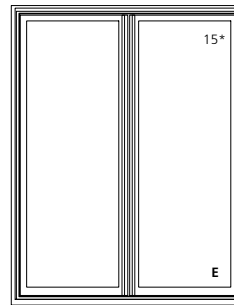

CWCFR5672

ELEVATION SYMBOL LEGEND:

M.O. = MASONRY OPENING
VALUES IN () ARE IN MILLIMETER CONVERSIONS
VALUES IN [] ARE NUMBER OF DAYLIGHT OPENINGS PER UNIT
E BASIC UNIT CLEAR OPENING EXCEEDS 20" IN WIDTH, 24" IN HEIGHT & A MINIMUM OF 5.7 SQ. FT.
E* BASIC UNIT CLEAR OPENING REQUIRES EGRESS HINGES TO EXCEED 20" IN WIDTH, 24" IN HEIGHT & A MINIMUM, OF 5.7 SQ. FT.
##* NUMBER INDICATES DESIGN PRESSURE (DP) RATING WITH STANDARD GLAZING.

Note: Elevations shown DO NOT have exterior trim. Subtract 1/2" (12.7) from M.O. (Masonry Opening) for Unit Sizes. Masonry Openings above include Sill Nose, see Trim Options page for Sill Nose specifications. For other Trim Options refer to the Unit Sizing, Rough Opening & Masonry Openings page.

SCALE: 1/4" = 1'

FRENCH SECTOR TOP CASEMENT UNITS

M.O. BRICKMOULD
M.O. ADAMS/FLAT CASING
ROUGH OPENING
FRAME SIZE
DAYLIGHT OPENING

39 1/4" (997)
42 5/16" (1075)
36 3/4" (933)
36" (914)
13 1/16" (332)[2]

51 1/4" (1302)
54 5/16" (1380)
48 3/4" (1238)
48" (1219)
19 1/16" (484)[2]

59 1/4" (1505)
62 5/16" (1583)
56 3/4" (1441)
56" (1422)
23 1/16" (586)[2]

33 1 1/2" (847)
34 7/8" (886)
34 1/2" (862)
24 15/32" (622)

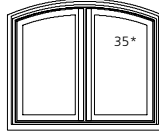

CWCF53630

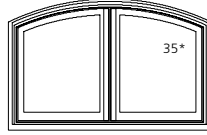

CWCF54830

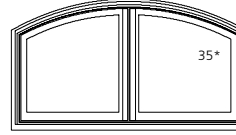

CWCF55630

35 1 1/2" (898)
36 7/8" (937)
36 1/2" (913)
26 15/32" (672)

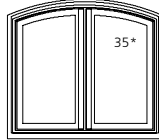

CWCF53632

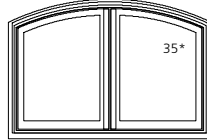

CWCF54832

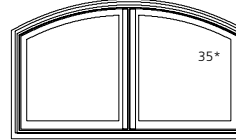

CWCF55632

39 1 1/2" (999)
40 7/8" (1038)
40 1/2" (1014)
30 15/32" (774)

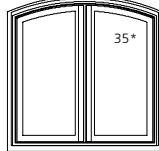

CWCF53636

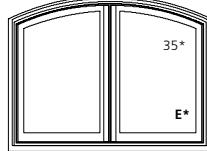

CWCF54836

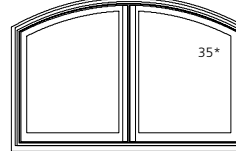

CWCF55636

43 1 1/2" (1101)
44 7/8" (1140)
44 1/2" (1116)
34 15/32" (876)

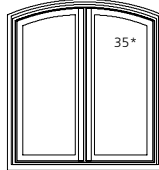

CWCF53640

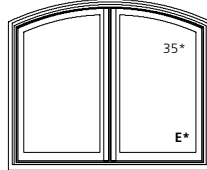

CWCF54840

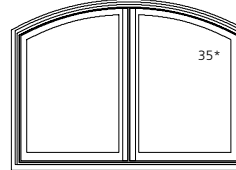

CWCF55640

45 1 1/2" (1152)
46 7/8" (1191)
46 1/2" (1167)
36 15/32" (926)

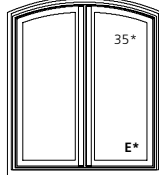

CWCF53642

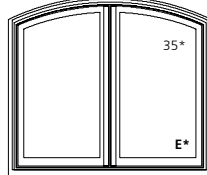

CWCF54842

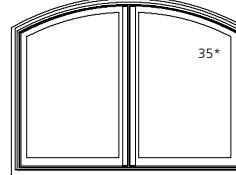

CWCF55642

51 1 1/2" (1304)
52 7/8" (1343)
52 1/2" (1319)
42 15/32" (1079)

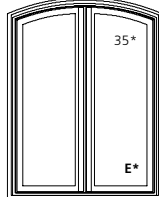

CWCF53648

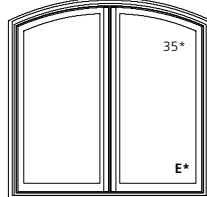

CWCF54848

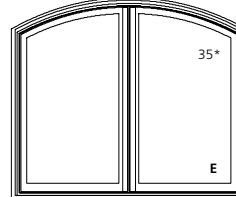

CWCF55648

57 1 1/2" (1457)
58 7/8" (1496)
58 1/2" (1472)
48 15/32" (1231)

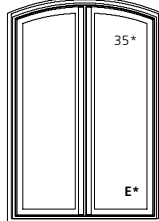

CWCF53654

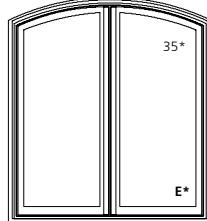

CWCF54854

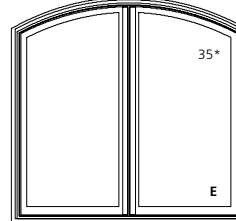

CWCF55654

ELEVATION SYMBOL LEGEND:

M.O. = MASONRY OPENING
VALUES IN () ARE IN MILLIMETER CONVERSIONS
VALUES IN [] ARE NUMBER OF DAYLIGHT OPENINGS PER UNIT
E BASIC UNIT CLEAR OPENING EXCEEDS 20" IN WIDTH, 24" IN HEIGHT & A MINIMUM OF 5.7 SQ. FT.
E* BASIC UNIT CLEAR OPENING REQUIRES EGRESS HINGES TO EXCEED 20" IN WIDTH, 24" IN HEIGHT & A MINIMUM, OF 5.7 SQ. FT.
##* NUMBER INDICATES DESIGN PRESSURE (DP) RATING WITH STANDARD GLAZING.

Note: Elevations shown DO NOT have exterior trim. Subtract 1/2" (12.7) from M.O. (Masonry Opening) for Unit Sizes. Masonry Openings above include Sill Nose, see Trim Options page for Sill Nose specifications. For other Trim Options refer to the Unit Sizing, Rough Opening & Masonry Openings page.

SCALE: 1/4" = 1'

FRENCH SECTOR TOP CASEMENT UNITS

M.O. BRICKMOULD
M.O. ADAMS/FLAT CASING
ROUGH OPENING
FRAME SIZE
DAYLIGHT OPENING

39 1/4"(997)
42 5/16"(1075)
36 3/4"(933)
36"(914)
13 1/16"(332)[2]

51 1/4"(1302)
54 5/16"(1380)
48 3/4"(1238)
48"(1219)
19 1/16"(484)[2]

59 1/4"(1505)
62 5/16"(1583)
56 3/4"(1441)
56"(1422)
23 1/16"(586)[2]

59 11/32"(1507)
60 7/8"(1546)
57 3/4"(1466)
56"(1422)
50 13/32"(1282)

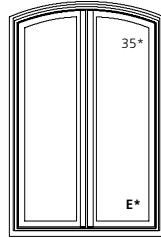

CWCF53656

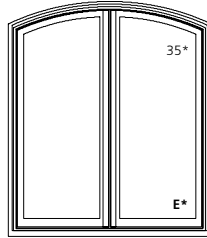

CWCF54856

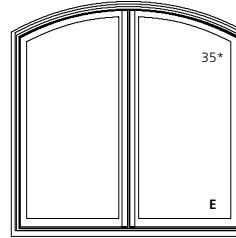

CWCF55656

63 11/32"(1609)
64 7/8"(1648)
61 3/4"(1568)
60"(1520)
54 13/32"(1384)

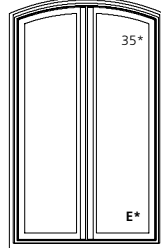

CWCF53660

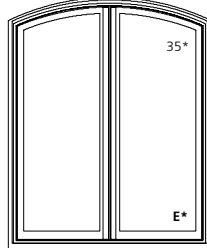

CWCF54860

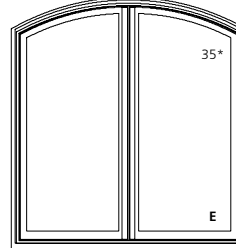

CWCF55660

67 11/32"(1711)
68 7/8"(1749)
65 3/4"(1670)
64"(1620)
58 15/32"(1485)

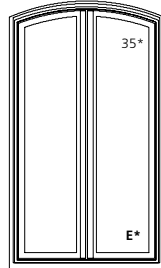

CWCF53664

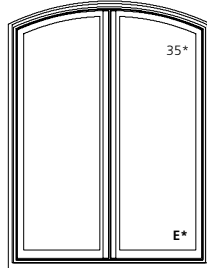

CWCF54864

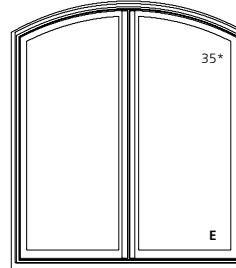

CWCF55664

69 11/32"(1761)
70 7/8"(1800)
67 3/4"(1720)
66"(1670)
60 15/32"(1536)

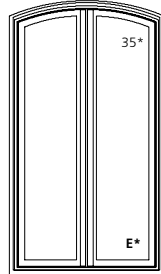

CWCF53666

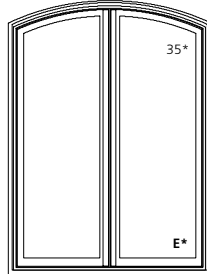

CWCF54866

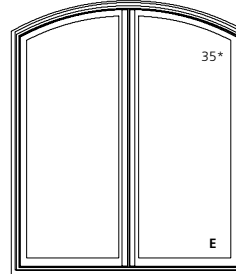

CWCF55666

75 11/32"(1914)
76 7/8"(1953)
73 3/4"(1873)
72"(1825)
66 15/32"(1688)

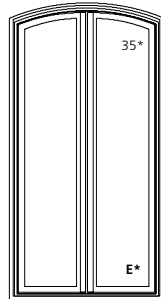

CWCF53672

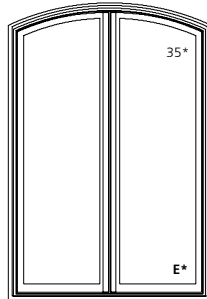

CWCF54872

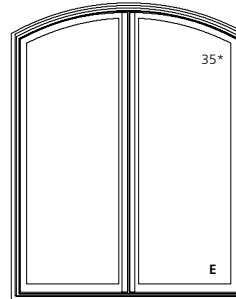

CWCF55672

ELEVATION SYMBOL LEGEND:

M.O. = MASONRY OPENING

VALUES IN () ARE IN MILLIMETER CONVERSIONS

VALUES IN [] ARE NUMBER OF DAYLIGHT OPENINGS PER UNIT

E BASIC UNIT CLEAR OPENING EXCEEDS 20" IN WIDTH, 24" IN HEIGHT & A MINIMUM OF 5.7 SQ. FT.

E* BASIC UNIT CLEAR OPENING REQUIRES EGRESS HINGES TO EXCEED 20" IN WIDTH, 24" IN HEIGHT & A MINIMUM, OF 5.7 SQ. FT.

##* NUMBER INDICATES DESIGN PRESSURE (DP) RATING WITH STANDARD GLAZING.

Note: Elevations shown DO NOT have exterior trim. Subtract 1/2" (12.7) from M.O. (Masonry Opening) for Unit Sizes. Masonry Openings above include Sill Nose, see Trim Options page for Sill Nose specifications. For other Trim Options refer to the Unit Sizing, Rough Opening & Masonry Openings page.

SCALE: 1/4" = 1'

FRENCH HALF-ROUND CASEMENT UNITS

M.O. BRICKMOULD 39 1/4"(997)
M.O. ADAMS/FLAT CASING 42 5/16"(1075)
ROUGH OPENING 36 3/4"(933)
FRAME SIZE 36"(914)
DAYLIGHT OPENING 13 1/16"[2](332)[2]

51 1/4"(1302)
54 5/16"(1380)
48 3/4"(1238)
48"(1219)
19 1/16"[2](484)[2]

M.O. BRICKMOULD 39 1/4"(997)
M.O. ADAMS/FLAT CASING 42 5/16"(1075)
ROUGH OPENING 36 3/4"(933)
FRAME SIZE 36"(914)
DAYLIGHT OPENING 13 1/16"[2](332)[2]

51 1/4"(1302)
54 5/16"(1380)
48 3/4"(1238)
48"(1219)
19 1/16"[2](484)[2]

57 11/32"(1457)
56 7/8"(1495)
55 3/4"(1416)
54 1/2"(1373)
48 15/32"(1231)

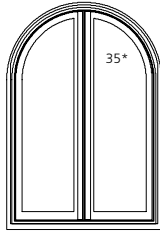

CWCFH3654

59 11/32"(1507)
60 7/8"(1546)
59 3/4"(1466)
58 1/2"(1423)
50 15/32"(1282)

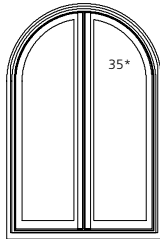

CWCFH3656

63 11/32"(1609)
64 7/8"(1648)
61 3/4"(1568)
60 1/2"(1525)
54 15/32"(1384)

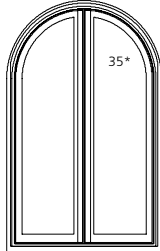

CWCFH3660

67 11/32"(1711)
68 7/8"(1749)
65 3/4"(1670)
64 1/2"(1626)
58 15/32"(1485)

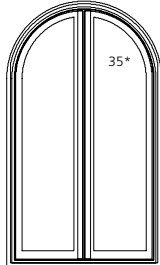

CWCFH3664

69 11/32"(1761)
70 7/8"(1800)
67 3/4"(1720)
66 1/2"(1676)
60 15/32"(1536)

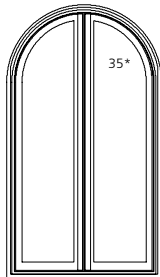

CWCFH3666

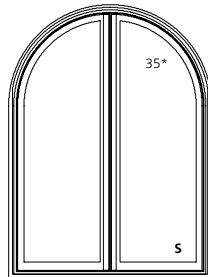

CWCFH4866

75 11/32"(1914)
76 7/8"(1953)
73 3/4"(1873)
72"(1829)
66 15/32"(1688)

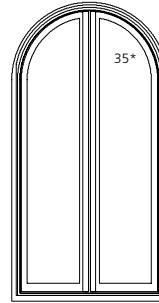

CWCFH3672

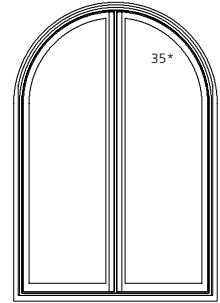

CWCFH4872

ELEVATION SYMBOL LEGEND:
M.O. = MASONRY OPENING
VALUES IN () ARE IN MILLIMETER CONVERSIONS
VALUES IN [] ARE NUMBER OF DAYLIGHT OPENINGS PER UNIT
S STATIONARY UNIT
##* NUMBER INDICATES DESIGN PRESSURE (DP) RATING WITH STANDARD GLAZING.

Note: Elevations shown DO NOT have exterior trim. Subtract 1/2" (12.7) from M.O. (Masonry Opening) for Unit Sizes. Masonry Openings above include Sill Nose, see Trim Options page for Sill Nose specifications. For other Trim Options refer to the Unit Sizing, Rough Opening & Masonry Openings page.

SCALE: 1/4" = 1'

EXTENDED HALF-ROUND UNITS

M.O. BRICKMOULD
M.O. ADAMS/FLAT CASING
ROUGH OPENING
FRAME SIZE
DAYLIGHT OPENING

21 1/4" (540)	23 1/4" (591)	27 1/4" (692)	31 1/4" (794)	33 1/4" (845)
24 5/16" (618)	26 5/16" (668)	30 5/16" (770)	34 5/16" (872)	36 5/16" (922)
18 3/4" (476)	20 3/4" (527)	24 3/4" (629)	28 3/4" (730)	30 3/4" (781)
18" (457)	20" (508)	24" (610)	28" (711)	30" (762)
13 1/16" (332)	15 1/16" (383)	19 1/16" (484)	23 1/16" (586)	25 1/16" (637)

27 11/32" (695)
28 7/8" (733)
25 3/4" (654)
24" (610)
18 15/32" (469)



CWCH1824 CWCH2024 CWCH2424

33 11/32" (847)
34 7/8" (886)
31 3/4" (806)
30" (762)
24 15/32" (622)

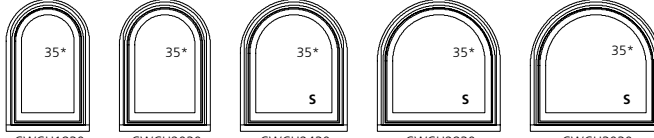

CWCH1830 CWCH2030 CWCH2430 CWCH2830 CWCH3030

35 11/32" (898)
36 7/8" (937)
33 3/4" (857)
32" (813)
26 15/32" (672)

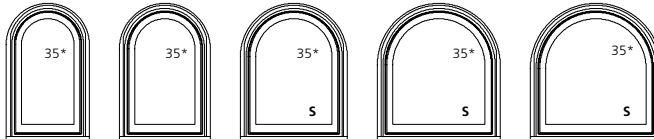

CWCH1832 CWCH2032 CWCH2432 CWCH2832 CWCH3032

39 11/32" (999)
40 7/8" (1038)
37 3/4" (958)
36" (914)
30 15/32" (774)

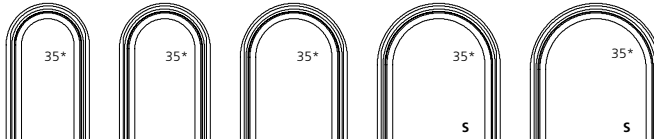

CWCH1836 CWCH2036 CWCH2436 CWCH2836 CWCH3036

43 11/32" (1101)
44 7/8" (1140)
41 3/4" (1060)
40" (1016)
34 15/32" (876)

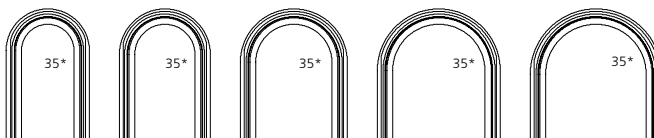

CWCH1840 CWCH2040 CWCH2440 CWCH2840 CWCH3040

45 11/32" (1152)
46 7/8" (1191)
43 3/4" (1111)
42" (1067)
36 15/32" (926)

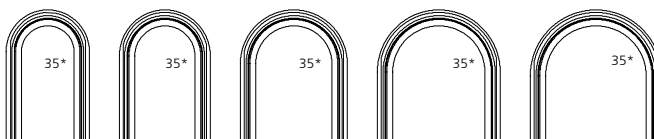

CWCH1842 CWCH2042 CWCH2442 CWCH2842 CWCH3042

51 11/32" (1304)
52 7/8" (1343)
49 3/4" (1263)
48" (1219)
42 15/32" (1079)

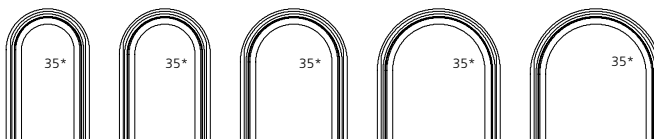

CWCH1848 CWCH2048 CWCH2448 CWCH2848 CWCH3048

ELEVATION SYMBOL LEGEND:
M.O. = MASONRY OPENING
VALUES IN () ARE IN MILLIMETER CONVERSIONS
S = STATIONARY UNIT
##* = NUMBER INDICATES DESIGN PRESSURE (DP) RATING WITH STANDARD GLAZING.

Note: Elevations shown DO NOT have exterior trim. Subtract 1/2" (12.7) from M.O. (Masonry Opening) for Unit Sizes. Masonry Openings above include Sill Nose, see Trim Options page for Sill Nose specifications. For other Trim Options refer to the Unit Sizing, Rough Opening & Masonry Openings page.

SCALE: 1/4" = 1'

EXTENDED HALF-ROUND UNITS

M.O. BRICKMOULD
M.O. ADAMS/FLAT CASING
ROUGH OPENING
FRAME SIZE
DAYLIGHT OPENING

21 1/4" (540)	23 1/4" (591)	27 1/4" (692)	31 1/4" (794)	33 1/4" (845)
24 5/16" (618)	26 5/16" (668)	30 5/16" (770)	34 5/16" (872)	36 5/16" (922)
18 3/4" (476)	20 3/4" (527)	24 3/4" (629)	28 3/4" (730)	30 3/4" (781)
18" (457)	20" (508)	24" (610)	28" (711)	30" (762)
13 1/16" (332)	15 1/16" (383)	19 1/16" (484)	23 1/16" (586)	25 1/16" (637)

57 11/32" (1457)
58 7/8" (1495)
55 3/4" (1416)
54" (1372)
48 15/32" (1231)

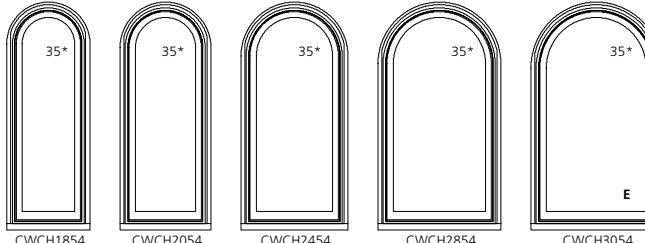

59 11/32" (1507)
60 7/8" (1546)
57 3/4" (1466)
56" (1422)
50 15/32" (1282)

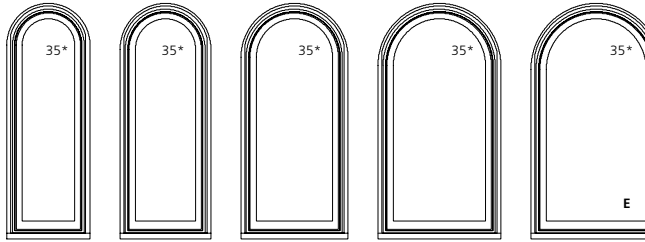

63 11/32" (1609)
64 7/8" (1648)
61 3/4" (1568)
60" (1524)
54 15/32" (1384)

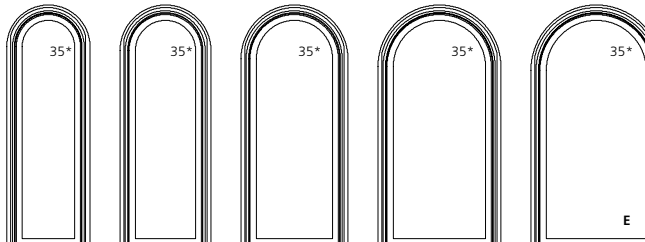

67 11/32" (1711)
68 7/8" (1749)
65 3/4" (1670)
64" (1626)
58 15/32" (1485)

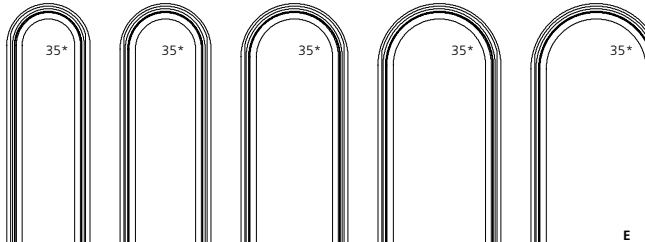

69 11/32" (1761)
70 7/8" (1800)
67 3/4" (1720)
66" (1676)
60 15/32" (1536)

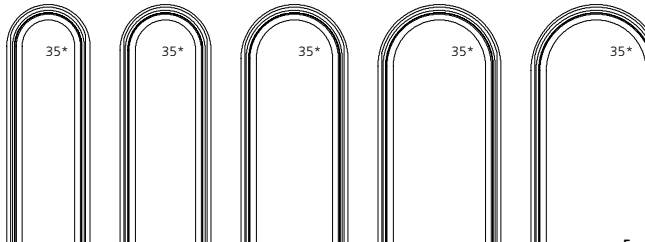

ELEVATION SYMBOL LEGEND:

M.O. = MASONRY OPENING
VALUES IN () ARE IN MILLIMETER CONVERSIONS
E BASIC UNIT CLEAR OPENING EXCEEDS 20" IN WIDTH, 24" IN HEIGHT & A MINIMUM OF 5.7 SQ. FT.
##* NUMBER INDICATES DESIGN PRESSURE (DP) RATING WITH STANDARD GLAZING.

Note: Elevations shown DO NOT have exterior trim. Subtract 1/2" (12.7) from M.O. (Masonry Opening) for Unit Sizes. Masonry Openings above include Sill Nose, see Trim Options page for Sill Nose specifications. For other Trim Options refer to the Unit Sizing, Rough Opening & Masonry Openings page.

SCALE: 1/4" = 1'

EXTENDED HALF-ROUND UNITS

**M.O. BRICKMOUND
M.O. ADAMS/FLAT CASING
ROUGH OPENING
FRAME SIZE
DAYLIGHT OPENING**

21 1/4" (540)	23 1/4" (591)	27 1/4" (692)	31 1/4" (794)	33 1/4" (845)
24 5/16" (618)	26 5/16" (668)	30 5/16" (770)	34 5/16" (872)	36 5/16" (922)
18 3/4" (476)	20 3/4" (527)	24 3/4" (629)	28 3/4" (730)	30 3/4" (781)
18" (457)	20" (508)	24" (610)	28" (711)	30" (762)
13 1/16" (332)	15 1/16" (383)	19 1/16" (484)	23 1/16" (586)	25 1/16" (637)

75 11/32" (1914)
76 7/8" (1953)
73 3/4" (1873)
72" (1829)
66 15/32" (1688)

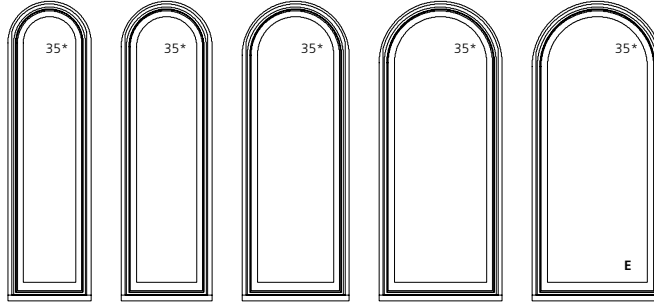

81 11/32" (2066)
82 7/8" (2105)
79 3/4" (2025)
78" (1981)
72 15/32" (1841)

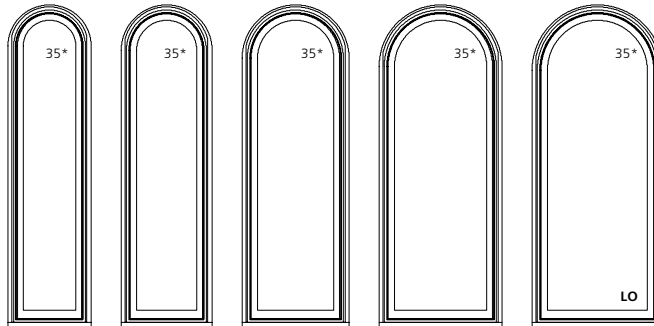

87 11/32" (2219)
88 7/8" (2257)
85 3/4" (2178)
84" (2134)
78 15/32" (1993)

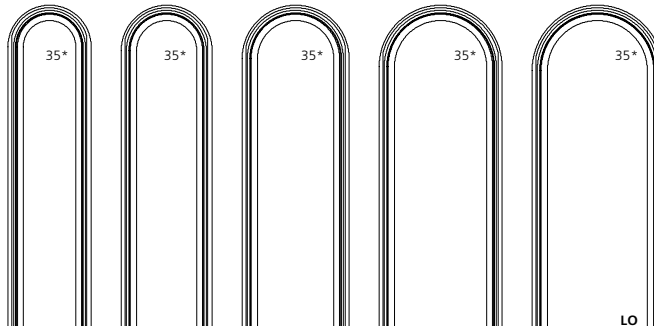

ELEVATION SYMBOL LEGEND:

M.O. = MASONRY OPENING
VALUES IN () ARE IN MILLIMETER CONVERSIONS
E BASIC UNIT CLEAR OPENING EXCEEDS 20" IN WIDTH, 24" IN HEIGHT & A MINIMUM OF 5.7 SQ. FT.
LO LIMITED OPERATION
##* NUMBER INDICATES DESIGN PRESSURE (DP) RATING WITH STANDARD GLAZING.

Note: Elevations shown DO NOT have exterior trim. Subtract 1/2" (12.7) from M.O. (Masonry Opening) for Unit Sizes. Masonry Openings above include Sill Nose, see Trim Options page for Sill Nose specifications. For other Trim Options refer to the Unit Sizing, Rough Opening & Masonry Openings page.

SCALE: 1/4" = 1'

EXTENDED QUARTER ROUND UNITS

M.O. BRICKMOULD
M.O. ADAMS/FLAT CASING
ROUGH OPENING
FRAME SIZE
DAYLIGHT OPENING

21 1/4" (540)
24 5/16" (618)
18 3/4" (476)
18" (457)
13 1/16" (332)

23 1/4" (591)
26 5/16" (668)
20 3/4" (527)
20" (508)
15 1/16" (383)

27 1/4" (692)
30 5/16" (770)
24 3/4" (629)
24" (610)
19 1/16" (484)

31 1/4" (794)
34 5/16" (872)
28 3/4" (730)
28" (586)
23 1/16" (586)

33 1/4" (845)
36 5/16" (922)
30 3/4" (781)
30" (762)
25 1/16" (637)

33 11/32" (847)
34 7/8" (886)
31 3/4" (806)
30" (762)
24 15/32" (622)



CWCQ1830



CWCQ2030



CWCQ2430

35 11/32" (898)
36 7/8" (937)
33 3/4" (857)
32" (813)
26 15/32" (672)



CWCQ1832



CWCQ2032

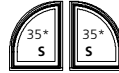

CWCQ2432

39 11/32" (999)
40 7/8" (1038)
37 3/4" (958)
36" (914)
30 15/32" (774)



CWCQ1836



CWCQ2036



CWCQ2436



CWCQ2836



CWCQ3036

43 11/32" (1101)
44 7/8" (1140)
41 3/4" (1060)
40" (1016)
34 15/32" (876)



CWCQ1840



CWCQ2040



CWCQ2440

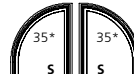

CWCQ2840



CWCQ3040

45 11/32" (1152)
46 7/8" (1191)
43 3/4" (1111)
42" (1067)
36 15/32" (926)



CWCQ1842



CWCQ2042



CWCQ2442



CWCQ2842

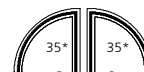

CWCQ3042

51 11/32" (1304)
52 7/8" (1343)
49 3/4" (1263)
48" (1219)
42 15/32" (1079)



CWCQ1848

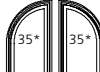

CWCQ2048

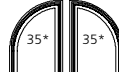

CWCQ2448

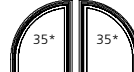

CWCQ2848

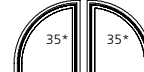

CWCQ3048

57 11/32" (1457)
58 7/8" (1495)
55 3/4" (1416)
54" (1372)
48 15/32" (1231)



CWCQ1854

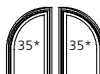

CWCQ2054

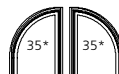

CWCQ2454

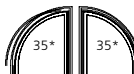

CWCQ2854

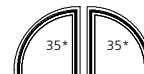

CWCQ3054

59 11/32" (1507)
60 7/8" (1546)
57 3/4" (1466)
56" (1422)
50 15/32" (1282)



CWCQ1856



CWCQ2056



CWCQ2456



CWCQ2856

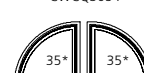

CWCQ3056

63 11/32" (1609)
64 7/8" (1648)
61 3/4" (1568)
60" (1524)
54 15/32" (1384)



CWCQ1860



CWCQ2060



CWCQ2460



CWCQ2860



CWCQ3060

67 11/32" (1711)
68 7/8" (1749)
65 3/4" (1670)
64" (1626)
58 15/32" (1485)



CWCQ1864



CWCQ2064



CWCQ2464



CWCQ2864



CWCQ3064

ELEVATION SYMBOL LEGEND:

M.O. = MASONRY OPENING

VALUES IN () ARE IN MILLIMETER CONVERSIONS

S STATIONARY UNIT

NUMBER INDICATES DESIGN PRESSURE (DP) RATING WITH STANDARD GLAZING.

Note: Elevations shown DO NOT have exterior trim. Subtract 1/2" (12.7) from M.O. (Masonry Opening) for Unit Sizes. Masonry Openings above include Sill Nose, see Trim Options page for Sill Nose specifications. For other Trim Options refer to the Unit Sizing, Rough Opening & Masonry Openings page.

SCALE: 1/8" = 1'

EXTENDED QUARTER ROUND UNITS

M.O. BRICKMOULD M.O. ADAMS/FLAT CASING ROUGH OPENING FRAME SIZE DAYLIGHT OPENING	21 1/4"(540) 24 5/16"(618) 18 3/4"(476) 18"(457) 13 1/16"(332)	23 1/4"(591) 26 5/16"(668) 20 3/4"(527) 20"(508) 15 1/16"(383)	27 1/4"(692) 30 5/16"(770) 24 3/4"(629) 24"(610) 19 1/16"(484)	31 1/4"(794) 34 5/16"(872) 28 3/4"(730) 28"(586) 23 1/16"(586)	33 1/4"(845) 36 5/16"(922) 30 3/4"(781) 30"(762) 25 1/16"(637)
69 11/32"(1761) 70 7/8"(1800) 67 3/4"(1720) 66"(1676) 60 15/32"(1536)					
75 11/32"(1914) 76 7/8"(1953) 73 3/4"(1873) 72"(1829) 66 15/32"(1688)					
81 11/32"(2066) 82 7/8"(2105) 79 3/4"(2025) 78"(1981) 72 15/32"(1841)					
87 11/32"(2219) 88 7/8"(2257) 85 3/4"(2178) 84"(2134) 78 15/32"(1993)					

ELEVATION SYMBOL LEGEND:

M.O. = MASONRY OPENING
VALUES IN () ARE IN MILLIMETER CONVERSIONS

S = STATIONARY UNIT

LO = LIMITED OPERATION

##* = NUMBER INDICATES DESIGN PRESSURE (DP) RATING WITH STANDARD GLAZING.

Note: Elevations shown DO NOT have exterior trim. Subtract 1/2" (12.7) from M.O. (Masonry Opening) for Unit Sizes. Masonry Openings above include Sill Nose, see Trim Options page for Sill Nose specifications. For other Trim Options refer to the Unit Sizing, Rough Opening & Masonry Openings page.

GLAZING OPTIONS
CASEMENT

INTERIOR GLAZED
INSULATED 3/4" [19] GLASS

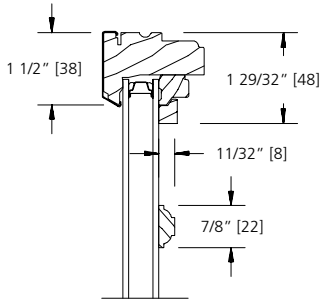

7/8" FULL SURROUND

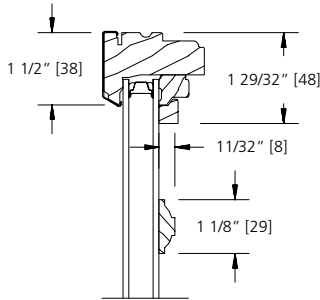

1 1/8" FULL SURROUND

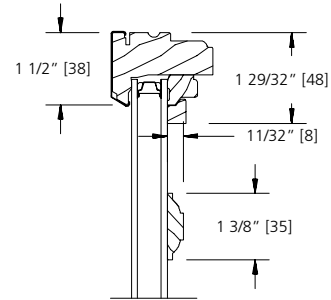

1 3/8" FULL SURROUND

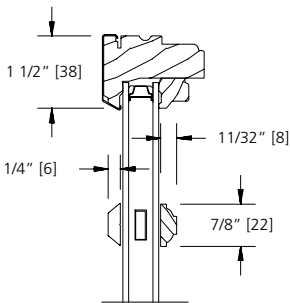

**7/8" SDL BAR
(PUTTY LINE)**

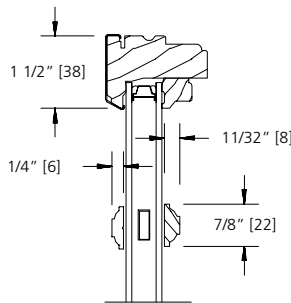

**7/8" SDL BAR
(BEAD STOP)**

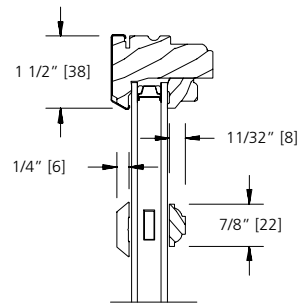

**1 1/8" SDL BAR
(PUTTY LINE)**

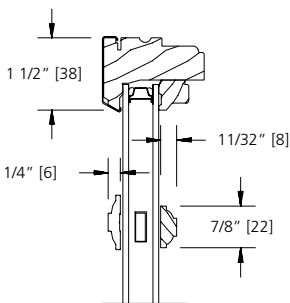

**1 1/8" SDL BAR
(BEAD STOP)**

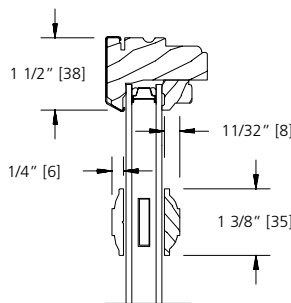

**1 3/8" SDL BAR
(BEAD STOP)**

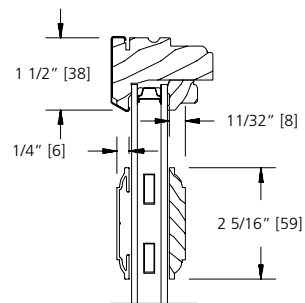

**2 5/16" SDL BAR
(BEAD STOP)**

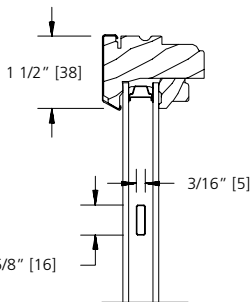

**5/8" FLAT
GBG**

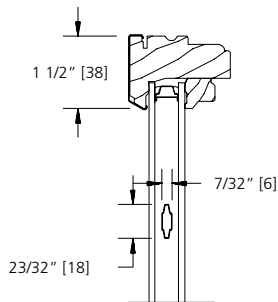

**23/32" CONTOUR
GBG**

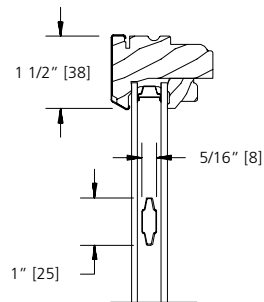

**1" CONTOUR
GBG**

SCALE: 3" = 1'

GLAZING OPTIONS
CASEMENT

INTERIOR GLAZED

SINGLE GLAZED 1/8" [3] GLASS

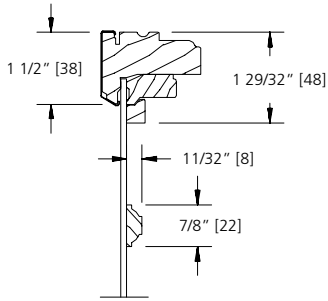

7/8" FULL SURROUND

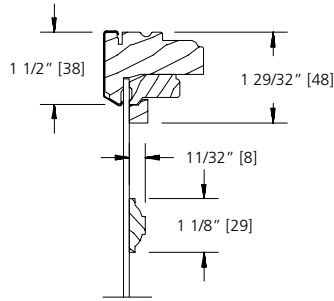

1 1/8" FULL SURROUND

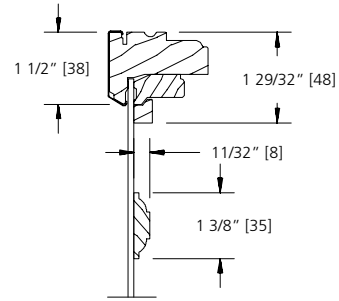

1 3/8" FULL SURROUND

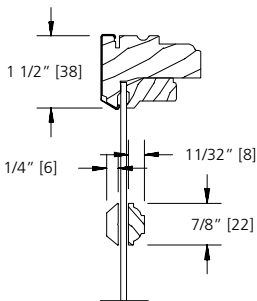

**7/8" SDL
(PUTTY LINE)**

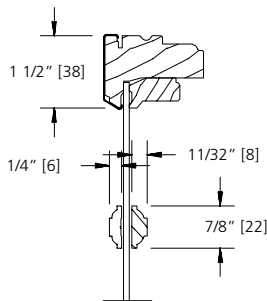

**7/8" SDL
(BEAD STOP)**

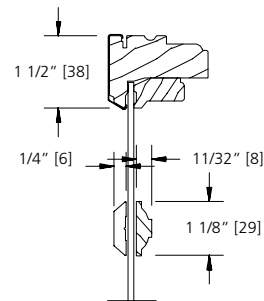

**1 1/8" SDL
(PUTTY LINE)**

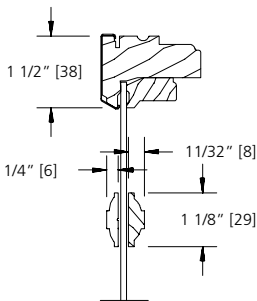

**1 1/8" SDL
(BEAD STOP)**

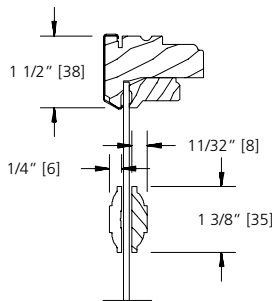

**1 3/8" SDL
(BEAD STOP)**

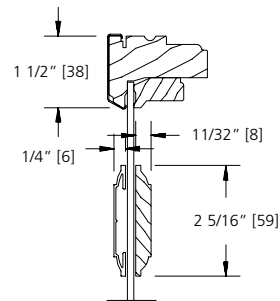

**2 5/16" SDL BAR
(BEAD STOP)**

SCALE: 3" = 1'

GLAZING OPTIONS
CASEMENT

EXTERIOR GLAZED

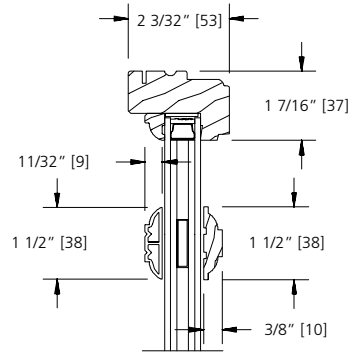

1 1/2" PDL
CLAD EXTERIOR BAR
3/4" [19] Glass

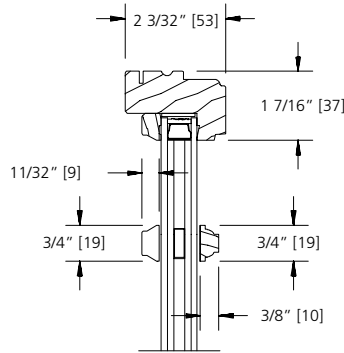

3/4" PDL
CLAD EXTERIOR BAR
3/4" [19] Glass

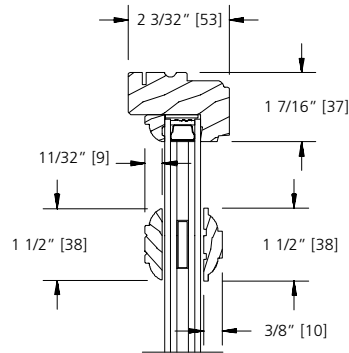

1 1/2" PDL
WOOD EXTERIOR BAR
3/4" [19] Glass

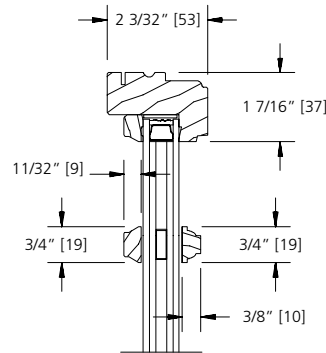

3/4" PDL
WOOD EXTERIOR BAR
3/4" [19] Glass

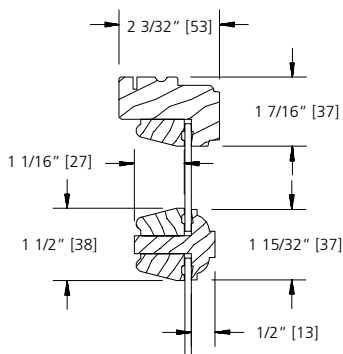

1 1/2" TDL
TRUE DIVIDED LITE
1/8" [3] Glass

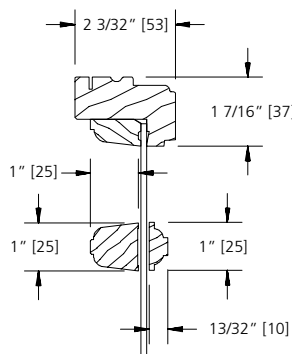

1" PNB
1/8" [3] Glass

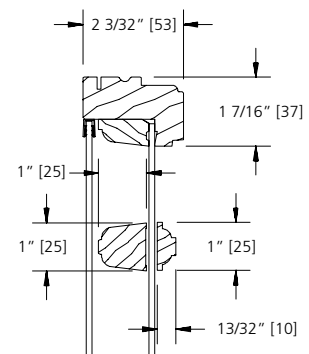

1" PNB
WITH ENERGY PANEL

SCALE: 3" = 1'

GLAZING OPTIONS
SECTOR TOP CASEMENT

INTERIOR GLAZED
INSULATED 15/16" [24] GLASS

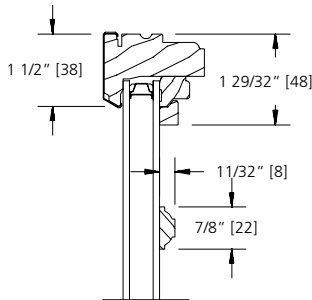

7/8" FULL SURROUND

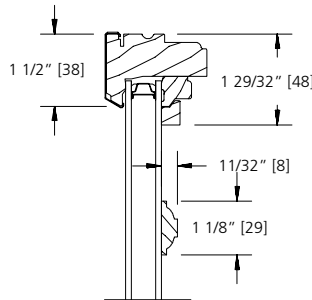

1 1/8" FULL SURROUND

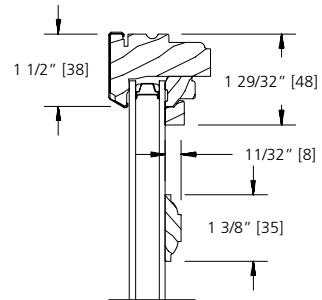

1 3/8" FULL SURROUND

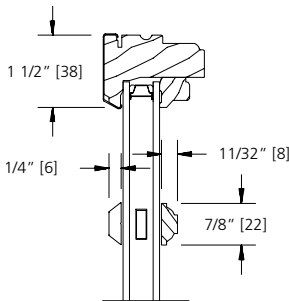

7/8" SDL BAR
(PUTTY LINE)

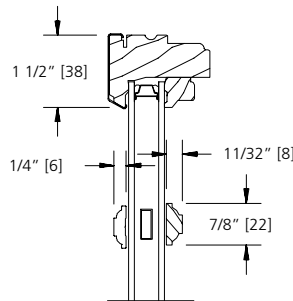

7/8" SDL BAR
(BEAD STOP)

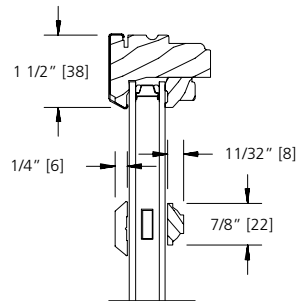

1 1/8" SDL BAR
(PUTTY LINE)

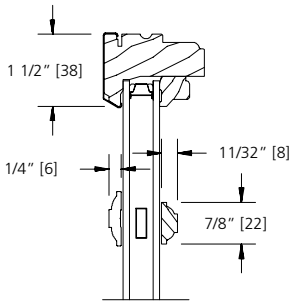

1 1/8" SDL BAR
(BEAD STOP)

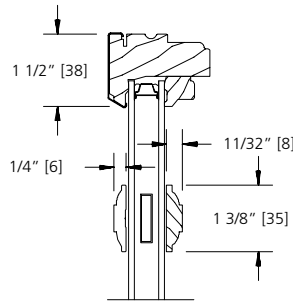

1 3/8" SDL BAR
(BEAD STOP)

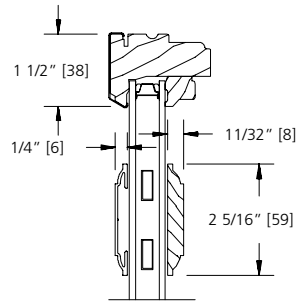

2 5/16" SDL BAR
(BEAD STOP)

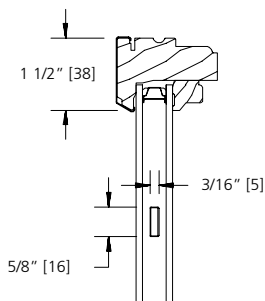

5/8" FLAT
GBG

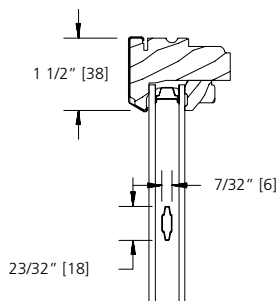

23/32" CONTOUR
GBG

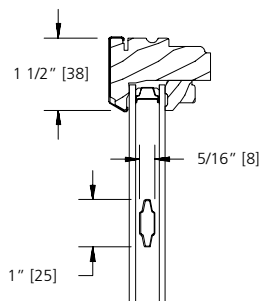

1" CONTOUR
GBG

SCALE: 3" = 1'

GLAZING OPTIONS
SECTOR TOP CASEMENT

INTERIOR GLAZED

SINGLE GLAZED 1/8" [3] GLASS

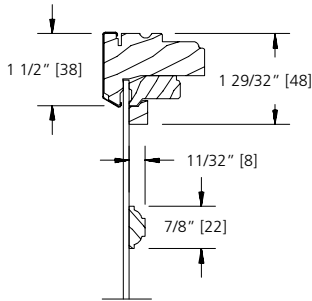

7/8" FULL SURROUND

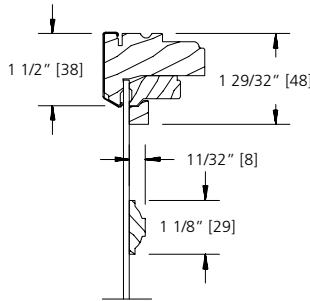

1 1/8" FULL SURROUND

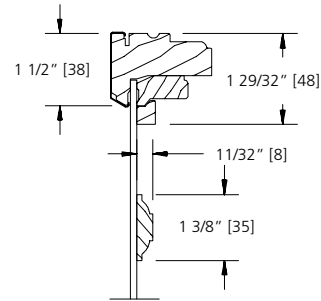

1 3/8" FULL SURROUND

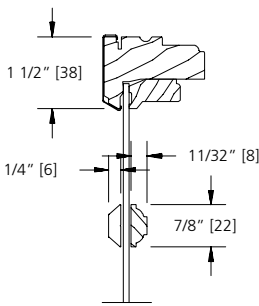

**7/8" SDL
(PUTTY LINE)**

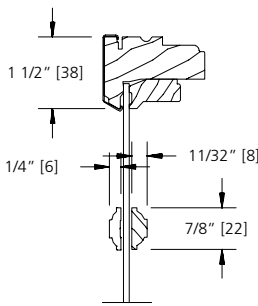

**7/8" SDL
(BEAD STOP)**

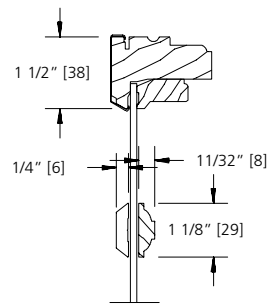

**1 1/8" SDL
(PUTTY LINE)**

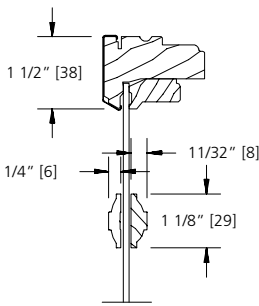

**1 1/8" SDL
(BEAD STOP)**

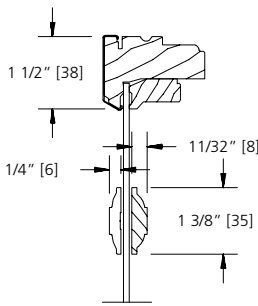

**1 3/8" SDL
(BEAD STOP)**

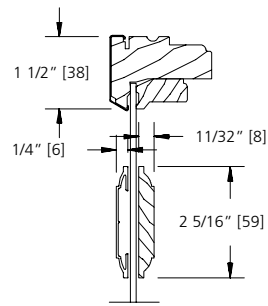

**2 5/16" SDL BAR
(BEAD STOP)**

SCALE: 3" = 1'

GLAZING OPTIONS
SECTOR TOP CASEMENT

INTERIOR GLAZED
IMPACT RESISTANT GLASS

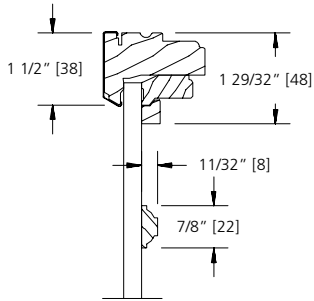

7/8" FULL SURROUND

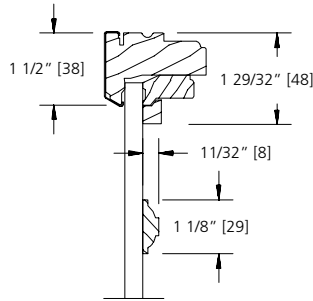

1 1/8" FULL SURROUND

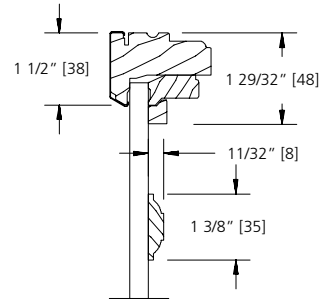

1 3/8" FULL SURROUND

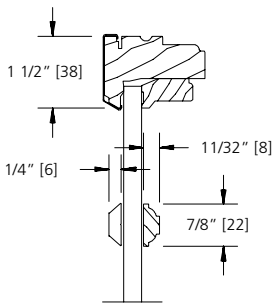

7/8" SDL
(PUTTY LINE)

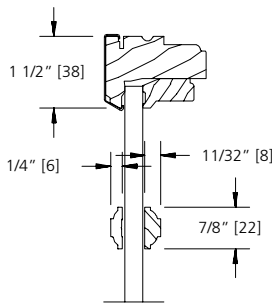

7/8" SDL
(BEAD STOP)

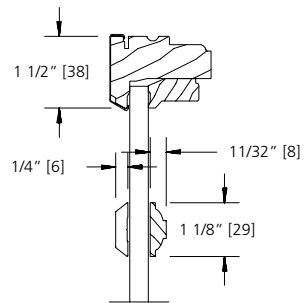

1 1/8" SDL
(PUTTY LINE)

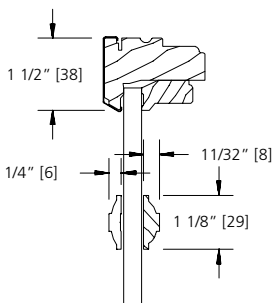

1 1/8" SDL
(BEAD STOP)

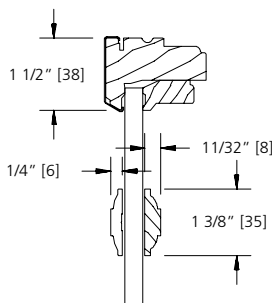

1 3/8" SDL
(BEAD STOP)

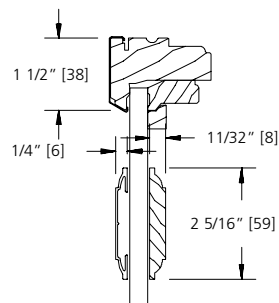

2 5/16" SDL BAR
(BEAD STOP)

SCALE: 3" = 1'

GLAZING OPTIONS
SECTOR TOP CASEMENT

EXTERIOR GLAZED

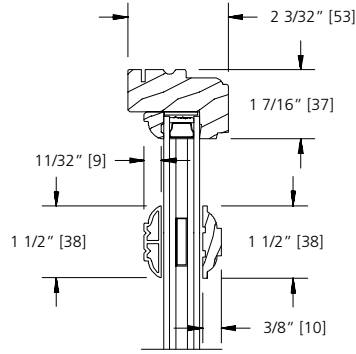

1 1/2" PDL
CLAD EXTERIOR BAR
3/4" [19] Glass

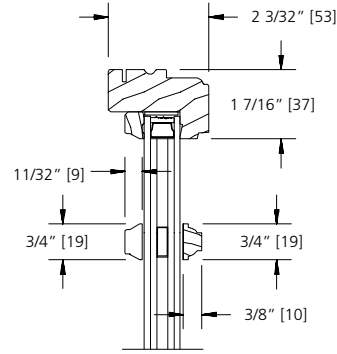

3/4" PDL
CLAD EXTERIOR BAR
3/4" [19] Glass

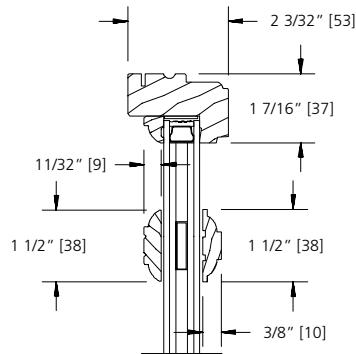

1 1/2" PDL
WOOD EXTERIOR BAR
3/4" [19] Glass

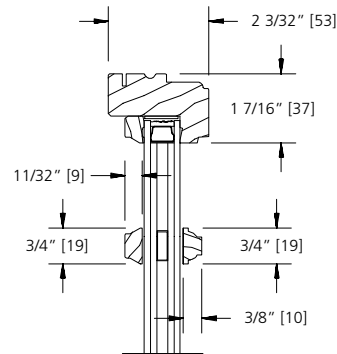

3/4" PDL
WOOD EXTERIOR BAR
3/4" [19] Glass

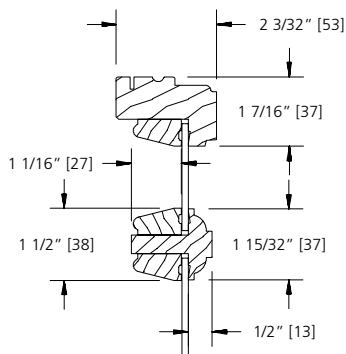

1 1/2" TDL
TRUE DIVIDED LITE
1/8" [3] Glass

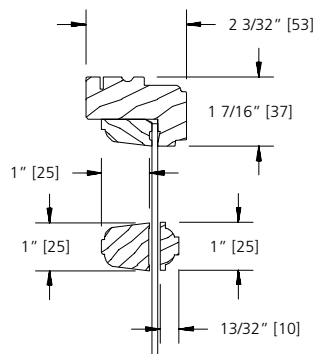

1" PNB
1/8" [3] Glass

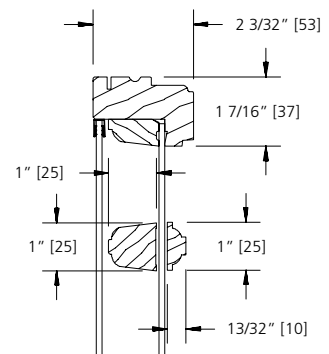

1" PNB
WITH ENERGY PANEL

SCALE: 3" = 1'

**TRIM OPTIONS
CASEMENT**

WOOD EXTERIOR TRIM

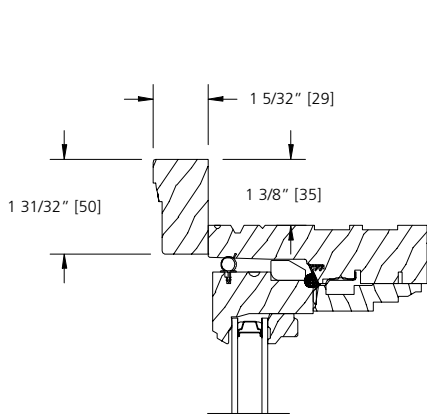

BRICKMOULD

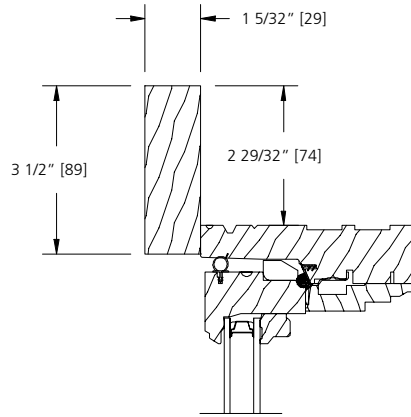

3 1/2\"/>

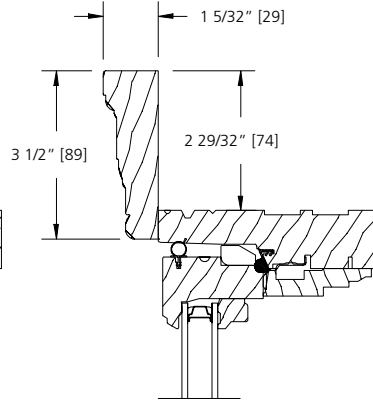

**ADAMS
CASING**

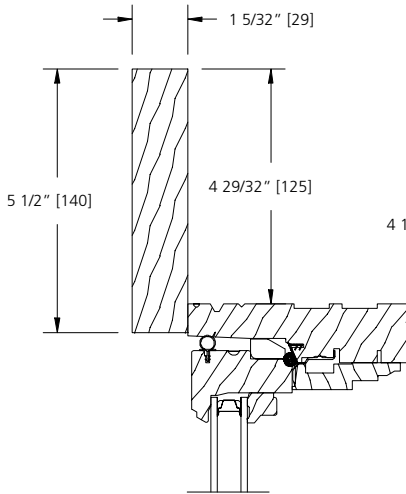

5 1/2\"/>

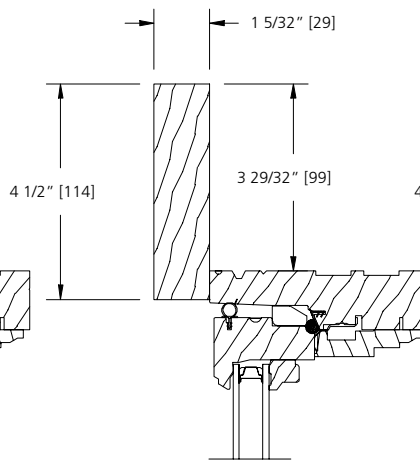

4 1/2\"/>

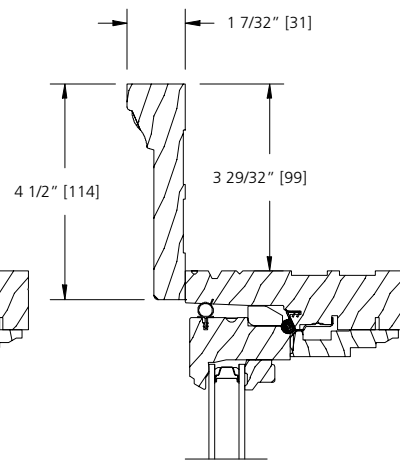

**1 X 4
BACKBAND CASING**

WOOD SUBSILL OPTIONS

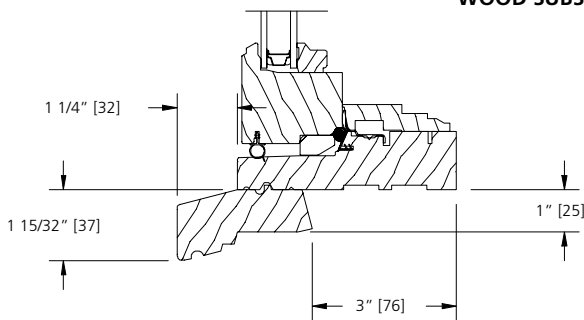

WOOD SUBSILL

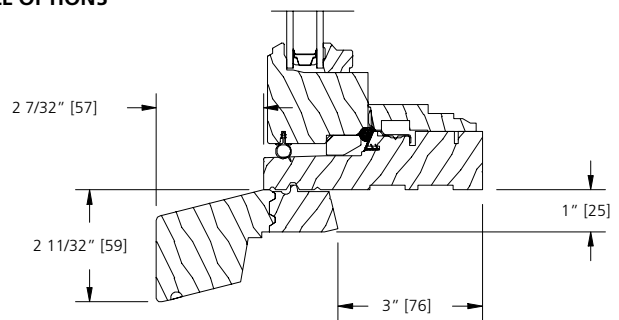

WOOD HISTORICAL SUBSILL

SCALE: 3" = 1'

JAMB EXTENDER & STUCCO TRIM OPTIONS

JAMB EXTENDER OPTIONS

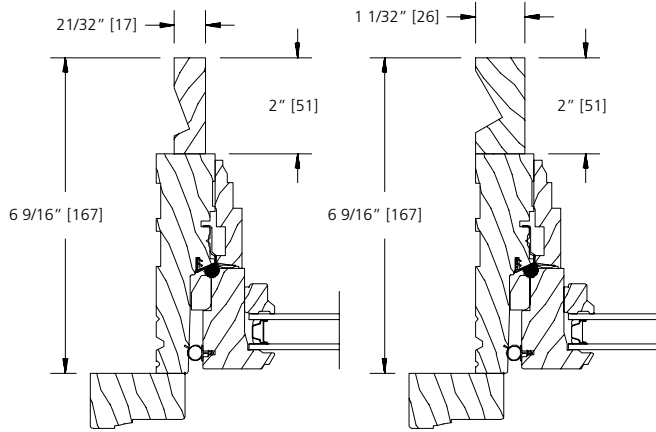

2\"/>

2\"/>

STUCCO TRIM OPTION

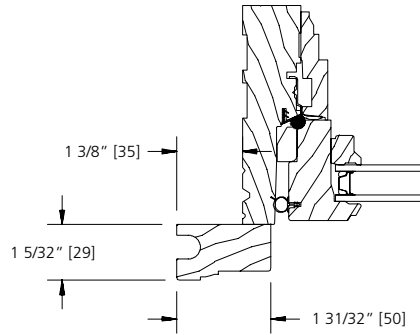

**SIDE
STUCCO BRICKMOULD**

MAXIMUM JAMB WIDTHS

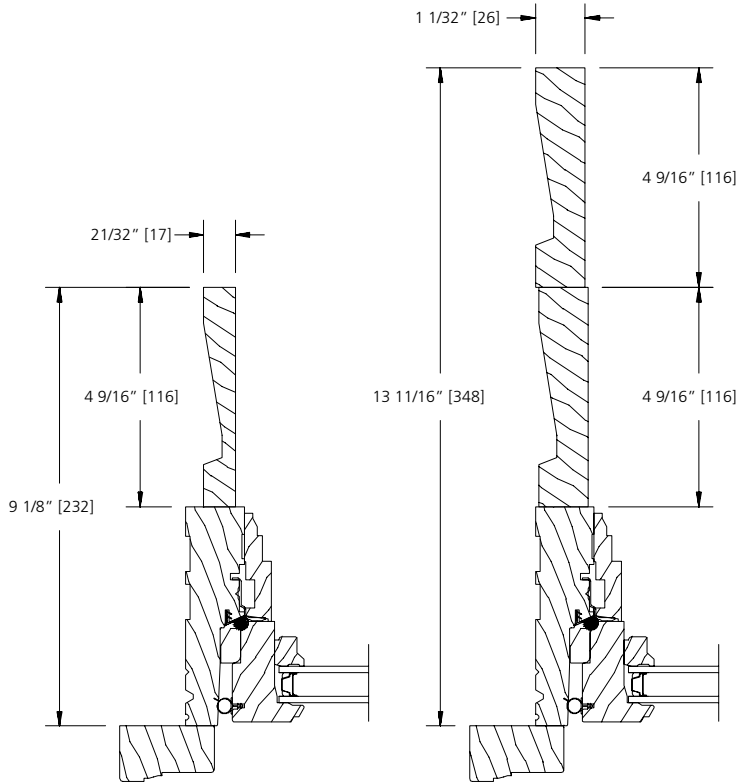

4 9/16\"/>

4 9/16\"/>

SCALE: 3" = 1'

SPECIALTY TRIM & MULLION DETAILS

STANDARD MULLION DETAILS

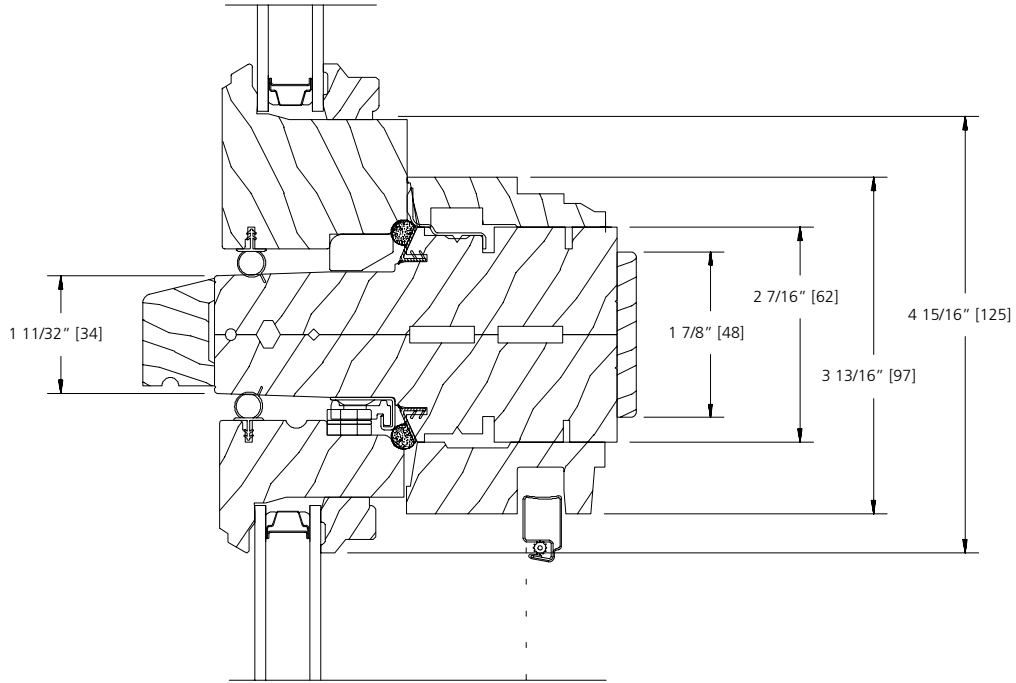

HEAD/SILL

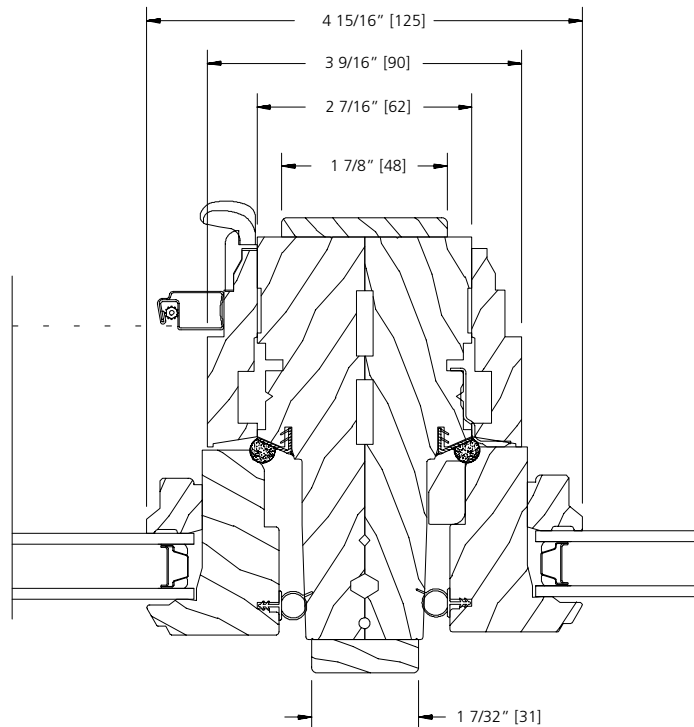

SIDE JAMB

SPECIALTY TRIM & MULLION DETAILS

**SPREAD MULLION DETAILS
WOOD CASEMENT & AWNINGS**

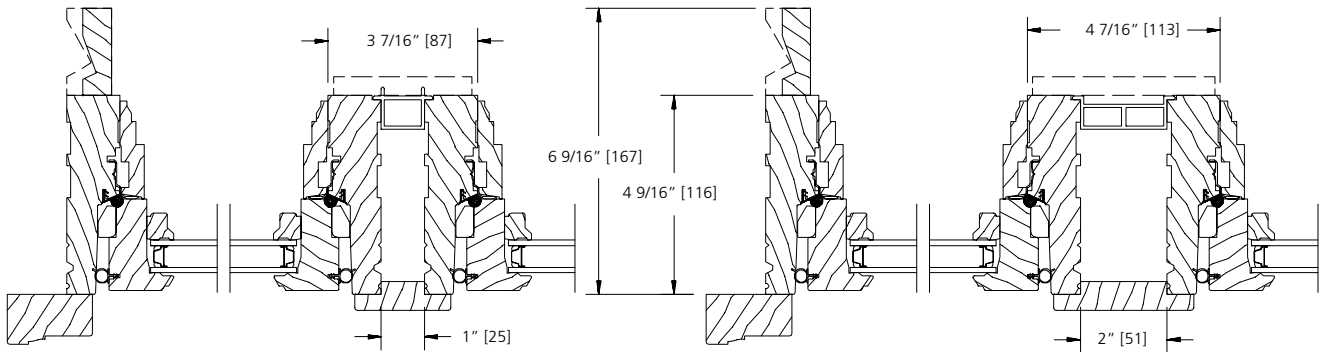
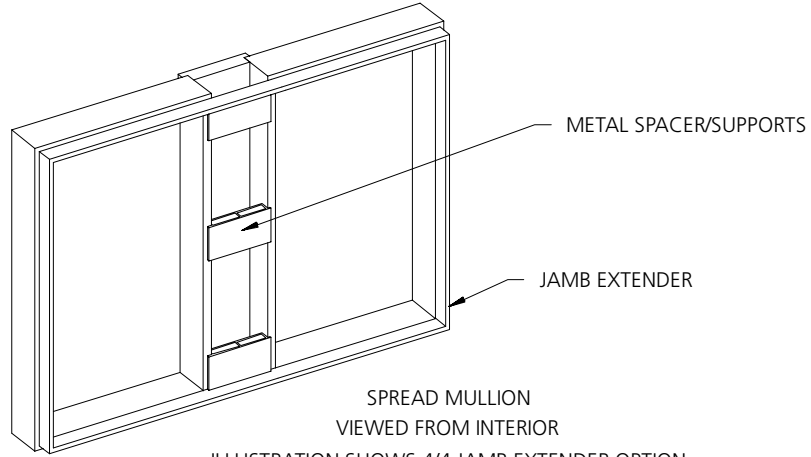

1" SPREAD MULLION

2" SPREAD MULLION

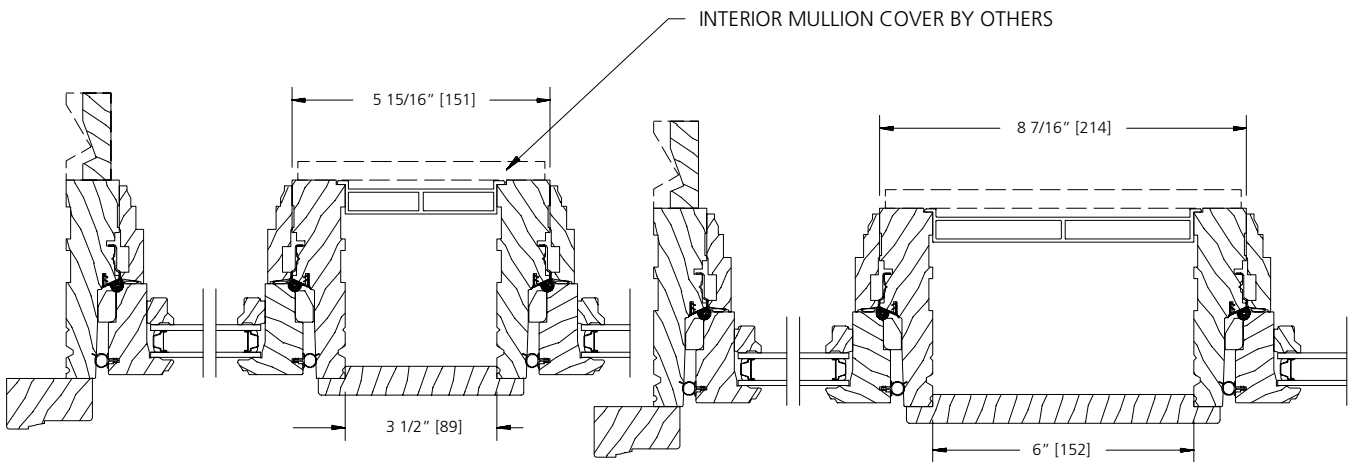

3 1/2" SPREAD MULLION

6" SPREAD MULLION

SPECIALTY TRIM & MULLION DETAILS

STUD POCKET DETAILS

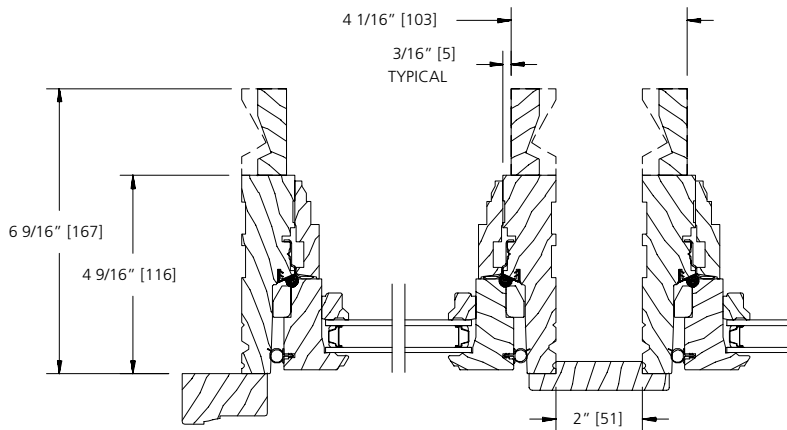
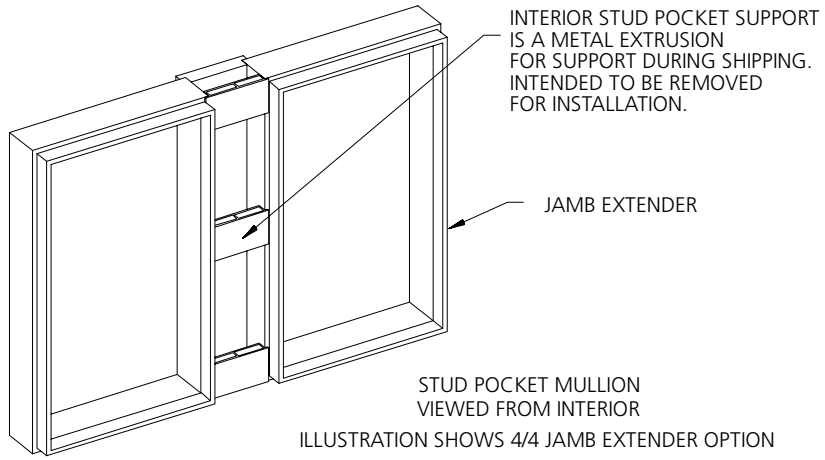

2" STUD POCKET

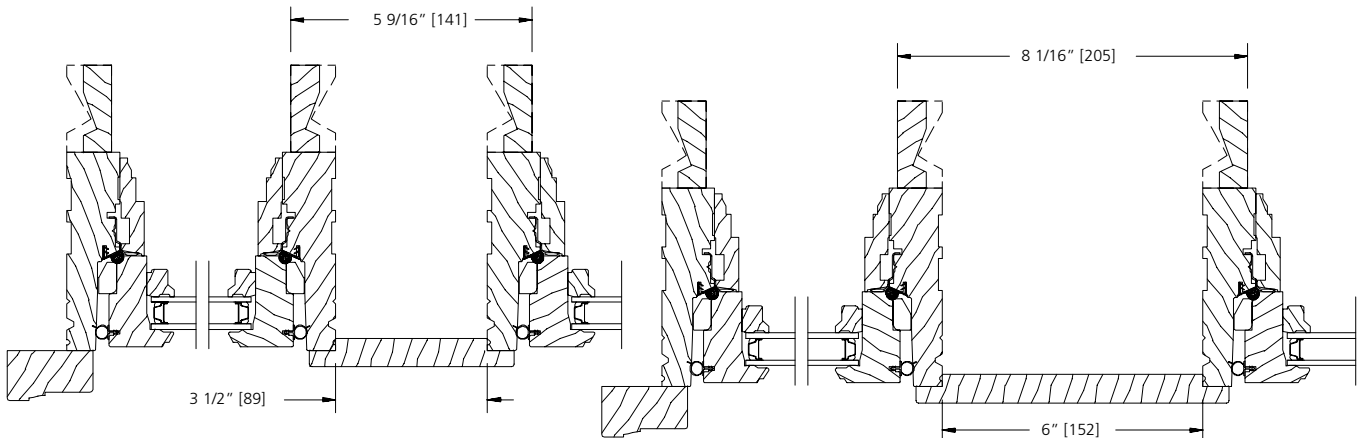

3 1/2" STUD POCKET

6" STUD POCKET

LITE CUT INFORMATION

Wood casement windows are available with removable grilles in 7/8", 1-1/8" and 1-3/8" widths, Airspace (between the panes) grilles, and Simulated Divided Lites. Standard lite cuts are rectangular.

LITE CUT OPTIONS

Special lite cut patterns can include a wide variety of straight line and radius patterns. The illustrations shown here represent just a few of the possibilities. Rectangular, horizontal, vertical and Prairie lite patterns are available in all standard size wood casement windows. Uneven, diamond, radius and Gothic lite cuts are available, subject to approval. Approvals are based on the ability to fulfill the design requirement while maintaining the construction integrity of the finished product.

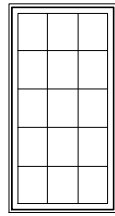

RECTANGULAR

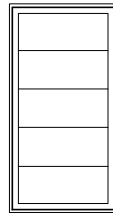

HORIZONTAL

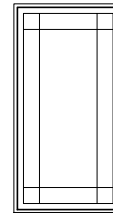

PRAIRIE

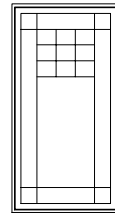

UNEVEN

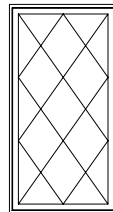

DIAMOND

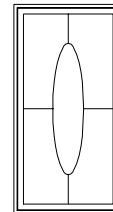

RADIUS

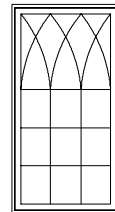

GOTHIC

BAR ALIGNMENT

Alignment of divided lite muntin bars from one window to the next is often required by fine architectural design. Wood grilles, GBG (Grilles between the Glass), and Simulated Divided Lites may be specified with muntin bars aligned.

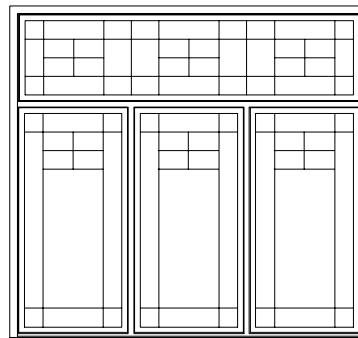

DAYLIGHT OPENING INFORMATION
STATIONARY CASEMENT

Bookcode	Frame Width	Frame Height	DLO Sq.Ft (standard bottom rail)	Bookcode	Frame Width	Frame Height	DLO Sq.Ft (standard bottom rail)
CWC1814	18	14	0.7682	CWC2814	28	14	1.3563
CWC1818	18	18	1.1310	CWC2818	28	18	1.9969
CWC1820	18	20	1.3124	CWC2820	28	20	2.3172
CWC1824	18	24	1.6752	CWC2824	28	24	2.9578
CWC1830	18	30	2.2195	CWC2830	28	30	3.9187
CWC1832	18	32	2.4009	CWC2832	28	32	4.2390
CWC1836	18	36	2.7637	CWC2836	28	36	4.8796
CWC1840	18	40	3.1266	CWC2840	28	40	5.5202
CWC1842	18	42	3.3080	CWC2842	28	42	5.8405
CWC1848	18	48	3.8522	CWC2848	28	48	6.8014
CWC1854	18	54	4.3965	CWC2854	28	54	7.7624
CWC1856	18	56	4.5779	CWC2856	28	56	8.0827
CWC1860	18	60	4.9407	CWC2860	28	60	8.7233
CWC1864	18	64	5.3036	CWC2864	28	64	9.3639
CWC1866	18	66	5.4850	CWC2866	28	66	9.6842
CWC1872	18	72	6.0292	CWC2872	28	72	10.6451
CWC1878	18	78	6.5735	CWC2878	28	78	11.6060
CWC1884	18	84	7.1177	CWC2884	28	84	12.5669
CWC2014	20	14	0.8858	CWC3014	30	14	1.4739
CWC2018	20	18	1.3042	CWC3018	30	18	2.1700
CWC2020	20	20	1.5134	CWC3020	30	20	2.5181
CWC2024	20	24	1.9318	CWC3024	30	24	3.2143
CWC2030	20	30	2.5593	CWC3030	30	30	4.2585
CWC2032	20	32	2.7685	CWC3032	30	32	4.6066
CWC2036	20	36	3.1869	CWC3036	30	36	5.3028
CWC2040	20	40	3.6053	CWC3040	30	40	5.9990
CWC2042	20	42	3.8145	CWC3042	30	42	6.3470
CWC2048	20	48	4.4421	CWC3048	30	48	7.3913
CWC2054	20	54	5.0697	CWC3054	30	54	8.4355
CWC2056	20	56	5.2789	CWC3056	30	56	8.7836
CWC2060	20	60	5.6973	CWC3060	30	60	9.4798
CWC2064	20	64	6.1156	CWC3064	30	64	10.1760
CWC2066	20	66	6.3248	CWC3066	30	66	10.5240
CWC2072	20	72	6.9524	CWC3072	30	72	11.5683
CWC2078	20	78	7.5800	CWC3078	30	78	12.6125
CWC2084	20	84	8.2076	CWC3084	30	84	13.6568
CWC2414	24	14	1.1210	CWC3214	32	14	1.5915
CWC2418	24	18	1.6505	CWC3218	32	18	2.3432
CWC2420	24	20	1.9153	CWC3220	32	20	2.7191
CWC2424	24	24	2.4448	CWC3224	32	24	3.4708
CWC2430	24	30	3.2390	CWC3230	32	30	4.5984
CWC2432	24	32	3.5038	CWC3232	32	32	4.9742
CWC2436	24	36	4.0333	CWC3236	32	36	5.7260
CWC2440	24	40	4.5628	CWC3240	32	40	6.4777
CWC2442	24	42	4.8275	CWC3242	32	42	6.8535
CWC2448	24	48	5.6218	CWC3248	32	48	7.9811
CWC2454	24	54	6.4160	CWC3254	32	54	9.1087
CWC2456	24	56	6.6808	CWC3256	32	56	9.4846
CWC2460	24	60	7.2103	CWC3260	32	60	10.2363
CWC2464	24	64	7.7398	CWC3264	32	64	10.9880
CWC2466	24	66	8.0045	CWC3266	32	66	11.3639
CWC2472	24	72	8.7988	CWC3272	32	72	12.4915
CWC2478	24	78	9.5930	CWC3278	32	78	13.6190
CWC2484	24	84	10.3873	CWC3284	32	84	14.7466

Continued on next page

**DAYLIGHT OPENING INFORMATION
STATIONARY CASEMENT**

Bookcode	Frame Width	Frame Height	DLO Sq.Ft (standard bottom rail)	Bookcode	Frame Width	Frame Height	DLO Sq.Ft (standard bottom rail)
CWC3614	36	14	1.8267	CWC4814	48	14	2.5324
CWC3618	36	18	2.6896	CWC4818	48	18	3.7286
CWC3620	36	20	3.1210	CWC4820	48	20	4.3267
CWC3624	36	24	3.9838	CWC4824	48	24	5.5229
CWC3630	36	30	5.2781	CWC4830	48	30	7.3171
CWC3632	36	32	5.7095	CWC4832	48	32	7.9152
CWC3636	36	36	6.5723	CWC4836	48	36	9.1114
CWC3640	36	40	7.4351	CWC4840	48	40	10.3075
CWC3642	36	42	7.8666	CWC4842	48	42	10.9056
CWC3648	36	48	9.1608	CWC4848	48	48	12.6999
CWC3654	36	54	10.4551	CWC4854	48	54	14.4941
CWC3656	36	56	10.8865	CWC4856	48	56	15.0922
CWC3660	36	60	11.7493	CWC4860	48	60	16.2884
CWC3664	36	64	12.6121	CWC4864	48	64	17.4845
CWC3666	36	66	13.0436	CWC4866	48	66	18.0826
CWC3672	36	72	14.3378	CWC4872	48	72	19.8769
CWC3678	36	78	15.6321	CWC4878	48	78	21.6711
CWC3684	36	84	16.9263	CWC4884	48	84	23.4654
CWC4014	40	14	2.0620	CWC5414	54	14	2.8853
CWC4018	40	18	3.0359	CWC5418	54	18	4.2481
CWC4020	40	20	3.5229	CWC5420	54	20	4.9295
CWC4024	40	24	4.4968	CWC5424	54	24	6.2924
CWC4030	40	30	5.9577	CWC5430	54	30	8.3366
CWC4032	40	32	6.4447	CWC5432	54	32	9.0180
CWC4036	40	36	7.4187	CWC5436	54	36	10.3809
CWC4040	40	40	8.3926	CWC5440	54	40	11.7437
CWC4042	40	42	8.8796	CWC5442	54	42	12.4251
CWC4048	40	48	10.3405	CWC5448	54	48	14.4694
CWC4054	40	54	11.8014	CWC5454	54	54	16.5136
CWC4056	40	56	12.2884	CWC5456	54	56	17.1950
CWC4060	40	60	13.2623	CWC5460	54	60	18.5579
CWC4064	40	64	14.2363	CWC5464	54	64	19.9207
CWC4066	40	66	14.7232	CWC5466	54	66	20.6021
CWC4072	40	72	16.1842	CWC5472	54	72	22.6464
CWC4078	40	78	17.6451	CWC5478	54	78	24.6906
CWC4084	40	84	19.1060	CWC5484	54	84	26.7349
CWC4214	42	14	2.1796	CWC5614	56	14	3.0029
CWC4218	42	18	3.2091	CWC5618	56	18	4.4213
CWC4220	42	20	3.7238	CWC5620	56	20	5.1305
CWC4224	42	24	4.7533	CWC5624	56	24	6.5489
CWC4230	42	30	6.2976	CWC5630	56	30	8.6765
CWC4232	42	32	6.8123	CWC5632	56	32	9.3857
CWC4236	42	36	7.8418	CWC5636	56	36	10.8040
CWC4240	42	40	8.8713	CWC5640	56	40	12.2224
CWC4242	42	42	9.3861	CWC5642	56	42	12.9316
CWC4248	42	48	10.9303	CWC5648	56	48	15.0592
CWC4254	42	54	12.4746	CWC5654	56	54	17.1868
CWC4256	42	56	12.9893	CWC5656	56	56	17.8960
CWC4260	42	60	14.0188	CWC5660	56	60	19.3144
CWC4264	42	64	15.0483	CWC5664	56	64	20.7328
CWC4266	42	66	15.5631	CWC5666	56	66	21.4420
CWC4272	42	72	17.1073	CWC5672	56	72	23.5695
CWC4278	42	78	18.6516	CWC5678	56	78	25.6971
CWC4284	42	84	20.1958	CWC5684	56	84	27.8247

Continued on next page

**DAYLIGHT OPENING INFORMATION
STATIONARY CASEMENT**

Bookcode	Frame Width	Frame Height	DLO Sq.Ft (standard bottom rail)
CWC6014	60	14	3.2381
CWC6018	60	18	4.7676
CWC6020	60	20	5.5324
CWC6024	60	24	7.0619
CWC6030	60	30	9.3561
CWC6032	60	32	10.1209
CWC6036	60	36	11.6504
CWC6040	60	40	13.1799
CWC6042	60	42	13.9446
CWC6048	60	48	16.2389
CWC6054	60	54	18.5331
CWC6056	60	56	19.2979
CWC6060	60	60	20.8274
CWC6064	60	64	22.3569
CWC6066	60	66	23.1216
CWC6072	60	72	25.4159
CWC6078	60	78	27.7101
CWC6084	60	84	30.0044
CWC6614	66	14	3.5910
CWC6618	66	18	5.2872
CWC6620	66	20	6.1352
CWC6624	66	24	7.8314
CWC6630	66	30	10.3757
CWC6632	66	32	11.2237
CWC6636	66	36	12.9199
CWC6640	66	40	14.6161
CWC6642	66	42	15.4642
CWC6648	66	48	18.0084
CWC6654	66	54	20.5527
CWC6656	66	56	21.4007
CWC6660	66	60	23.0969
CWC6664	66	64	24.7931
CWC6666	66	66	25.6412
CWC6672	66	72	28.1854
CWC6678	66	78	30.7297
CWC6684	66	84	33.2739

Bookcode	Frame Width	Frame Height	DLO Sq.Ft (standard bottom rail)
CWC7214	72	14	3.9439
CWC7218	72	18	5.8067
CWC7220	72	20	6.7381
CWC7224	72	24	8.6009
CWC7230	72	30	11.3952
CWC7232	72	32	12.3266
CWC7236	72	36	14.1894
CWC7240	72	40	16.0523
CWC7242	72	42	16.9837
CWC7248	72	48	19.7779
CWC7254	72	54	22.5722
CWC7256	72	56	23.5036
CWC7260	72	60	25.3664
CWC7264	72	64	27.2293
CWC7266	72	66	28.1607
CWC7272	72	72	30.9549
CWC7278	72	78	33.7492
CWC7284	72	84	36.5434

DAYLIGHT & CLEAR OPENING INFORMATION
OPERATING CASEMENT

Bookcode	Frame Width	Frame Height	DLO Sq.Ft	Clear Opening Width	Clear Opening Height	Clear Opening Sq. Ft.
CWC1818	18	18	1.1310	8.1250	13.3125	0.7511
CWC1820	18	20	1.3124	8.1250	15.3125	0.8640
CWC1824	18	24	1.6752	8.1250	19.3125	1.0897
CWC1830	18	30	2.2195	8.1250	25.3125	1.4282
CWC1832	18	32	2.4009	8.1250	27.3125	1.5411
CWC1836	18	36	2.7637	8.1250	31.3125	1.7668
CWC1840	18	40	3.1266	8.1250	35.3125	1.9925
CWC1842	18	42	3.3080	8.1250	37.3125	2.1053
CWC1848	18	48	3.8522	8.1250	43.3125	2.4438
CWC1854	18	54	4.3965	8.1250	49.3125	2.7824
CWC1856	18	56	4.5779	8.1250	51.3125	2.8952
CWC1860	18	60	4.9407	8.1250	55.3125	3.1209
CWC1864	18	64	5.3036	8.1250	59.3125	3.3466
CWC1866	18	66	5.4850	8.1250	61.3125	3.4595
CWC1872	18	72	6.0292	8.1250	67.3125	3.7980
CWC1878	18	78	6.5735	8.1250	73.3125	4.1366
CWC1884	18	84	7.1177	8.1250	79.3125	4.4751
CWC2020	20	20	1.5134	10.1250	15.3125	1.0767
CWC2024	20	24	1.9318	10.1250	19.3125	1.3579
CWC2030	20	30	2.5593	10.1250	25.3125	1.7798
CWC2032	20	32	2.7685	10.1250	27.3125	1.9204
CWC2036	20	36	3.1869	10.1250	31.3125	2.2017
CWC2040	20	40	3.6053	10.1250	35.3125	2.4829
CWC2042	20	42	3.8145	10.1250	37.3125	2.6235
CWC2048	20	48	4.4421	10.1250	43.3125	3.0454
CWC2054	20	54	5.0697	10.1250	49.3125	3.4673
CWC2056	20	56	5.2789	10.1250	51.3125	3.6079
CWC2060	20	60	5.6973	10.1250	55.3125	3.8892
CWC2064	20	64	6.1156	10.1250	59.3125	4.1704
CWC2066	20	66	6.3248	10.1250	61.3125	4.3110
CWC2072	20	72	6.9524	10.1250	67.3125	4.7329
CWC2078	20	78	7.5800	10.1250	73.3125	5.1548
CWC2084	20	84	8.2076	10.1250	79.3125	5.5767
CWC2424	24	24	2.4448	14.1250	19.3125	1.8944
CWC2430	24	30	3.2390	14.1250	25.3125	2.4829
CWC2432	24	32	3.5038	14.1250	27.3125	2.6791
CWC2436	24	36	4.0333	14.1250	31.3125	3.0715
CWC2440	24	40	4.5628	14.1250	35.3125	3.4638
CWC2442	24	42	4.8275	14.1250	37.3125	3.6600
CWC2448	24	48	5.6218	14.1250	43.3125	4.2485
CWC2454	24	54	6.4160	14.1250	49.3125	4.8371
CWC2456	24	56	6.6808	14.1250	51.3125	5.0333
CWC2460	24	60	7.2103	14.1250	55.3125	5.4256
CWC2464	24	64	7.7398	14.1250	59.3125	5.8180
CWC2466	24	66	8.0045	14.1250	61.3125	6.0142
CWC2472	24	72	8.7988	14.1250	67.3125	6.6027
CWC2478	24	78	9.5930	14.1250	73.3125	7.1912
CWC2484	24	84	10.3873	14.1250	79.3125	7.7798

DAYLIGHT & CLEAR OPENING INFORMATION
OPERATING CASEMENT

Bookcode	Frame Width	Frame Height	DLO Sq.Ft	Clear Opening Width	Clear Opening Height	Clear Opening Sq. Ft.
CWC2830	28	30	3.9187	18.1250	25.3125	3.1860
CWC2832	28	32	4.2390	18.1250	27.3125	3.4378
CWC2836	28	36	4.8796	18.1250	31.3125	3.9412
CWC2840	28	40	5.5202	18.1250	35.3125	4.4447
CWC2842	28	42	5.8405	18.1250	37.3125	4.6965
CWC2848	28	48	6.8014	20.5000	43.3125	6.1660
CWC2854	28	54	7.7624	20.5000	49.3125	7.0202
CWC2856	28	56	8.0827	20.5000	51.3125	7.3049
CWC2860	28	60	8.7233	20.5000	55.3125	7.8743
CWC2864	28	64	9.3639	20.5000	59.3125	8.4438
CWC2866	28	66	9.6842	20.5000	61.3125	8.7285
CWC2872	28	72	10.6451	20.5000	67.3125	9.5827
CWC2878	28	78	11.6060	20.5000	73.3125	10.4368
CWC2884	28	84	12.5669	20.5000	79.3125	11.2910
CWC3030	30	30	4.2585	20.1250	25.3125	3.5376
CWC3032	30	32	4.6066	20.1250	27.3125	3.8171
CWC3036	30	36	5.3028	20.1250	31.3125	4.3761
CWC3040	30	40	5.9990	20.1250	35.3125	4.9352
CWC3042	30	42	6.3470	22.5000	37.3125	5.8301
CWC3048	30	48	7.3913	20.1250	43.3125	6.0532
CWC3054	30	54	8.4355	20.1250	49.3125	6.8918
CWC3056	30	56	8.7836	20.1250	51.3125	7.1713
CWC3060	30	60	9.4798	20.1250	55.3125	7.7303
CWC3064	30	64	10.1760	20.1250	59.3125	8.2893
CWC3066	30	66	10.5240	20.1250	61.3125	8.5688
CWC3072	30	72	11.5683	20.1250	67.3125	9.4074
CWC3078	30	78	12.6125	20.1250	73.3125	10.2459
CWC3084	30	84	13.6568	20.1250	79.3125	11.0845
CWC3232	32	32	4.9742	22.1250	27.3125	4.1965
CWC3236	32	36	5.7260	22.1250	31.3125	4.8110
CWC3240	32	40	6.4777	22.1250	35.3125	5.4256
CWC3242	32	42	6.8535	22.1250	37.3125	5.7329
CWC3248	32	48	7.9811	22.1250	43.3125	6.6548
CWC3254	32	54	9.1087	22.1250	49.3125	7.5767
CWC3256	32	56	9.4846	22.1250	51.3125	7.8840
CWC3260	32	60	10.2363	22.1250	55.3125	8.4985
CWC3264	32	64	10.9880	22.1250	59.3125	9.1131
CWC3266	32	66	11.3639	22.1250	61.3125	9.4204
CWC3272	32	72	12.4915	22.1250	67.3125	10.3423
CWC3278	32	78	13.6190	22.1250	73.3125	11.2642
CWC3284	32	84	14.7466	22.1250	79.3125	12.1860
CWC3636	36	36	6.5723	26.1250	31.3125	5.6808
CWC3640	36	40	7.4351	26.1250	35.3125	6.4065
CWC3642	36	42	7.8666	26.1250	37.3125	6.7694
CWC3648	36	48	9.1608	26.1250	43.3125	7.8579
CWC3654	36	54	10.4551	26.1250	49.3125	8.9465
CWC3656	36	56	10.8865	26.1250	51.3125	9.3093
CWC3660	36	60	11.7493	26.1250	55.3125	10.0350
CWC3664	36	64	12.6121	26.1250	59.3125	10.7607
CWC3666	36	66	13.0436	26.1250	61.3125	11.1235
CWC3672	36	72	14.3378	26.1250	67.3125	12.2121
CWC3678	36	78	15.6321	26.1250	73.3125	13.3006
CWC3684	36	84	16.9263	26.1250	79.3125	14.3892

Requires an Egress Hinge to exceed 20" in width, 24" in height and 5.7 sq. ft.

Basic Unit Clear Opening exceeds 20" in width, 24" in height and 5.7 sq. ft.

**DAYLIGHT OPENING INFORMATION
SECTOR TOP CASEMENT**

CLEAR OPENINGS
THE CLEAR OPENINGS SHOWN ABOVE ILLUSTRATE THE VERTICAL CLEAR OPENING TO THE INTERIOR SPRINGLINE OF FRAME FEATURES.

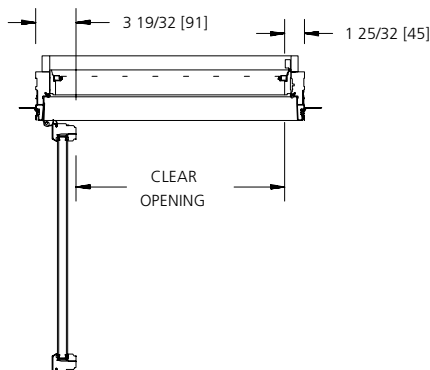
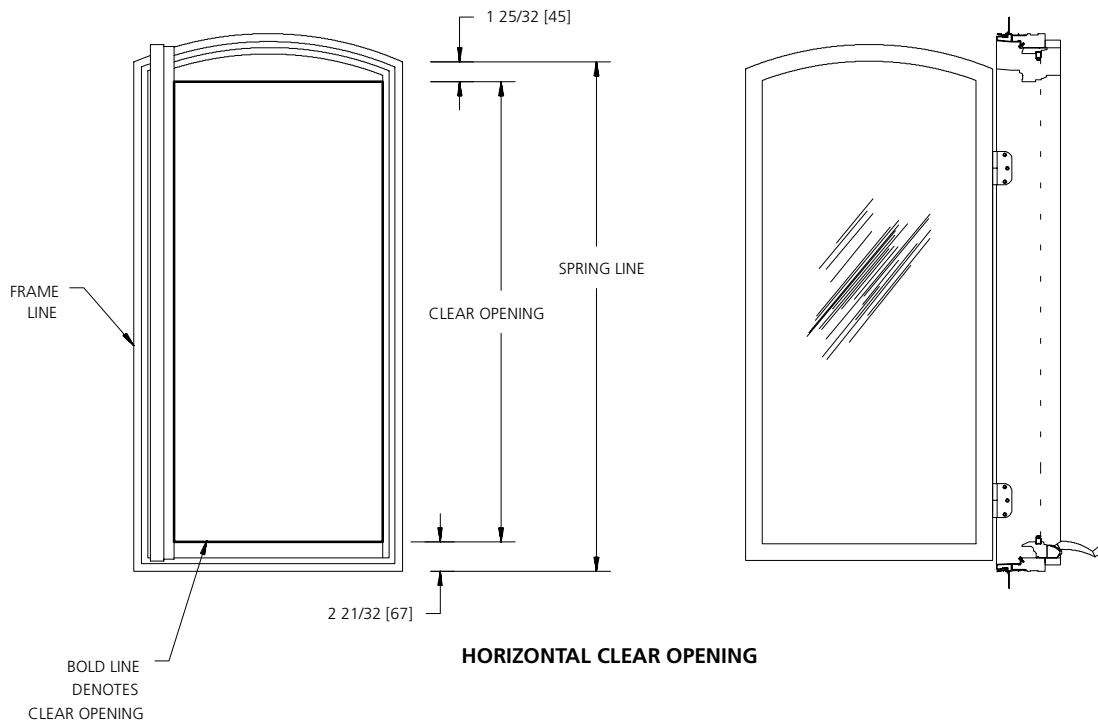
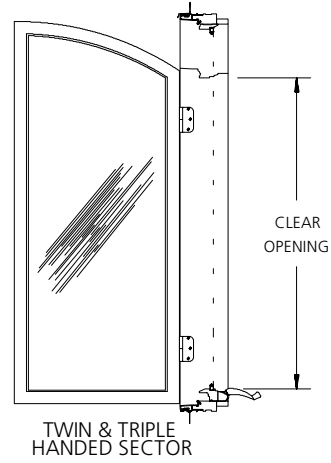
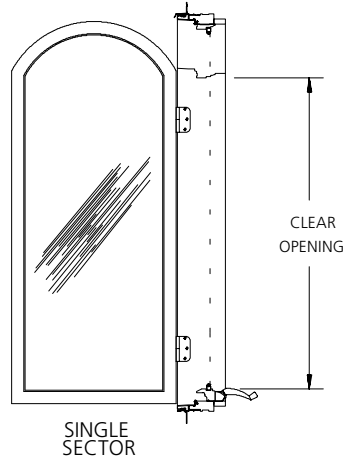

CLEAR OPENING INFORMATION
SECTOR TOP CASEMENT

24" WIDE - SINGLES, TWINS & TRIPLES

Book Code	Frame Width	Frame Height	Clear Opening Sq. Ft.	Clear Opening Width	Clear Opening Height	Daylight Opening Sq. Ft.
CWCS2424	24	24	2.21	18.63	17.06	2.35
CWCS2430	24	30	2.98	18.63	23.06	3.11
CWCS2432	24	32	3.24	18.63	25.06	3.37
CWCS2436	24	36	3.76	18.63	29.06	3.87
CWCS2440	24	40	4.28	18.63	33.06	4.38
CWCS2442	24	42	4.54	18.63	35.06	4.63
CWCS2448	24	48	5.31	18.63	41.06	5.40
CWCS2454	24	54	6.09	18.63	47.06	6.16
CWCS2456	24	56	6.35	18.63	49.06	6.41
CWCS2460	24	60	6.86	18.63	53.06	6.92
CWCS2464	24	64	7.38	18.63	57.06	7.43
CWCS2466	24	66	7.64	18.63	59.06	7.69
CWCS2472	24	72	8.42	18.63	65.06	8.45
CWCS2478	24	78	9.19	18.63	71.06	9.21
CWCS2484	24	84	9.97	18.63	77.06	9.97
CWCS2424-2	48	24	1.86	18.63	14.38	4.43
CWCS2430-2	48	30	2.64	18.63	20.38	5.96
CWCS2432-2	48	32	2.90	18.63	22.38	6.47
CWCS2436-2	48	36	3.41	18.63	26.38	7.48
CWCS2440-2	48	40	3.93	18.63	30.38	8.49
CWCS2442-2	48	42	4.19	18.63	32.38	9.00
CWCS2448-2	48	48	4.97	18.63	38.38	10.53
CWCS2454-2	48	54	5.74	18.63	44.38	12.05
CWCS2456-2	48	56	6.00	18.63	46.38	12.56
CWCS2460-2	48	60	6.52	18.63	50.38	13.59
CWCS2464-2	48	64	7.04	18.63	54.38	14.60
CWCS2466-2	48	66	7.29	18.63	56.38	15.11
CWCS2472-2	48	72	8.07	18.63	62.38	16.63
CWCS2478-2	48	78	8.85	18.63	68.38	18.16
CWCS2484-2	48	84	9.62	18.63	74.38	19.68
CWCS2424-3	72	24	1.56	18.63	12.06	6.33
CWCS2430-3	72	30	2.34	18.63	18.06	8.63
CWCS2432-3	72	32	2.60	18.63	20.06	9.39
CWCS2436-3	72	36	3.11	18.63	24.06	10.91
CWCS2440-3	72	40	3.37	18.63	26.06	12.43
CWCS2442-3	72	42	3.89	18.63	30.06	13.19
CWCS2448-3	72	48	4.67	18.63	36.06	15.49
CWCS2454-3	72	54	5.44	18.63	42.06	17.77
CWCS2456-3	72	56	5.70	18.63	44.06	18.53
CWCS2460-3	72	60	6.22	18.63	48.06	20.05
CWCS2464-3	72	64	6.74	18.63	52.06	21.59
CWCS2466-3	72	66	6.99	18.63	54.06	22.35
CWCS2472-3	72	72	7.77	18.63	60.06	24.63
CWCS2478-3	72	78	8.55	18.63	66.06	26.93
CWCS2484-3	72	84	6.04	18.63	46.67	29.21

CLEAR OPENING INFORMATION
SECTOR TOP CASEMENT

30" WIDE - SINGLES, TWINS & TRIPLES

Book Code	Frame Width	Frame Height	Clear Opening Sq. Ft.	Clear Opening Width	Clear Opening Height	Daylight Opening Sq. Ft.
CWCS3024	30	24	2.66	24.63	15.53	3.04
CWCS3030	30	30	3.68	24.63	21.53	4.08
CWCS3032	30	32	4.02	24.63	23.53	4.43
CWCS3036	30	36	4.71	24.63	27.53	5.13
CWCS3040	30	40	5.39	24.63	31.50	5.83
CWCS3042 E	30	42	5.74	24.63	33.53	6.17
CWCS3048 E	30	48	6.76	24.63	39.53	7.22
CWCS3054 E	30	54	7.79	24.63	45.53	8.26
CWCS3056 E	30	56	8.12	24.63	47.50	8.61
CWCS3060 E	30	60	8.81	24.63	51.53	9.31
CWCS3064 E	30	64	9.49	24.63	55.50	10.00
CWCS3066 E	30	66	9.84	24.63	57.53	10.35
CWCS3072 E	30	72	10.87	24.63	63.53	11.40
CWCS3078 E	30	78	11.89	24.63	69.53	12.44
CWCS3084 E	30	84	2.32	24.63	13.58	13.48
CWCS3024-2	60	24	1.91	24.63	11.19	5.51
CWCS3030-2	60	30	2.94	24.63	17.19	7.61
CWCS3032-2	60	32	3.28	24.63	19.19	8.31
CWCS3036-2	60	36	3.97	24.63	23.19	9.69
CWCS3040-2	60	40	4.70	24.63	27.50	11.08
CWCS3042-2	60	42	4.99	24.63	29.19	11.78
CWCS3048-2 E	60	48	6.02	24.63	35.19	13.88
CWCS3054-2 E	60	54	7.05	24.63	41.19	15.96
CWCS3056-2 E	60	56	7.44	24.63	43.50	16.65
CWCS3060-2 E	60	60	8.07	24.63	47.19	18.04
CWCS3064-2 E	60	64	8.81	24.63	51.50	19.44
CWCS3066-2 E	60	66	9.10	24.63	53.19	20.14
CWCS3072-2 E	60	72	10.12	24.63	59.19	22.22
CWCS3078-2 E	60	78	11.15	24.63	65.19	24.32
CWCS3084-2 E	60	84	12.18	24.63	71.19	26.40
CWCS3024-3	90	24	1.28	24.63	7.50	7.60
CWCS3030-3	90	30	2.31	24.63	13.50	10.74
CWCS3032-3	90	32	2.65	24.63	15.50	11.78
CWCS3036-3	90	36	3.34	24.63	19.50	13.88
CWCS3040-3	90	40	4.02	24.63	23.50	15.96
CWCS3042-3	90	42	4.36	24.63	25.50	17.01
CWCS3048-3	90	48	5.39	24.63	31.50	20.14
CWCS3054-3 E	90	54	6.41	24.63	37.50	23.27
CWCS3056-3 E	90	56	6.76	24.63	39.50	24.31
CWCS3060-3 E	90	60	7.44	24.63	43.50	26.41
CWCS3064-3 E	90	64	8.12	24.63	47.50	28.49
CWCS3066-3 E	90	66	8.47	24.63	49.50	29.53
CWCS3072-3 E	90	72	9.49	24.63	55.50	32.67
CWCS3078-3 E	90	78	10.52	24.63	61.50	35.81
CWCS3084-3 E	90	84	11.55	24.63	67.50	38.94

E Basic Unit Clear Opening exceeds 20" in width, 24" in height and a minimum of 5.7 sq. ft.

**CLEAR OPENING INFORMATION
FRENCH CASEMENT STRAIGHTLINE**

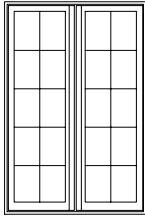

CLEAR OPENING LAYOUT

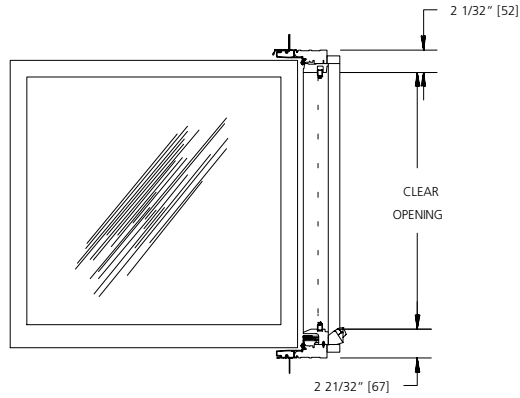

CLEAR OPENING FORMULAS

HORIZONTAL

(Frame/2) - 9 7/16" [239] - Single Sash Open
Frame - 16 1/2" [344] - Both Sash Open

VERTICAL

Frame - 4 9/16" [119]

VERTICAL CLEAR OPENING

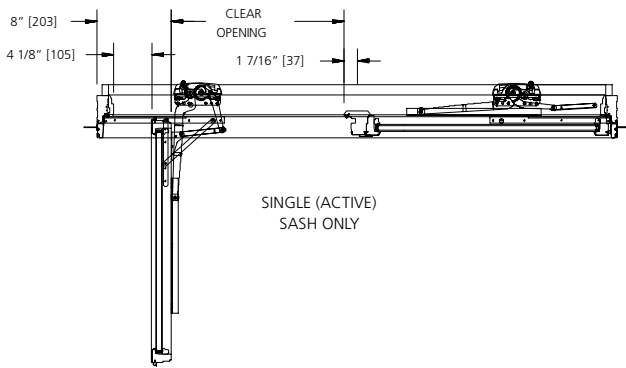

HORIZONTAL CLEAR OPENING

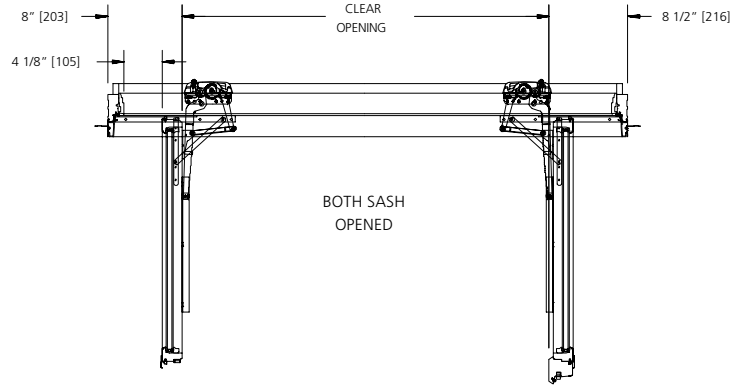

HORIZONTAL CLEAR OPENING

- E** BASIC UNIT CLEAR OPENING EXCEEDS 20" IN WIDTH, 24" IN HEIGHT & A MINIMUM OF 5.7 SQ. FT.
- E*** BASIC UNIT CLEAR OPENING REQUIRES EGRESS HINGES TO EXCEED 20" IN WIDTH, 24" IN HEIGHT & A MINIMUM, OF 5.7 SQ. FT.
- S** STATIONARY UNIT

CLEAR OPENING INFORMATION
FRENCH CASEMENT
STRAIGHTLINE

Book Code		Frame Width	Frame Height	Clear Opening Sq. Ft. SINGLE SASH	Clear Opening Sq. Ft. BOTH SASH	Clear Opening Width SINGLE SASH	Clear Opening Width BOTH SASH	Clear Opening Height	Daylight Opening Sq. Ft.
CWCFR3618	S	36	18	NA	NA	NA	NA	NA	2.26
CWCFR3620	S	36	20	NA	NA	NA	NA	NA	2.62
CWCFR3624	S	36	24	NA	NA	NA	NA	NA	3.35
CWCFR3630		36	30	1.51	3.43	8.56	19.50	25.31	4.44
CWCFR3632		36	32	1.62	3.70	8.56	19.50	27.31	4.80
CWCFR3636		36	36	1.86	4.24	8.56	19.50	31.31	5.53
CWCFR3640		36	40	2.10	4.78	8.56	19.50	35.31	6.25
CWCFR3642		36	42	2.22	5.05	8.56	19.50	37.31	6.62
CWCFR3648		36	48	2.58	5.87	8.56	19.50	43.31	7.70
CWCFR3654		36	54	2.93	6.68	8.56	19.50	49.31	8.79
CWCFR3656		36	56	3.05	6.95	8.56	19.50	51.31	9.16
CWCFR3660		36	60	3.29	7.49	8.56	19.50	55.31	9.88
CWCFR3664		36	64	3.53	8.03	8.56	19.50	59.31	10.61
CWCFR3666		36	66	3.65	8.30	8.56	19.50	61.31	10.97
CWCFR3672		36	72	4.00	9.12	8.56	19.50	67.31	12.06
CWCFR4818	S	48	18	NA	NA	NA	NA	NA	3.30
CWCFR1820	S	48	20	NA	NA	NA	NA	NA	3.83
CWCFR4824	S	48	24	NA	NA	NA	NA	NA	4.89
CWCFR4830		48	30	2.56	5.54	14.56	31.50	25.31	6.48
CWCFR4832	E*	48	32	2.76	5.97	14.56	31.50	27.31	7.01
CWCFR4836	E*	48	36	3.17	6.85	14.56	31.50	31.31	8.07
CWCFR4840	E*	48	40	3.57	7.72	14.56	31.50	35.31	9.13
CWCFR4842	E*	48	42	3.77	8.16	14.56	31.50	37.31	9.66
CWCFR4848	E*	48	48	4.38	9.47	14.56	31.50	43.31	11.24
CWCFR4854	E*	48	54	4.99	10.79	14.56	31.50	49.31	12.83
CWCFR4856	E*	48	56	5.19	11.22	14.56	31.50	51.31	13.36
CWCFR4860	E*	48	60	5.59	12.10	14.56	31.50	55.31	14.42
CWCFR4864	E*	48	64	6.00	12.97	14.56	31.50	59.31	15.48
CWCFR4866	E*	48	66	6.20	13.41	14.56	31.50	61.31	16.01
CWCFR4872	E*	48	72	6.81	14.72	14.56	31.50	67.31	17.60
CWCFR5618	S	56	18	NA	NA	NA	NA	NA	3.99
CWCFR5620	S	56	20	NA	NA	NA	NA	NA	4.63
CWCFR5624	S	56	24	NA	NA	NA	NA	NA	5.92
CWCFR5630	E*	56	30	3.26	6.94	18.56	39.50	25.31	7.84
CWCFR5632	E*	56	32	3.52	7.49	18.56	39.50	27.31	8.48
CWCFR5636	E*	56	36	4.04	8.59	18.56	39.50	31.31	9.76
CWCFR5640	E*	56	40	4.55	9.69	18.56	39.50	35.31	11.04
CWCFR5642	E*	56	42	4.81	10.24	18.56	39.50	37.31	11.68
CWCFR5648	E*	56	48	5.58	11.88	18.56	39.50	43.31	13.60
CWCFR5654	E*	56	54	6.36	13.53	18.56	39.50	49.31	15.52
CWCFR5656	E*	56	56	6.61	14.08	18.56	39.50	51.31	16.17
CWCFR5660	E*	56	60	7.13	15.17	18.56	39.50	55.31	17.45
CWCFR5664	E*	56	64	7.65	16.27	18.56	39.50	59.31	18.73
CWCFR5666	E*	56	66	7.90	16.82	18.56	39.50	61.31	19.37
CWCFR5672	E*	56	72	8.68	18.46	18.56	39.50	67.31	21.29

E* These units require both sash to be opened for the clear opening to exceed 20" in width, 24" in height and a minimum of 5.7 sq ft.

S Stationary unit ONLY

CLEAR OPENING INFORMATION
FRENCH CASEMENT SECTOR TOP

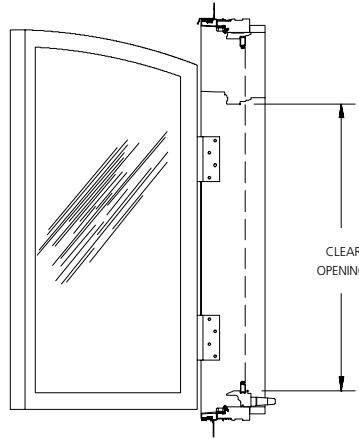
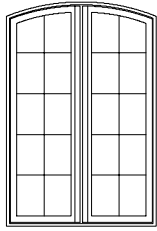

CLEAR OPENING FORMULAS

HORIZONTAL

(Frame/2) - 4 21/32" [118] - Single Sash Open
(Frame/2) - 6 15/16 [176] - Both Sash Open

VERTICAL

(Frame/2) - 4 15/32" [118] - Single Sash Open

VERTICAL CLEAR OPENING

Refer to Clear Opening Information Above

SINGLE (ACTIVE) SASH ONLY

36" Units Width

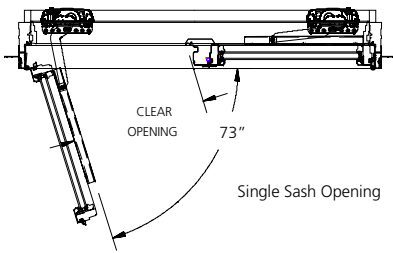

BOTH SASH OPENED

36" Units Width

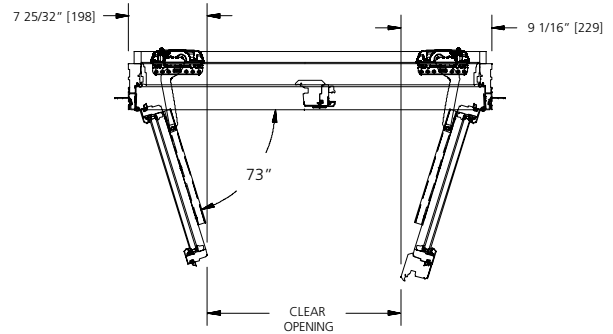

48" & 56 Unit Widths

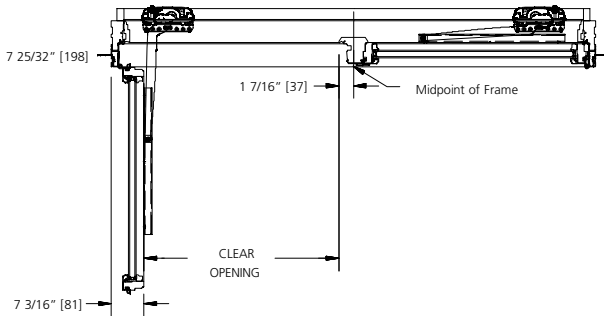

48" & 56 Unit Widths

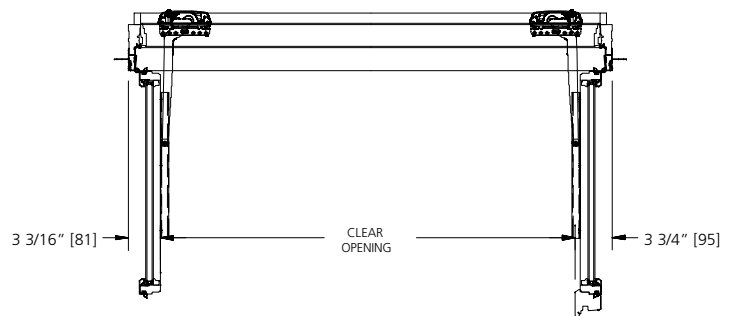

HORIZONTAL CLEAR OPENING

- E** BASIC UNIT CLEAR OPENING EXCEEDS 20" IN WIDTH, 24" IN HEIGHT & A MINIMUM OF 5.7 SQ. FT.
- E*** BASIC UNIT CLEAR OPENING REQUIRES EGRESS HINGES TO EXCEED 20" IN WIDTH, 24" IN HEIGHT & A MINIMUM, OF 5.7 SQ. FT.

CLEAR OPENING INFORMATION
FRENCH CASEMENT
SECTOR TOPS

Book Code	Frame Width	Frame Height	Clear Opening Sq. Ft. SINGLE SASH	Clear Opening Sq. Ft. BOTH SASH	Clear Opening Width SINGLE SASH	Clear Opening Width BOTH SASH	Clear Opening Height	Daylight Opening Sq. Ft.
CWCFS3630	36	30	2.05	2.94	13.37	19.21	22.06	4.34
CWCFS3632	36	32	2.23	3.21	13.37	19.21	24.06	4.70
CWCFS3636	36	36	2.60	3.74	13.37	19.21	28.06	5.43
CWCFS3640	36	40	2.98	4.28	13.37	19.21	32.06	0.00
CWCFS3642	36	42	3.16	4.54	13.37	19.21	34.06	6.52
CWCFS3648	36	48	3.72	5.34	13.37	19.21	40.06	7.61
CWCFS3654	36	54	4.28	6.14	13.37	19.21	46.06	8.69
CWCFS3656	36	56	4.46	6.41	13.37	19.21	48.06	0.00
CWCFS3660	36	60	4.83	6.94	13.37	19.21	52.06	9.79
CWCFS3664	36	64	5.20	7.48	13.37	19.21	56.06	0.00
CWCFS3666	36	66	5.39	7.74	13.37	19.21	58.06	10.87
CWCFS3672	36	72	5.95	8.54	13.37	19.21	64.06	11.97
CWCFS4830	48	30	2.74	5.81	19.36	41.09	20.38	6.04
CWCFS4832	48	32	3.01	6.38	19.36	41.09	22.37	6.56
CWCFS4836 E*	48	36	3.54	7.52	19.36	41.09	26.37	7.63
CWCFS4840 E*	48	40	4.08	8.67	19.36	41.09	30.37	0.00
CWCFS4842 E*	48	42	4.35	9.24	19.36	41.09	32.37	9.22
CWCFS4848 E*	48	48	5.16	10.95	19.36	41.09	38.37	10.80
CWCFS4854 E*	48	54	5.96	12.66	19.36	41.09	44.37	12.40
CWCFS4856 E*	48	56	6.23	13.23	19.36	41.09	46.37	0.00
CWCFS4860 E*	48	60	6.77	14.37	19.36	41.09	50.37	13.98
CWCFS4864 E*	48	64	7.31	15.51	19.36	41.09	54.37	0.00
CWCFS4866 E*	48	66	7.58	16.08	19.36	41.09	56.37	15.58
CWCFS4872 E*	48	72	8.38	17.80	19.36	41.09	62.37	17.16
CWCFS5630	56	30	2.98	6.25	23.36	49.09	18.34	7.11
CWCFS5632	56	32	3.30	6.93	23.36	49.09	20.34	7.75
CWCFS5636 E*	56	36	3.95	8.30	23.36	49.09	24.34	9.04
CWCFS5640 E*	56	40	4.60	9.66	23.36	49.09	28.34	0.00
CWCFS5642 E*	56	42	4.92	10.34	23.36	49.09	30.34	10.95
CWCFS5648 E & E*	56	48	5.89	12.39	23.36	49.09	36.34	12.87
CWCFS5654 E & E*	56	54	6.87	14.43	23.36	49.09	42.34	14.80
CWCFS5656 E & E*	56	56	7.19	15.12	23.36	49.09	44.34	0.00
CWCFS5660 E & E*	56	60	7.84	16.48	23.36	49.09	48.34	16.72
CWCFS5664 E & E*	56	64	8.49	17.84	23.36	49.09	52.34	0.00
CWCFS5666 E & E*	56	66	8.81	18.52	23.36	49.09	54.34	18.63
CWCFS5672 E & E*	56	72	9.79	20.57	23.36	49.09	60.34	20.56

E Basic Unit Clear Opening exceeds 20" in width, 24" in height and a minimum of 5.7 sq. ft.

E* These units require both sash to be opened for the clear opening to exceed 20" in width, 24" in height and a minimum of 5.7 sq ft.

UNIT SIZING, ROUGH OPENINGS & MASONRY OPENINGS

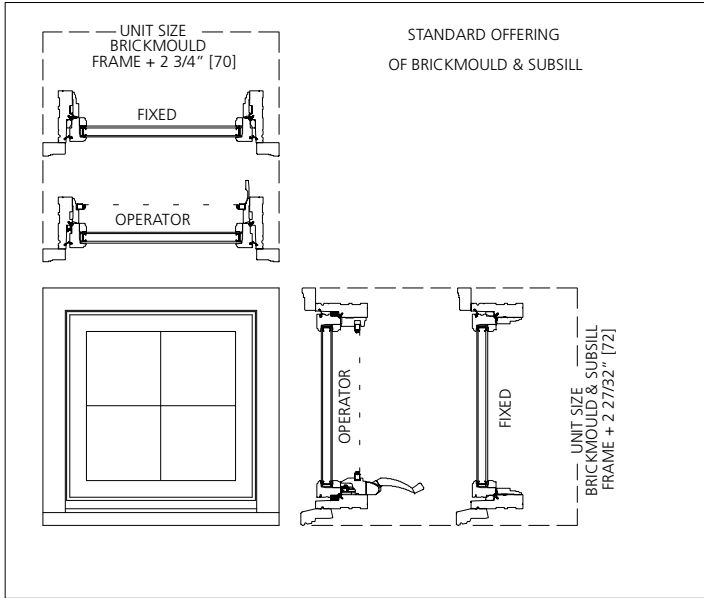

GENERAL NOTES:

UNITS WITH NO TRIM AND SUBSILL:
UNIT SIZE = FRAME SIZE

UNIT SIZE IS ALWAYS THE EXTREME SIZE OF THE WINDOW WITH OR WITHOUT TRIM

MASONRY OPENING:
MASONRY OPENING IS ALWAYS 1/2" OVER THE UNIT SIZE OF THE WINDOW

ROUGH OPENING:

ROUGH OPENING IS ALWAYS 1/2" OVER FRAME SIZE OF THE WINDOW

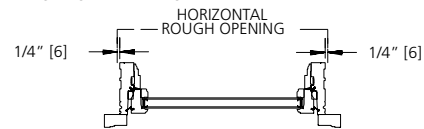

EXCEPTION: SEE DRAWING BELOW

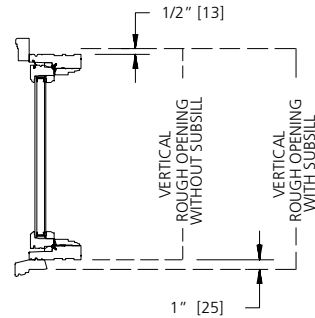

NON-STANDARD UNIT SIZING

EXTERIOR TRIM OFFERINGS WITH SUBSILL

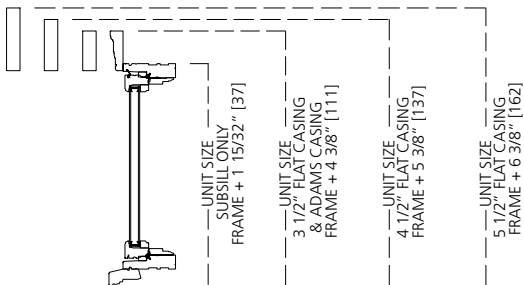

EXTERIOR TRIM OFFERINGS WITHOUT SUBSILL
EXTERIOR TRIM ON ALL 4 SIDES

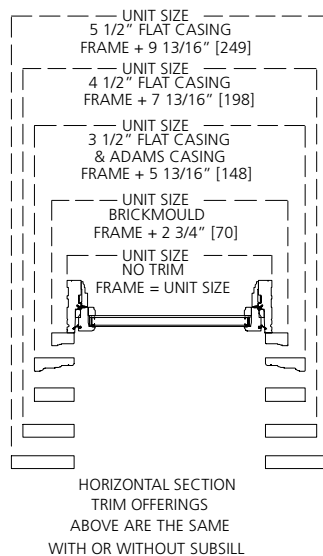
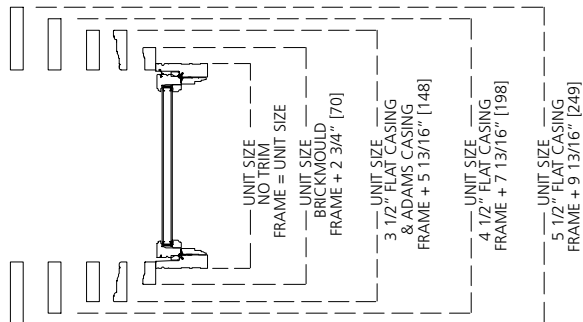

FRAME TO TRIM DIMENSIONS

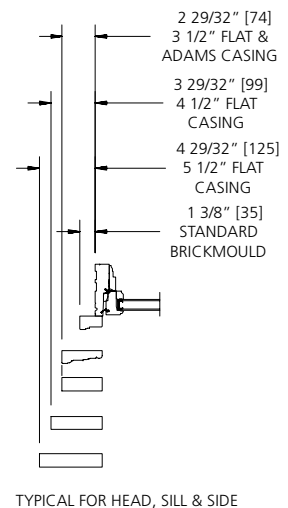

1-WIDE UNIT

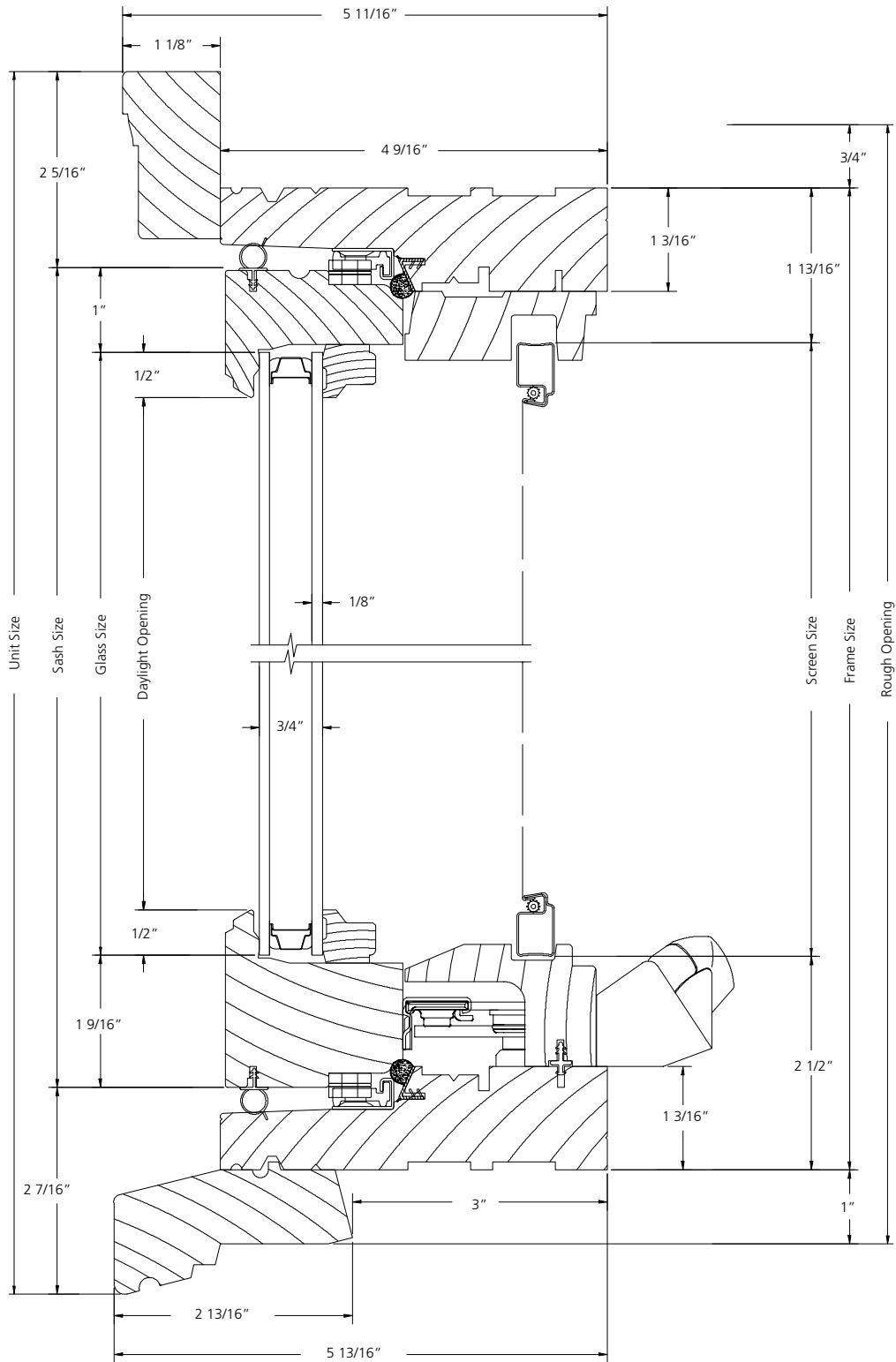

VERTICAL SECTION

SCALE: 6" = 1'

1-WIDE UNIT

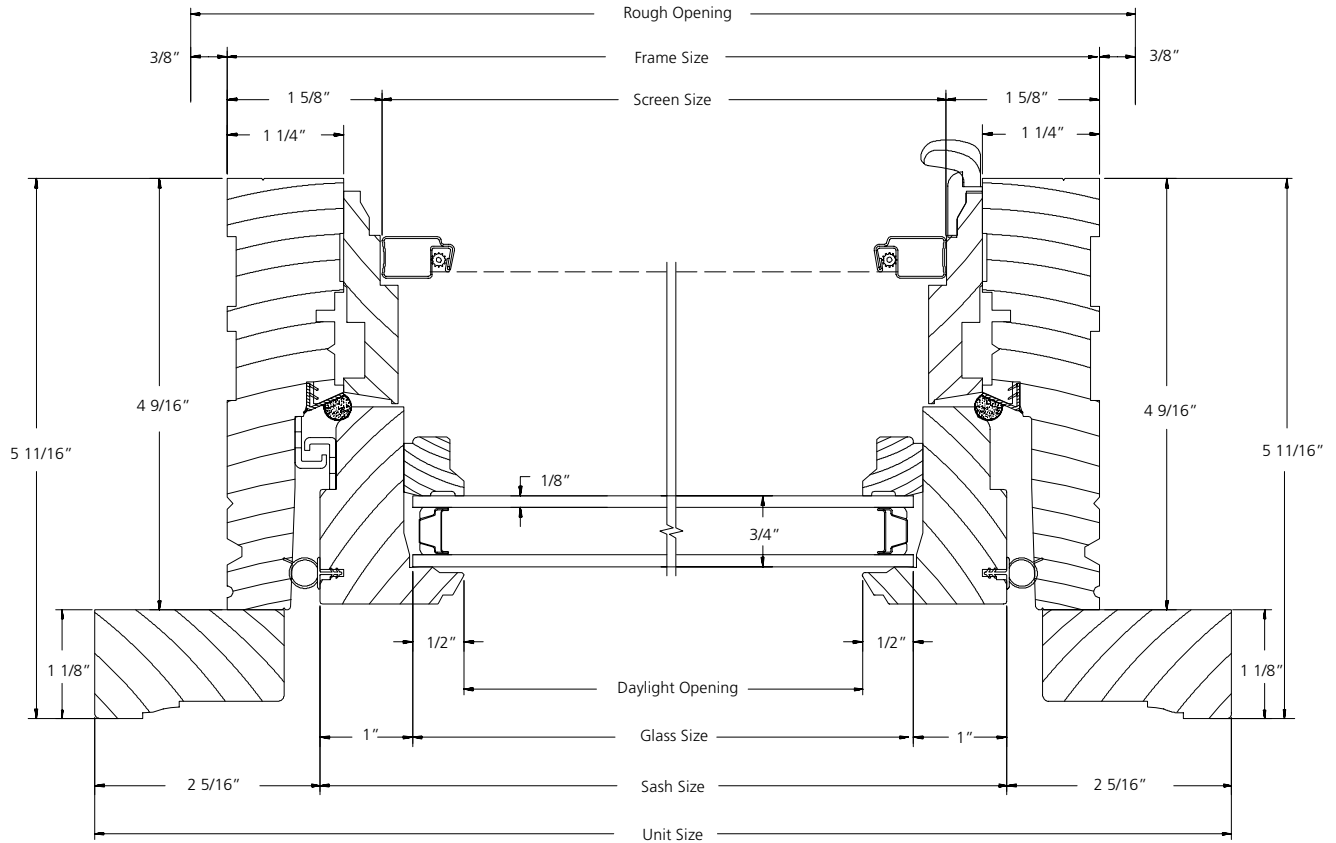

HORIZONTAL SECTION

SCALE: 6" = 1'

PICTURE UNIT

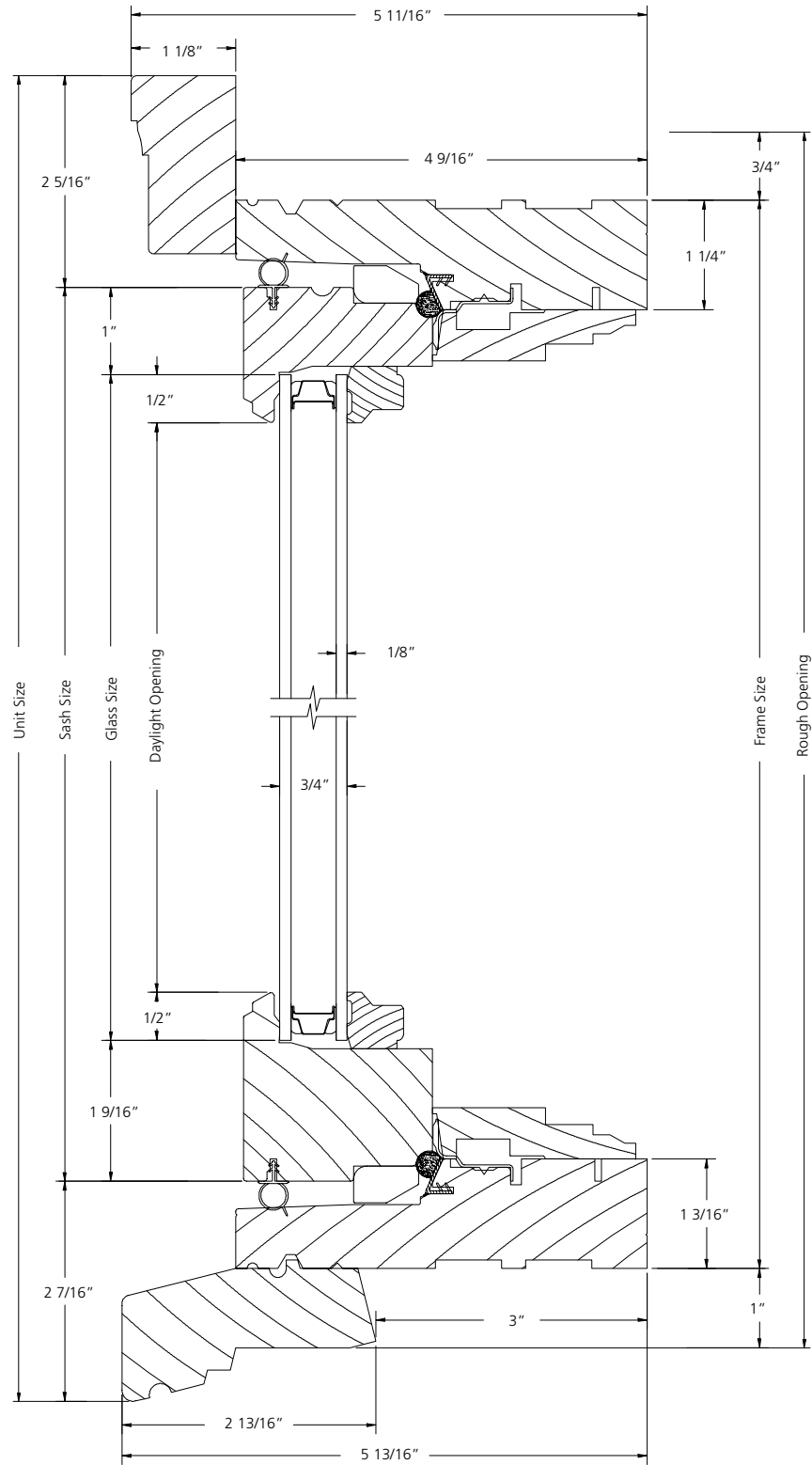

VERTICAL SECTION

SCALE: 6" = 1'

PICTURE UNIT

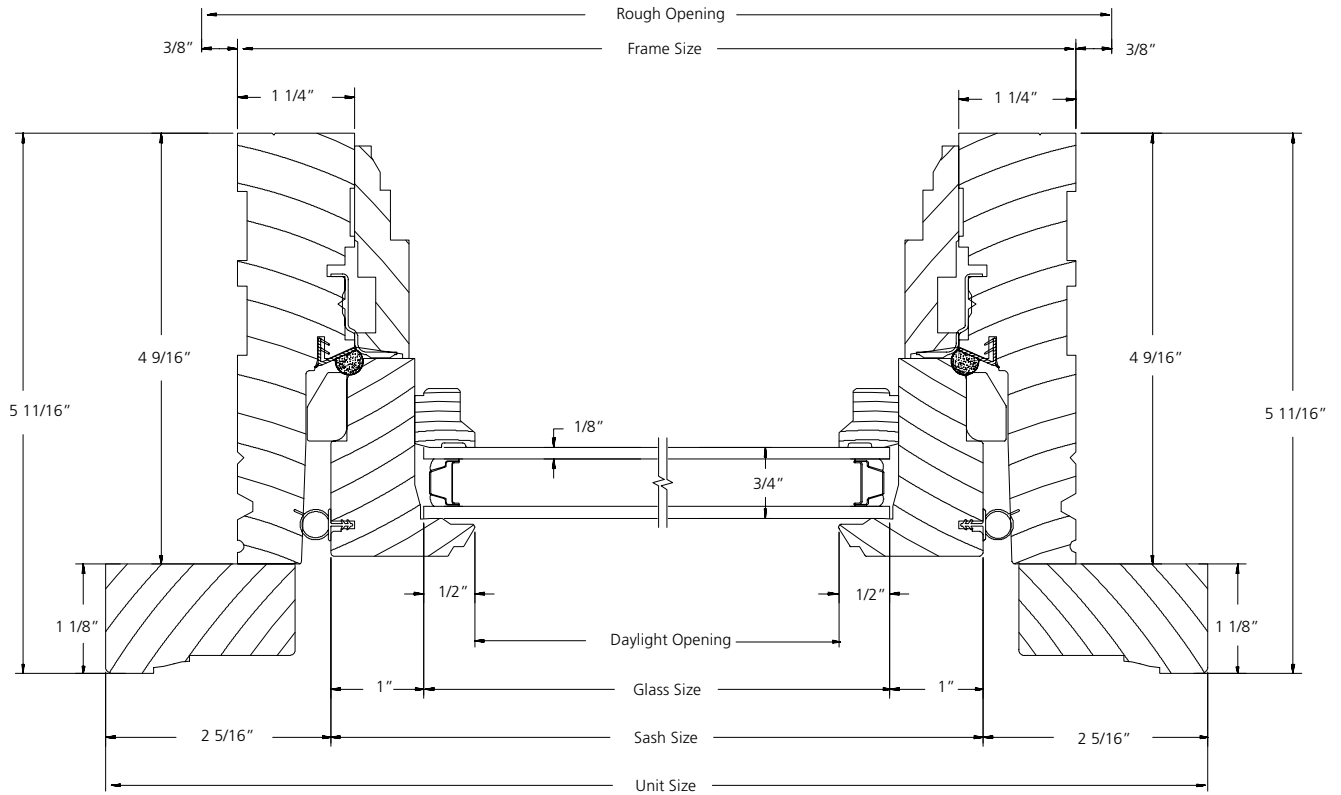

HORIZONTAL SECTION

SCALE: 6" = 1'

SECTOR TOP UNIT 1-WIDE

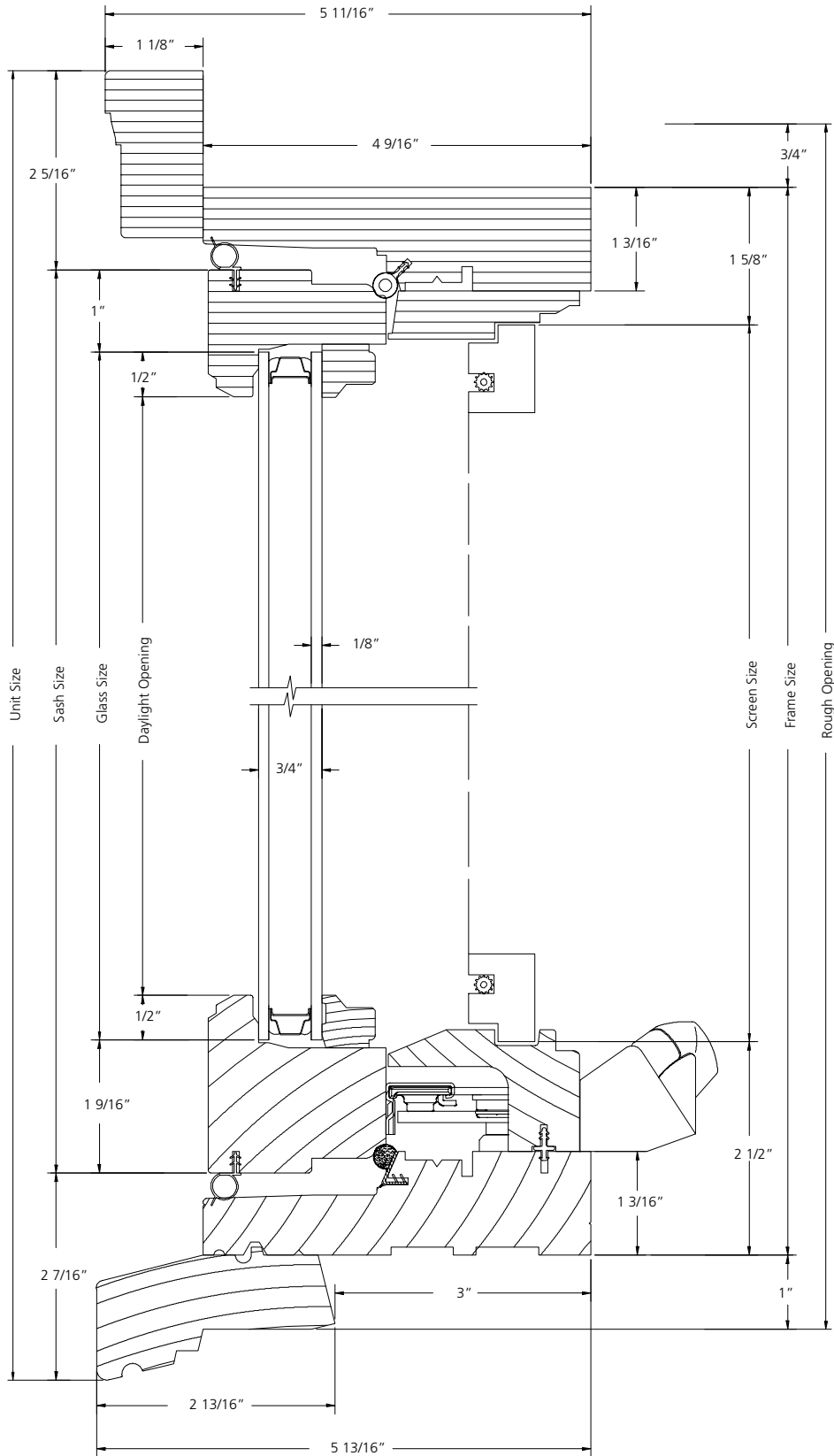

VERTICAL SECTION

SCALE: 6" = 1'

SECTOR TOP UNIT 1-WIDE

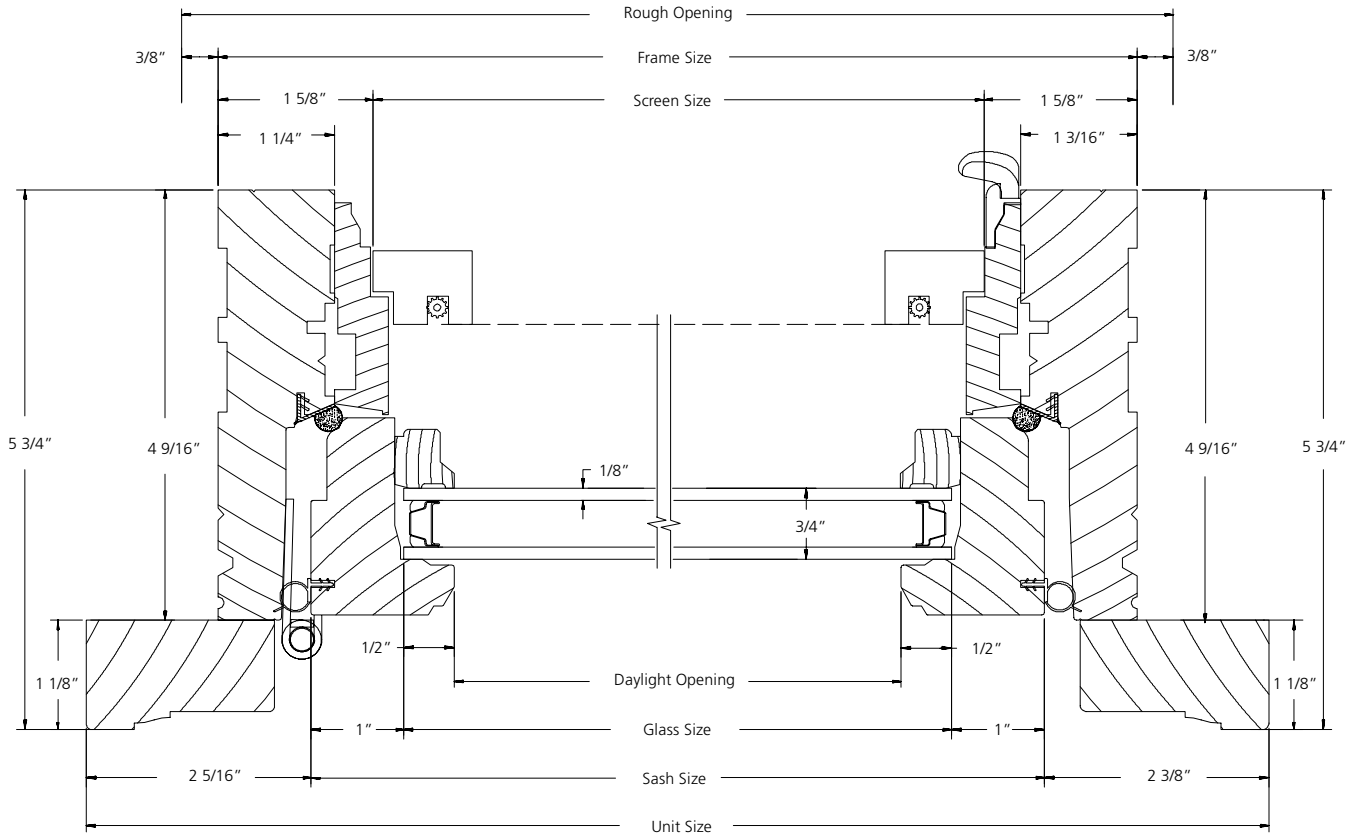

HORIZONTAL SECTION

SCALE: 6" = 1'

SECTOR TOP UNIT 2-WIDE

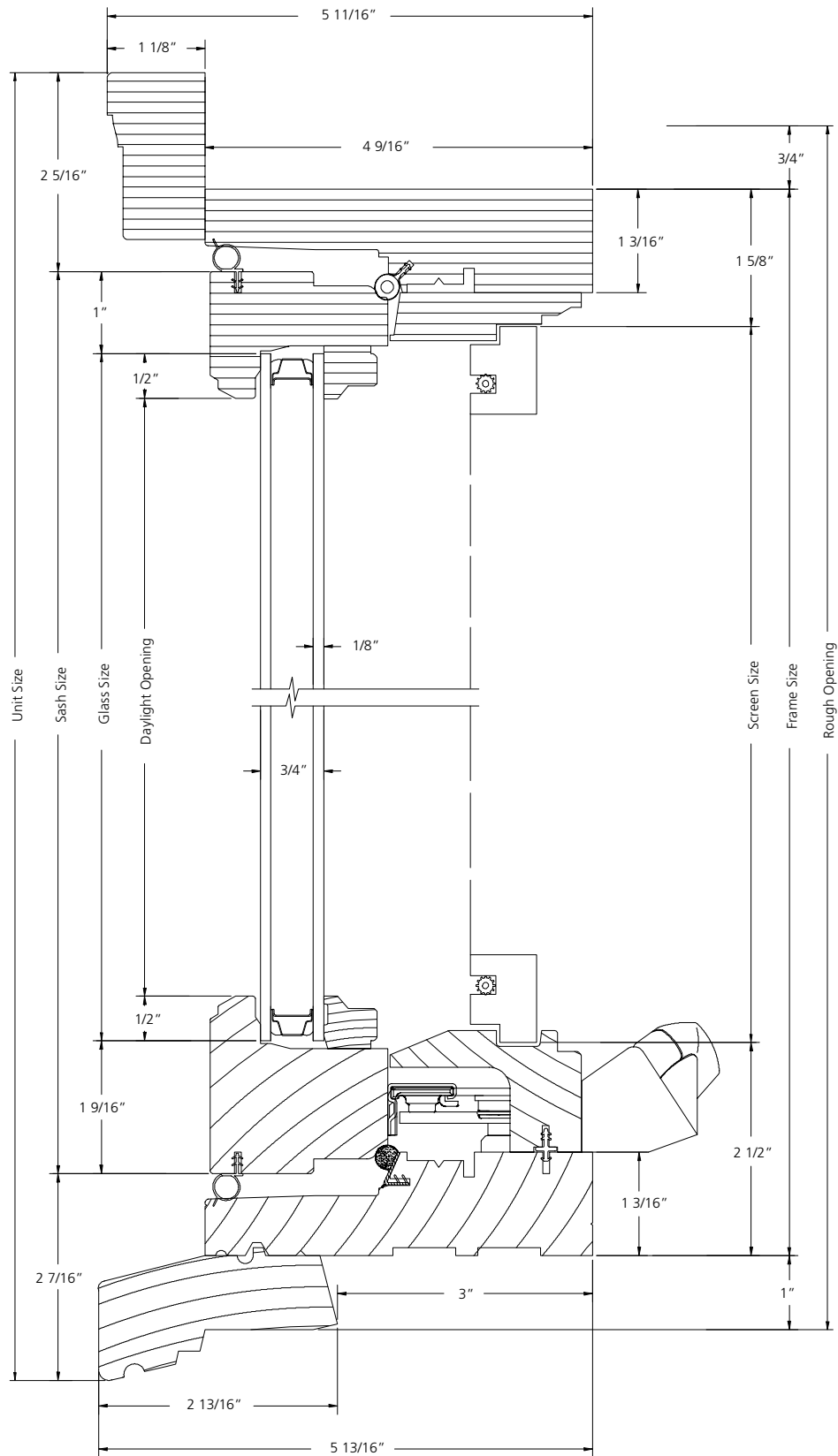

VERTICAL SECTION

SCALE: 6" = 1'

SECTOR TOP UNIT 2-WIDE

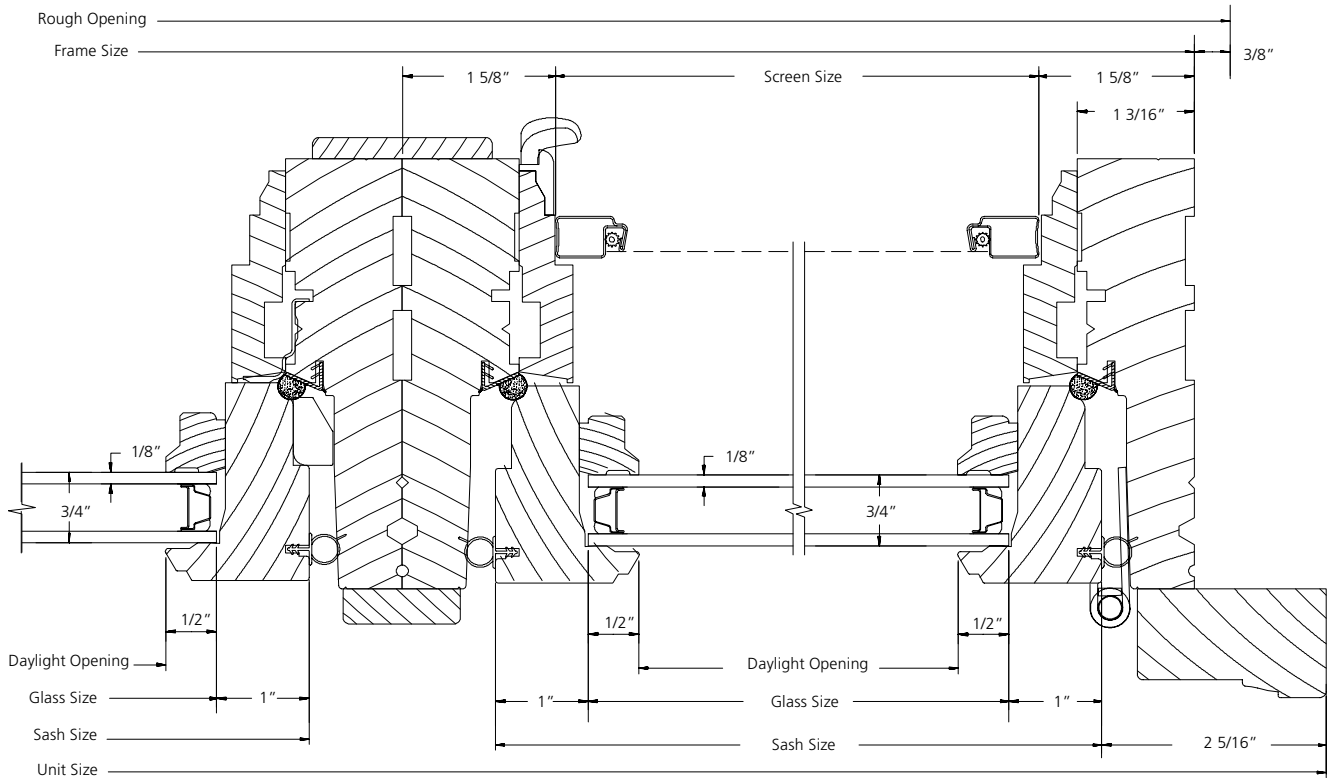
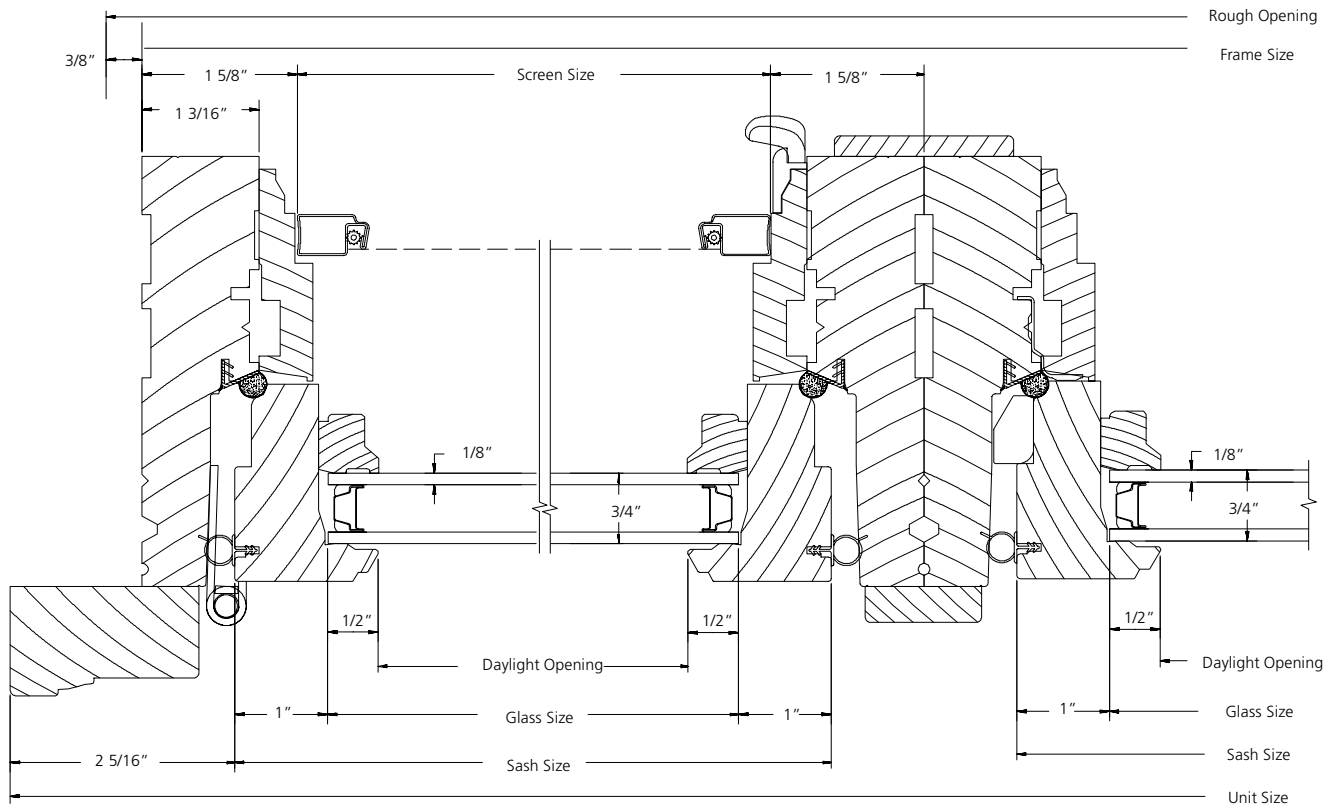

HORIZONTAL SECTION

SCALE: 6" = 1'

SECTOR TOP UNIT 3-WIDE

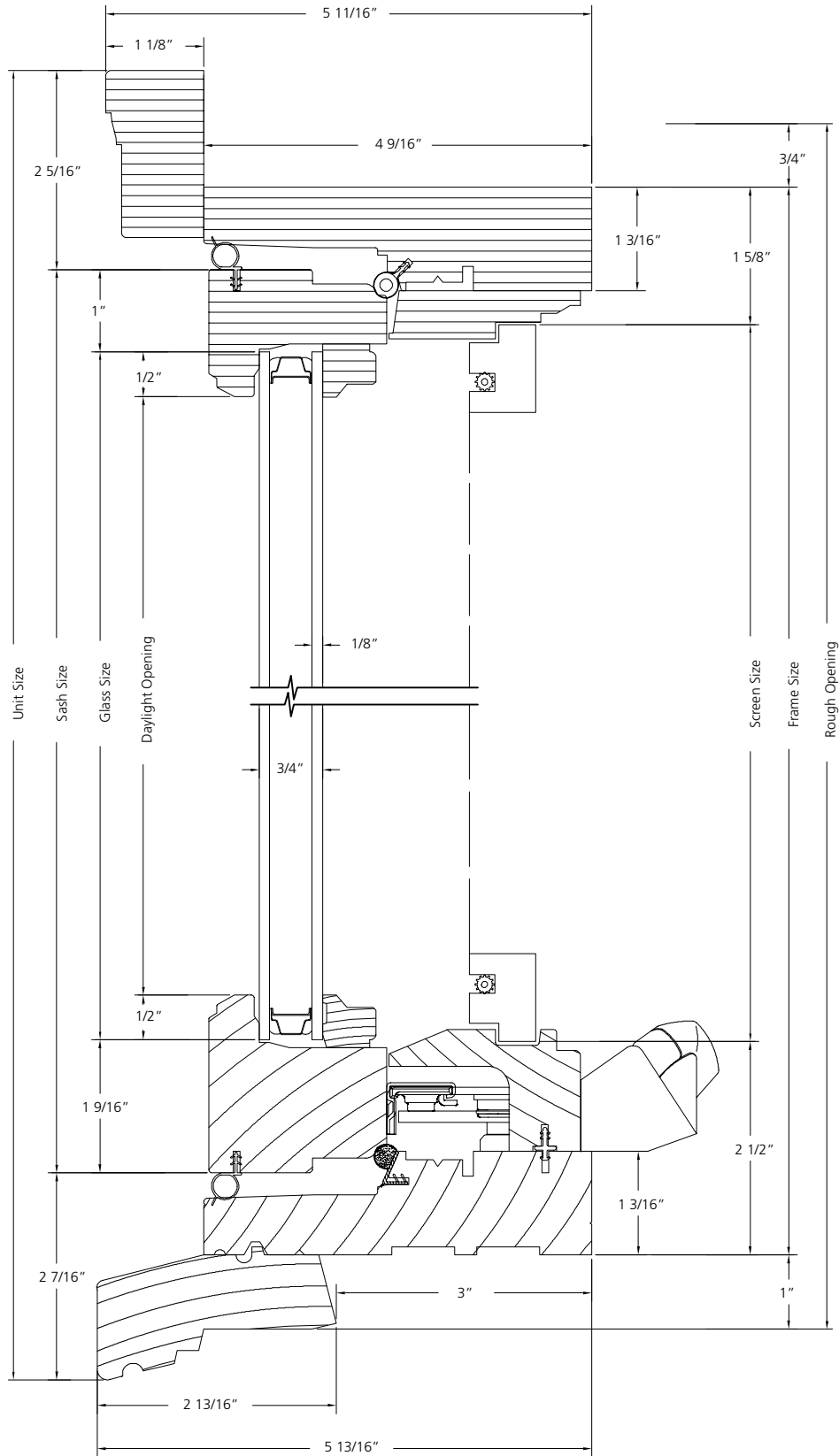

VERTICAL SECTION

SCALE: 6" = 1'

SECTOR TOP UNIT 3-WIDE

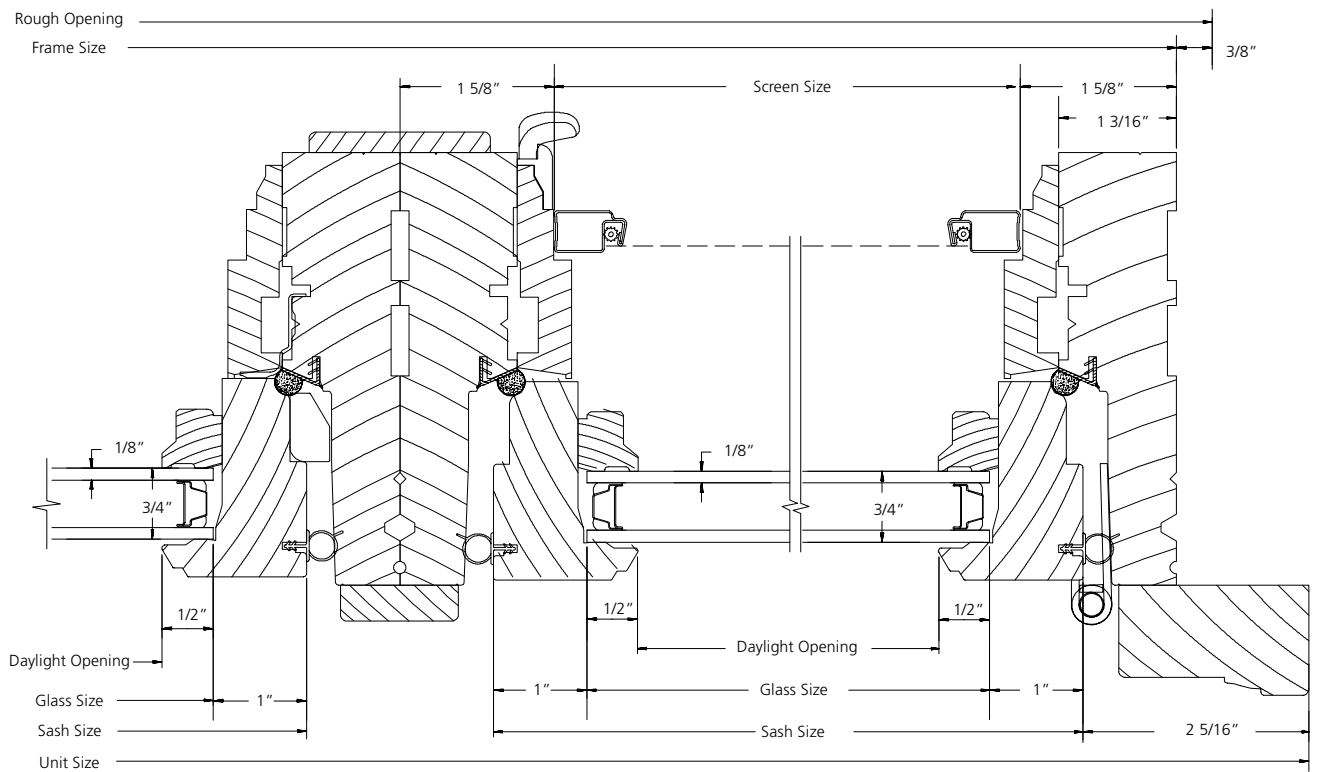
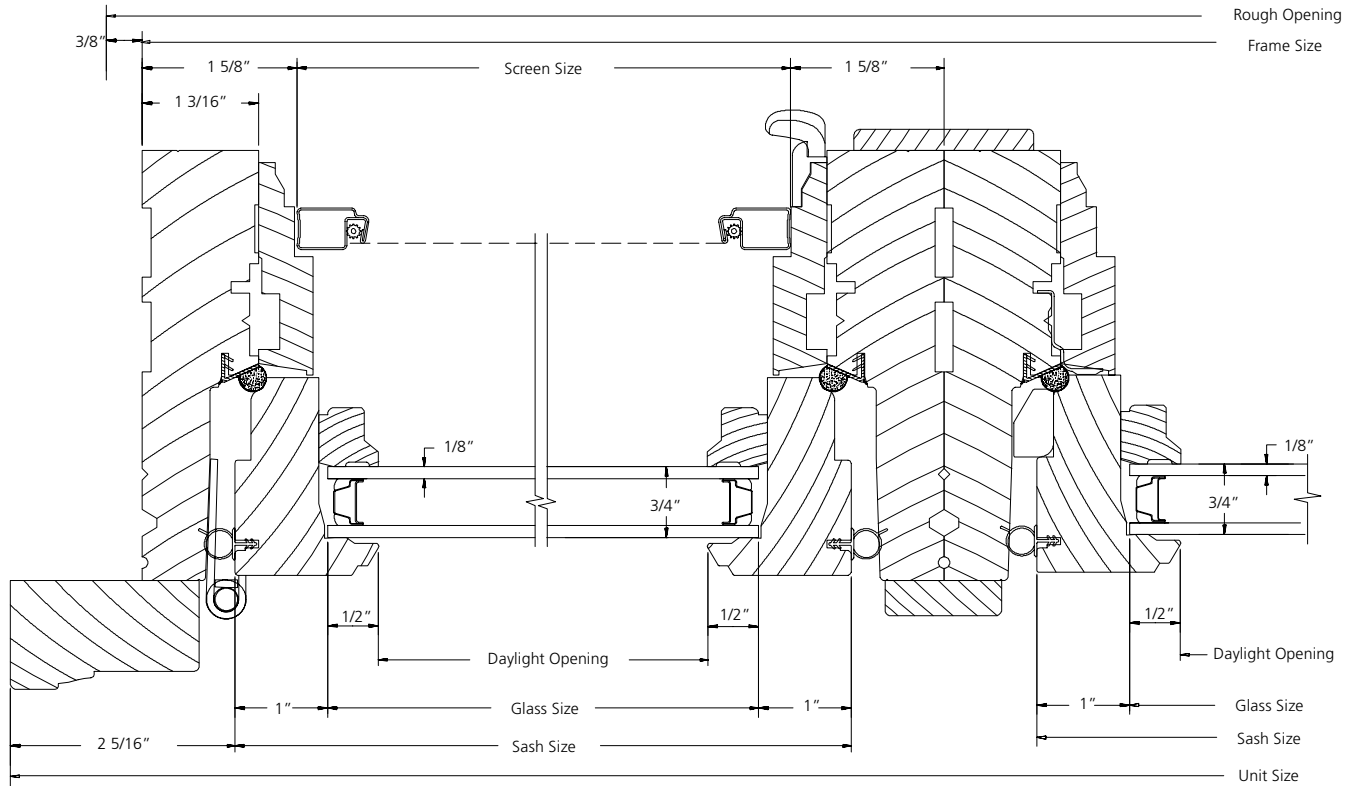

HORIZONTAL SECTION

SCALE: 6" = 1'

FRENCH CASEMENT UNIT

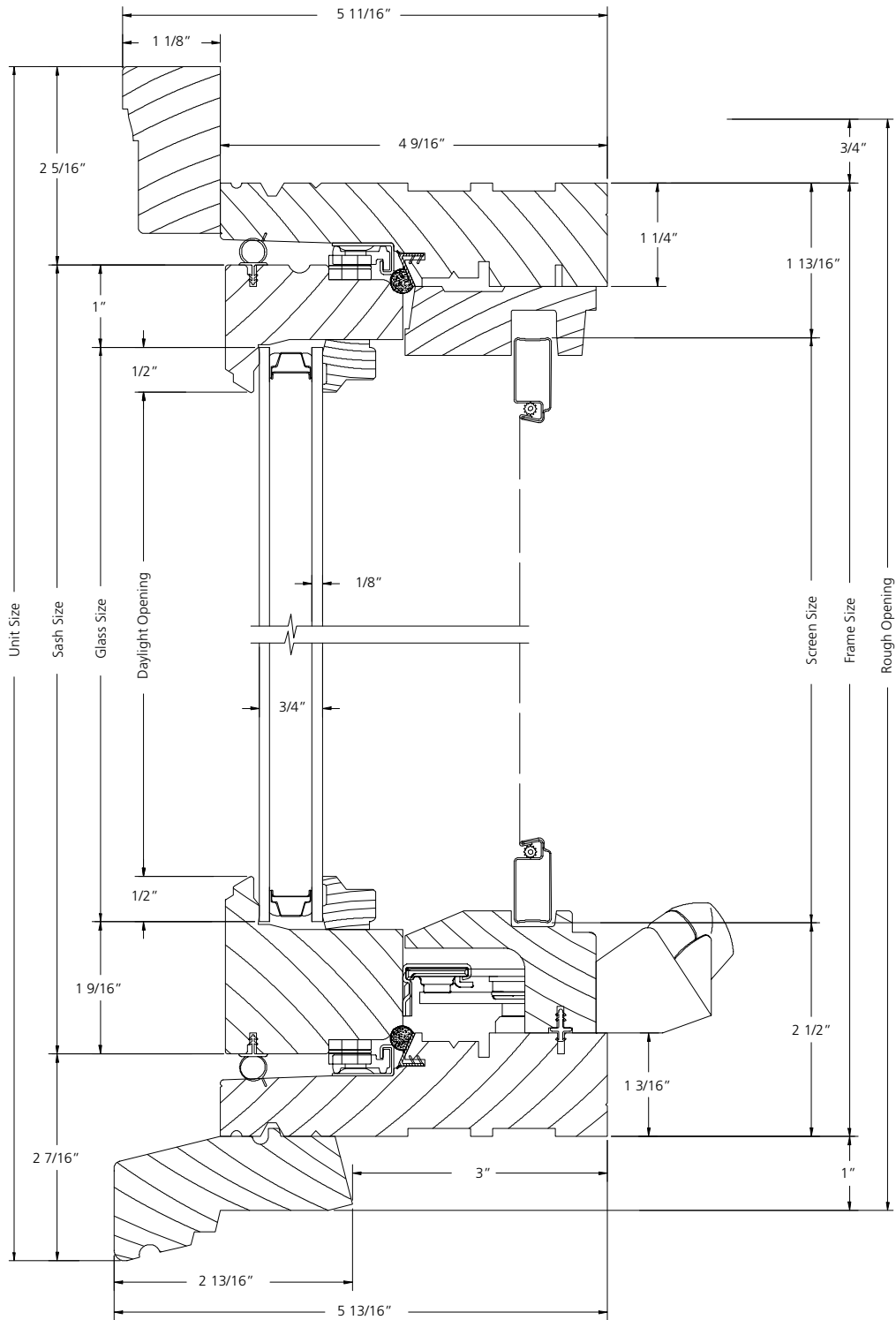

VERTICAL SECTION

SCALE: 6" = 1'

FRENCH CASEMENT UNIT

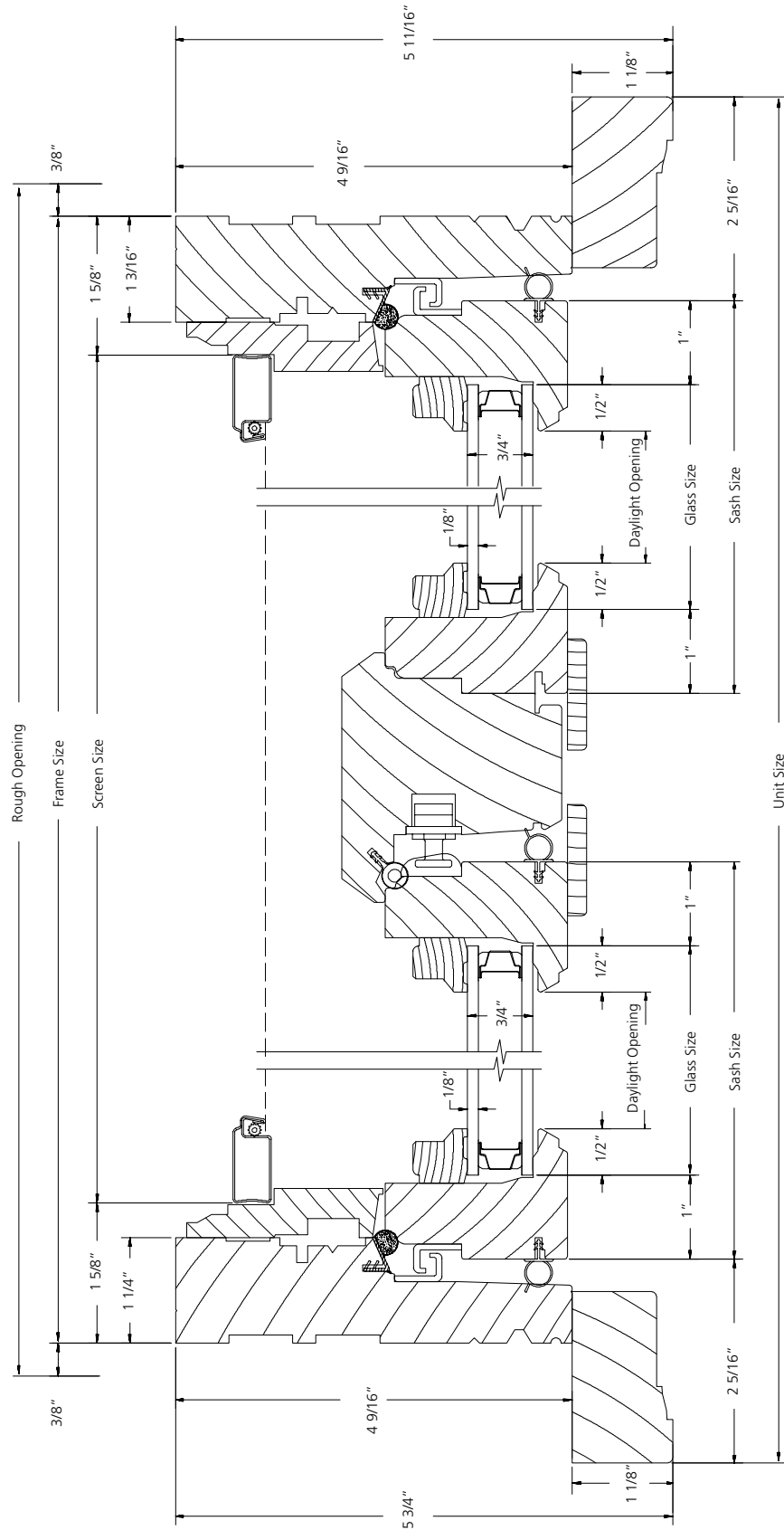

HORIZONTAL SECTION

SCALE: 6" = 1'

FRENCH PICTURE UNIT

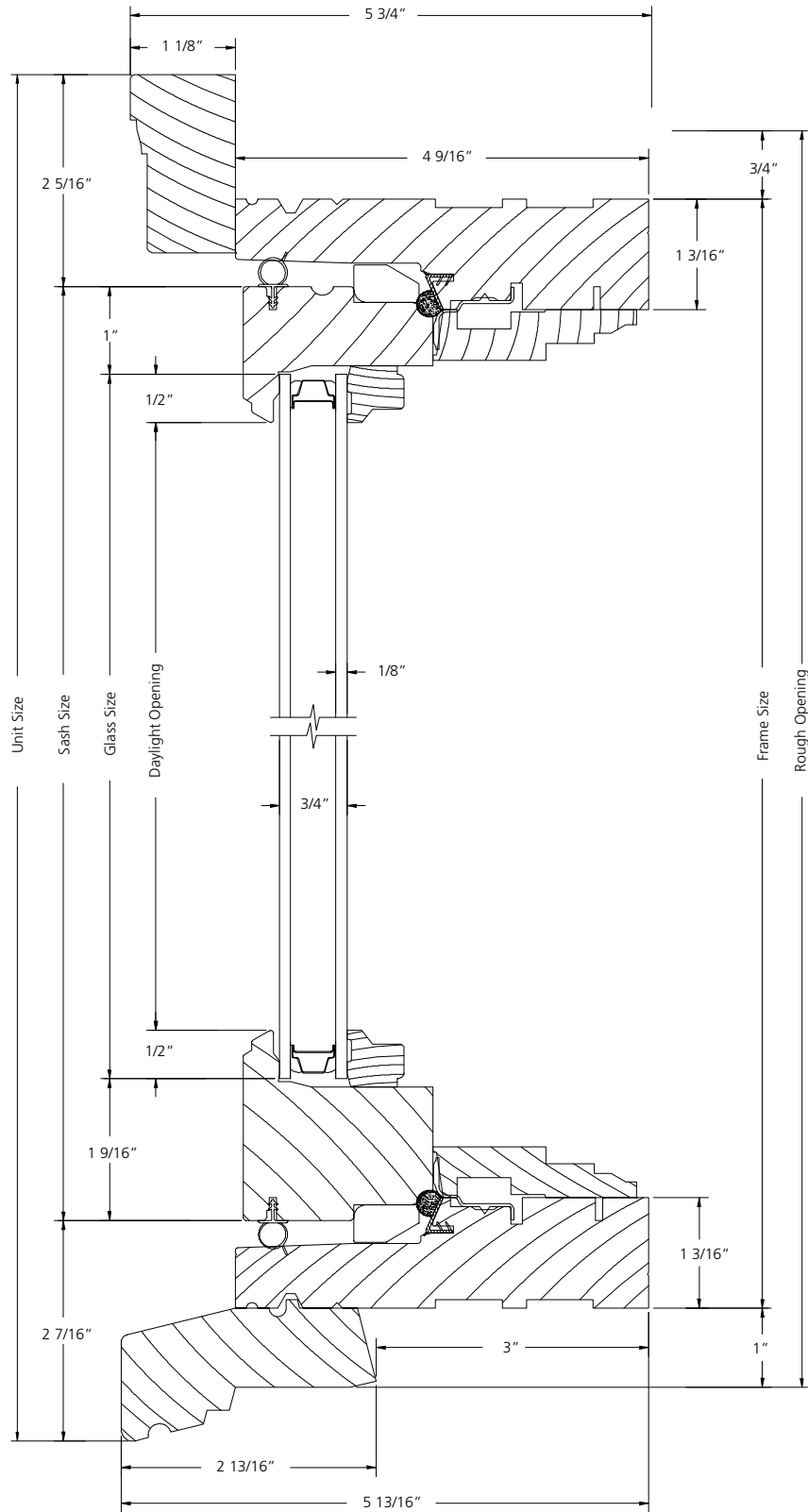

VERTICAL SECTION

SCALE: 6" = 1'

FRENCH PICTURE UNIT

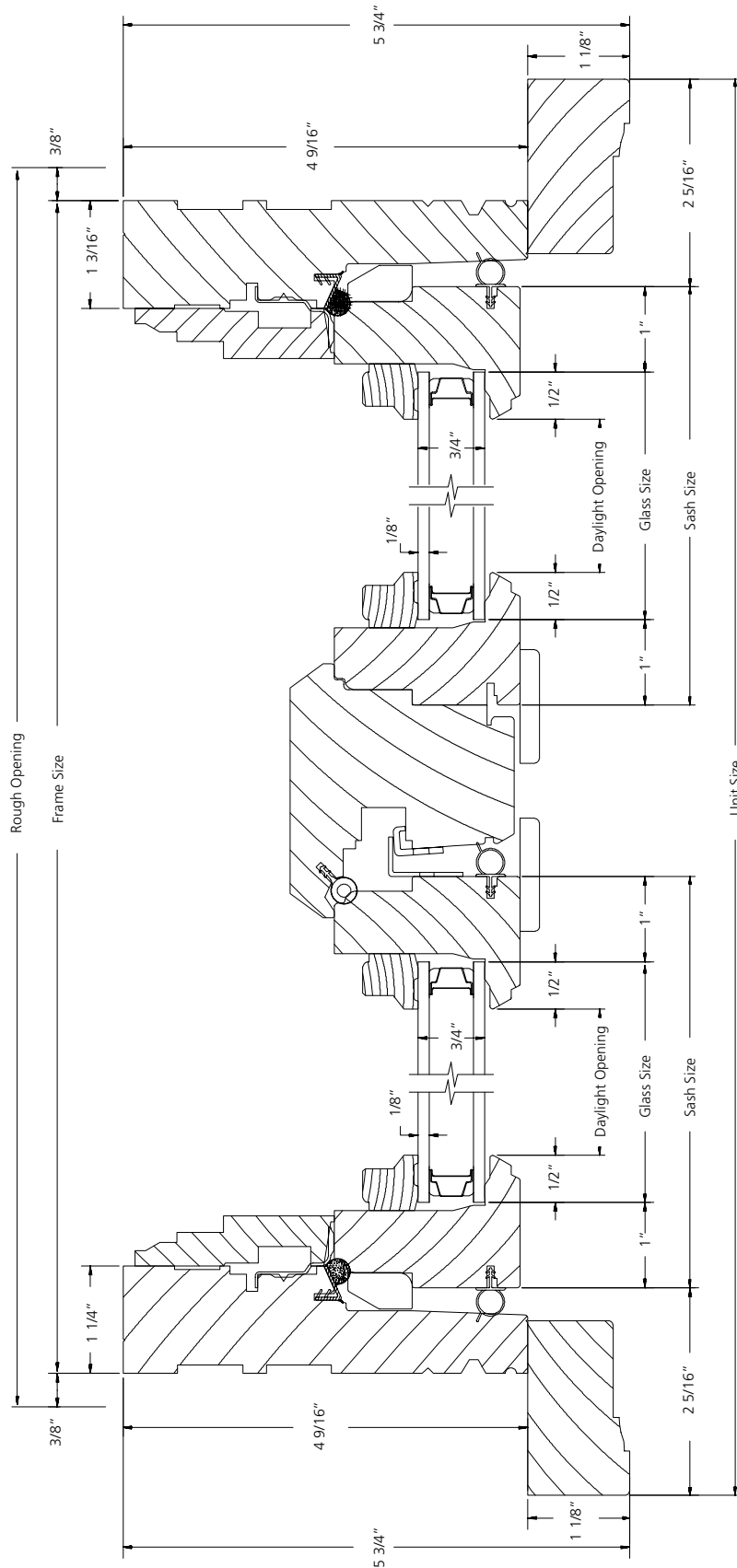

HORIZONTAL SECTION

SCALE: 6" = 1'

FRENCH SECTOR TOP CASEMENT UNIT

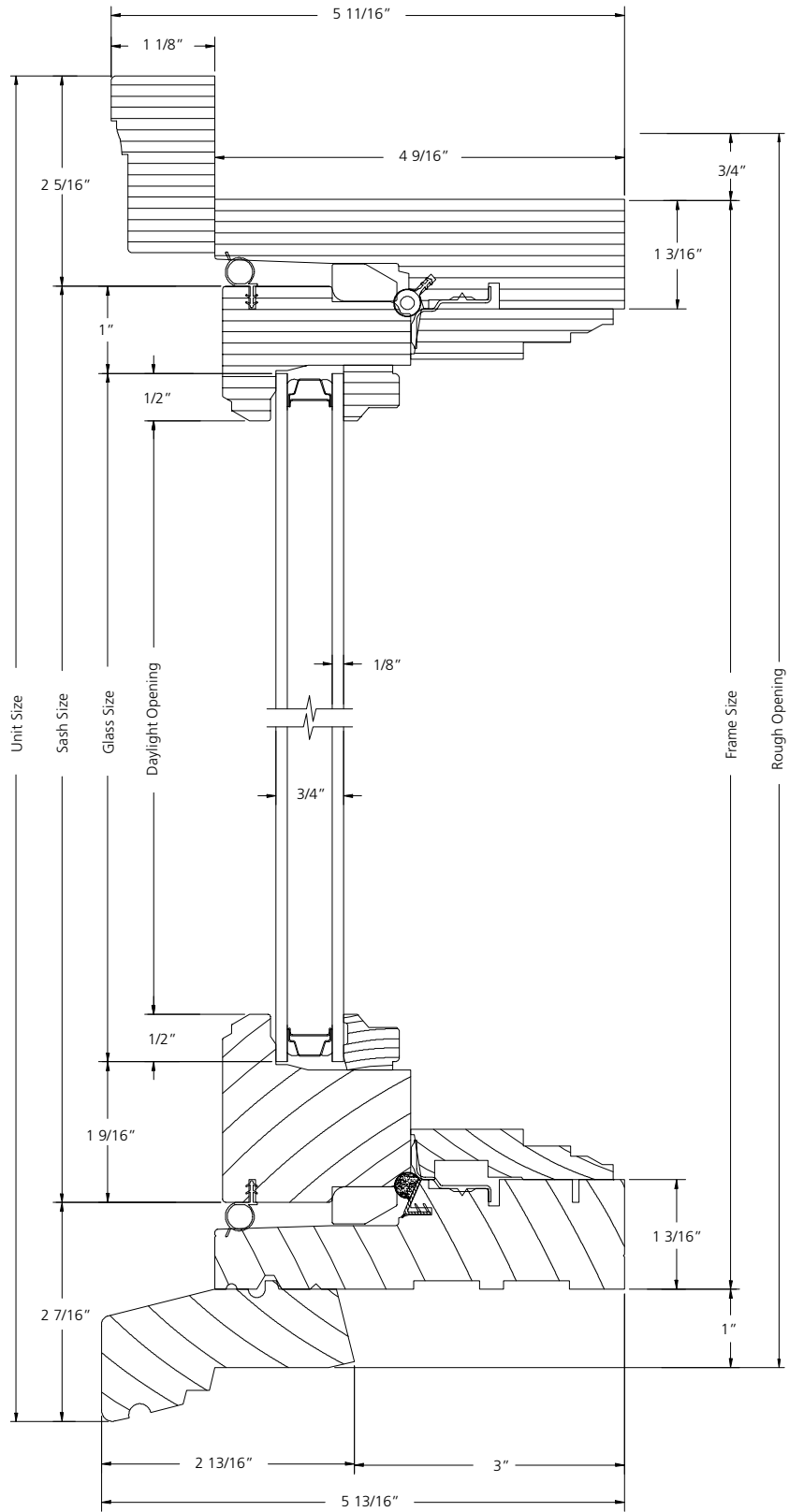

VERTICAL SECTION

SCALE: 6" = 1'

FRENCH SECTOR TOP CASEMENT UNIT

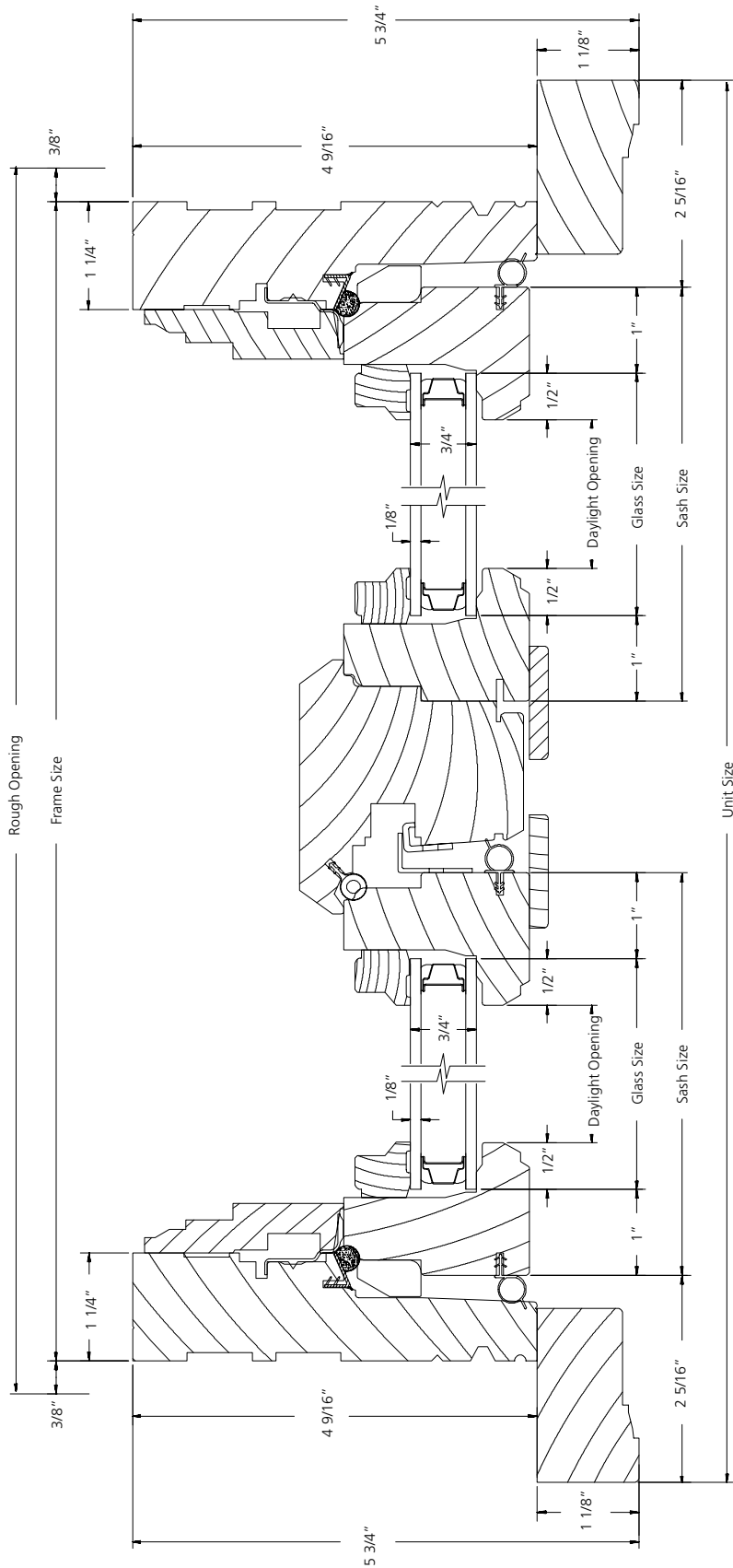

HORIZONTAL SECTION

SCALE: 6" = 1'

FRENCH HALF ROUND TOP CASEMENT UNIT

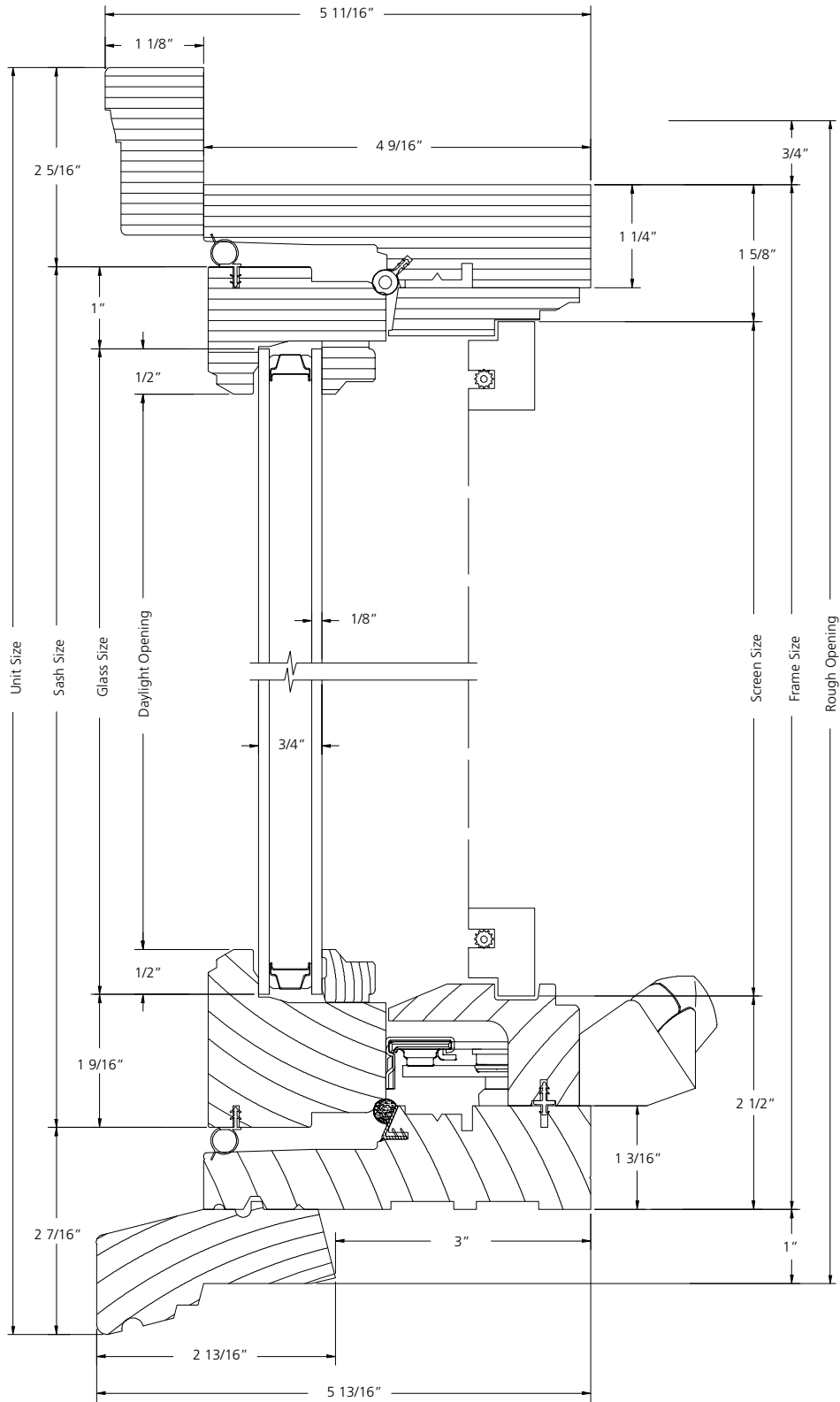

VERTICAL SECTION

SCALE: 6" = 1'

FRENCH HALF ROUND TOP CASEMENT UNIT

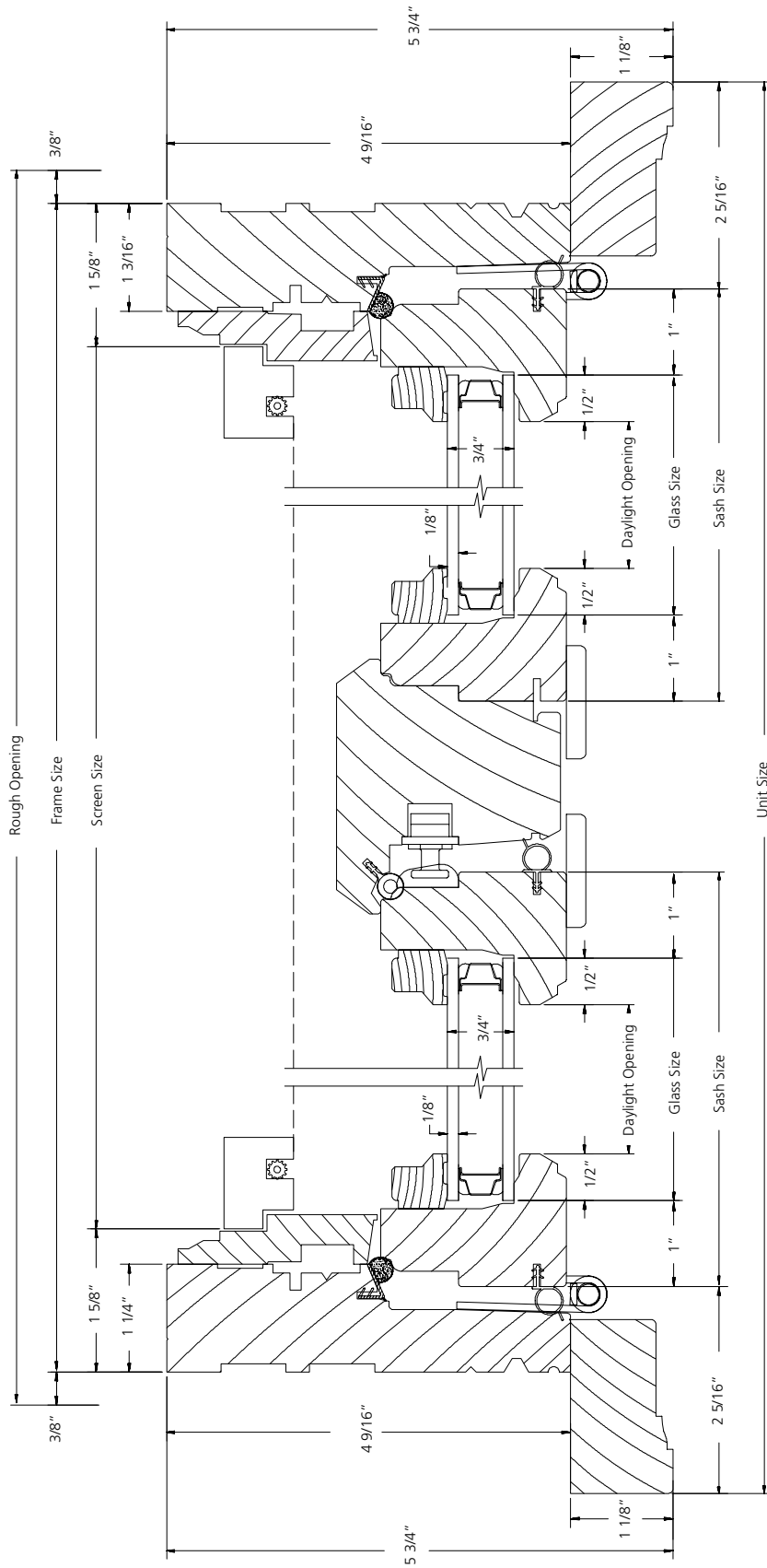

HORIZONTAL SECTION

SCALE: 6" = 1'

EXTENDED HALF ROUND UNIT

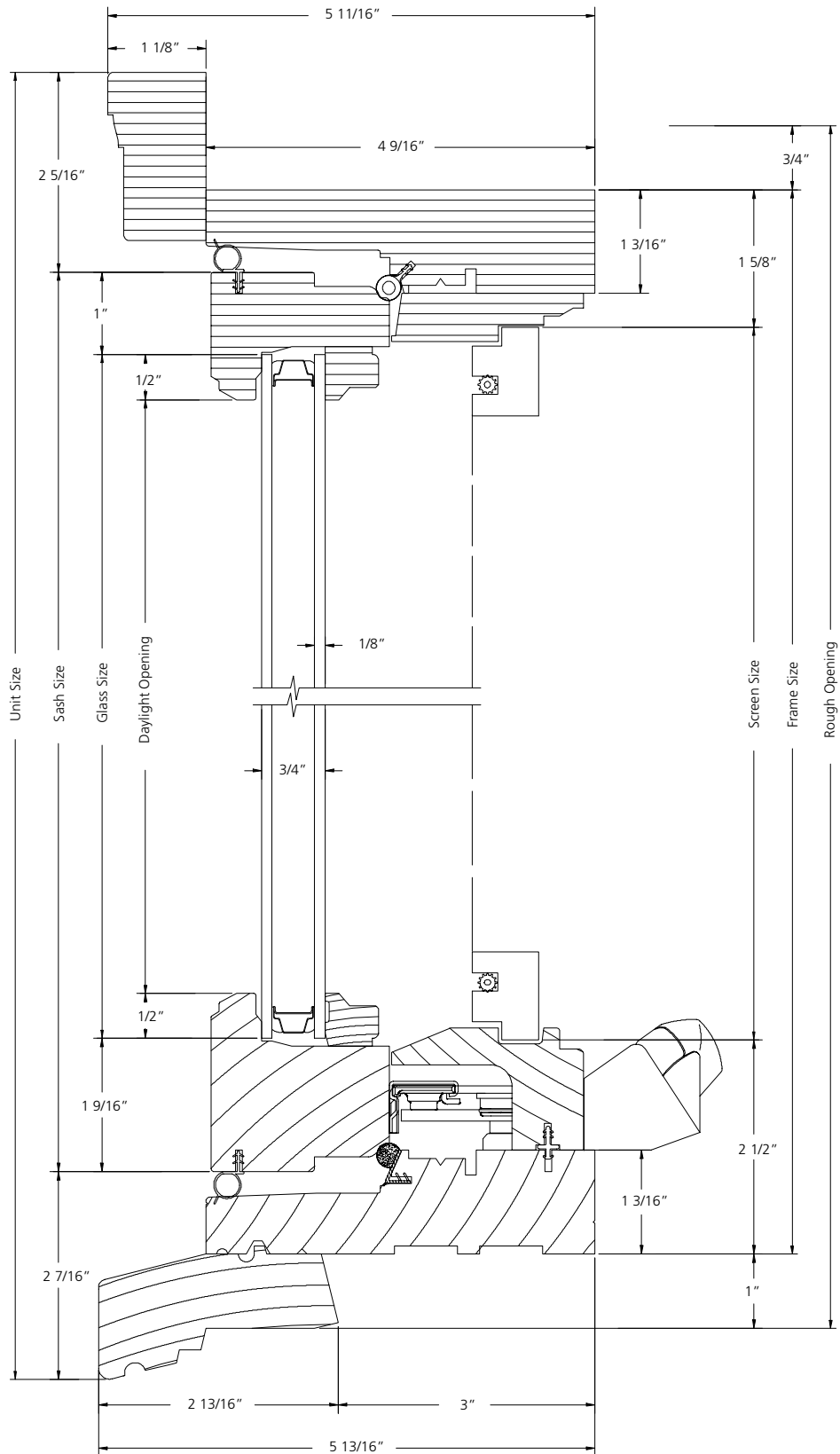

VERTICAL SECTION

SCALE: 6" = 1'

EXTENDED HALF ROUND UNIT

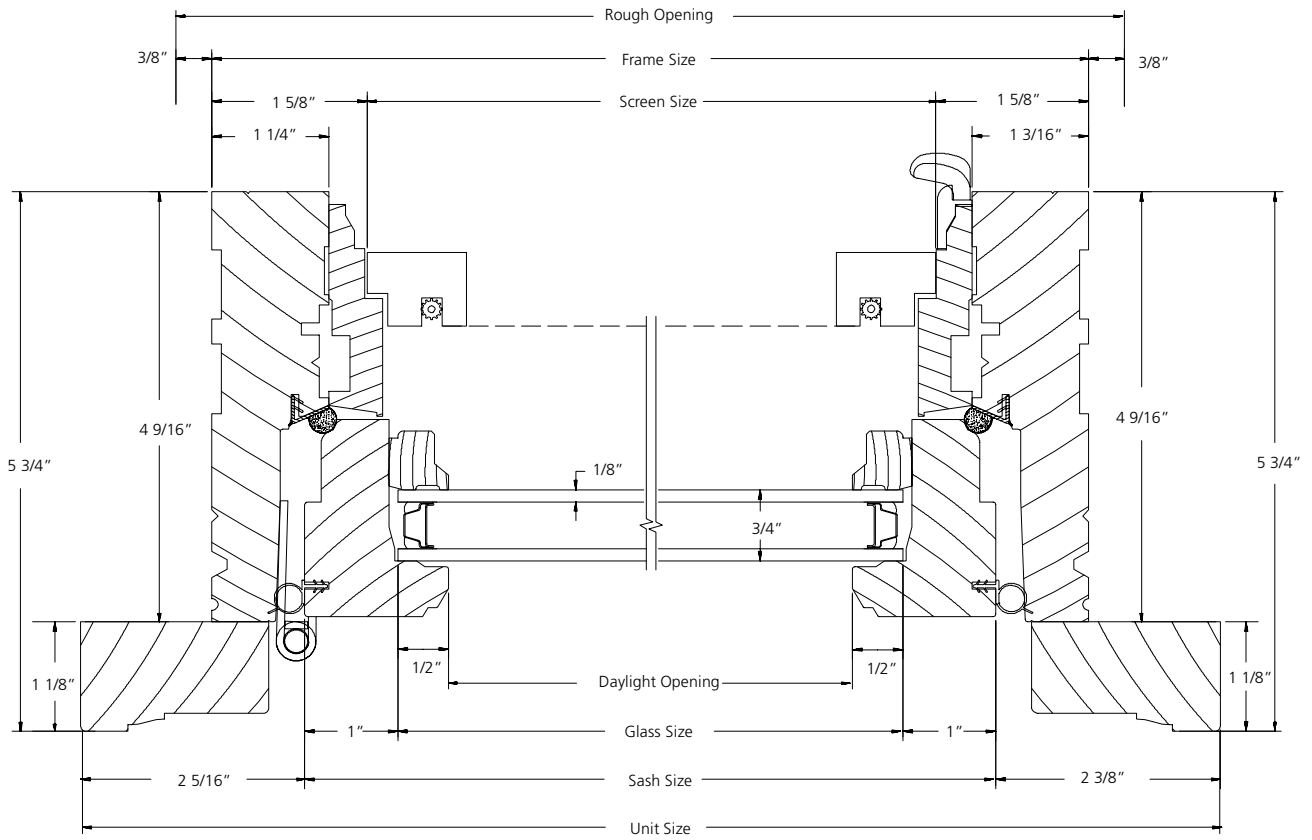

HORIZONTAL SECTION

SCALE: 6" = 1'

EXTENDED QUARTER ROUND UNIT

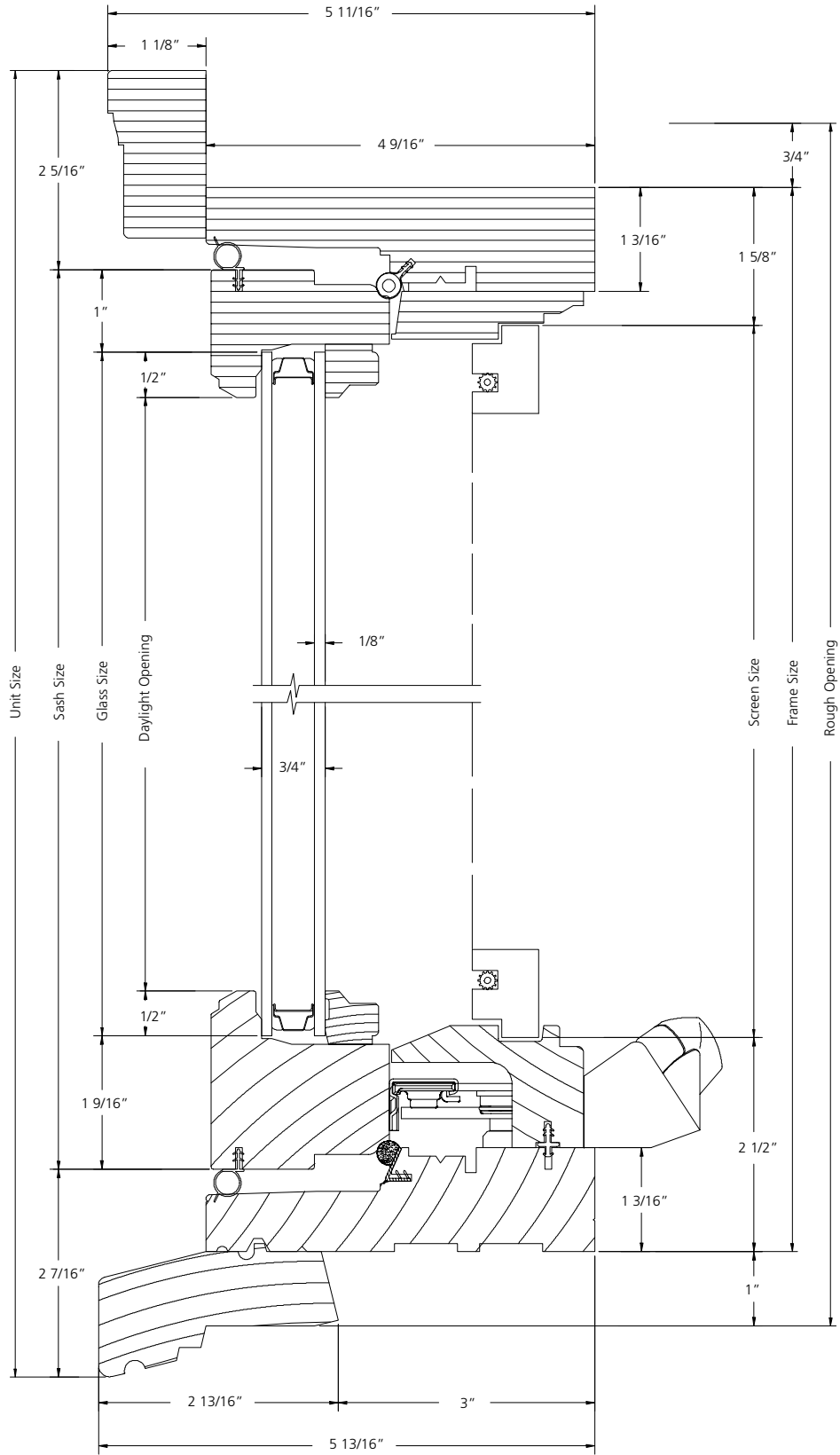

VERTICAL SECTION

SCALE: 6" = 1'

EXTENDED QUARTER ROUND UNIT

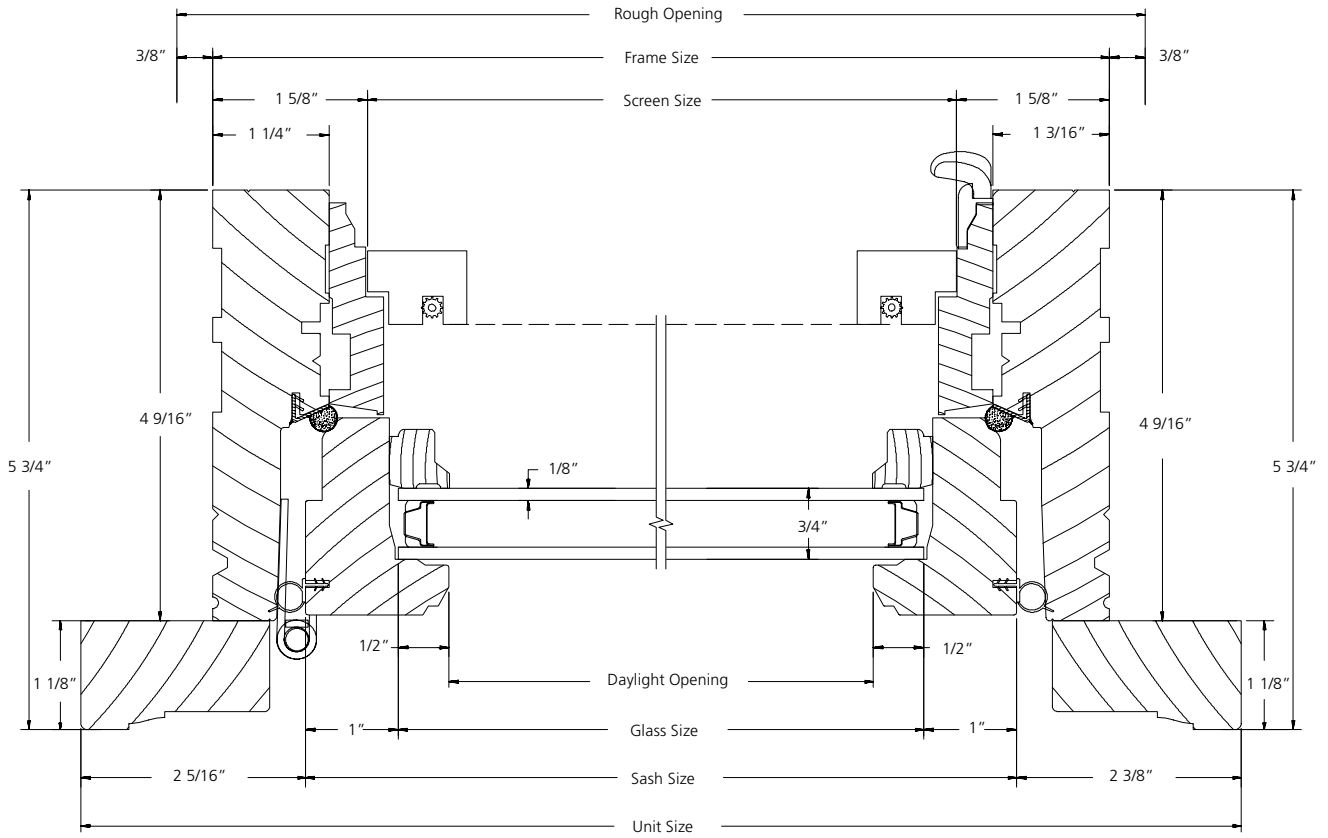

HORIZONTAL SECTION

SCALE: 6" = 1'

BAY WINDOW HORIZONTAL SPECIFICATION TABLES

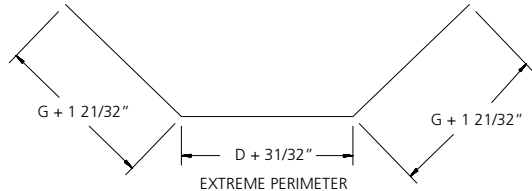
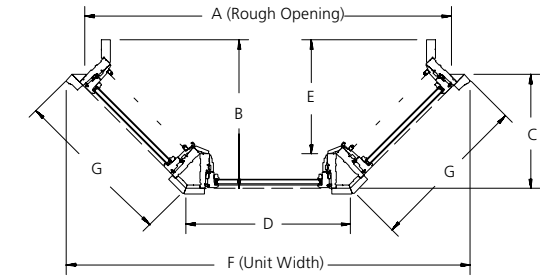
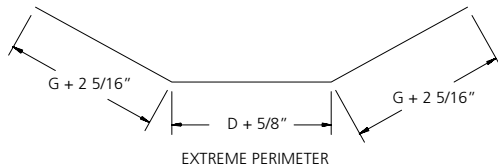
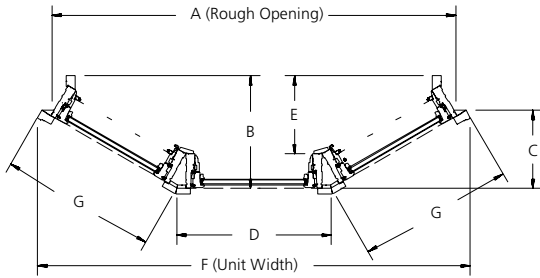

EXTREME PERIMETER
Extreme Perimeter is the distance around the face of the bay, beginning at the exterior sheathing and continuing around the assembly along the extreme face of the brickmould.

BOOKCODE NOTE:

WCY183648-30

Labels: Flanker Frame Width, Center Frame Width, Frame Height, Degree of Bay Window

30° BAY									
Flanker Width	Center Width	A Rough Opening	F Unit Width	B Overall Projection*	C Projection Exterior Wall	E Seating Depth*	D Outside Mull To Mull	G Outside Mull To Unit	
18	18	53 3/4	57 9/32	14 1/16	10 5/16	10 5/16	20 7/16	20 19/32	
18	36	71 3/4	75 9/32	14 1/16	10 5/16	10 5/16	38 7/16	20 19/32	
18	42	77 3/4	81 9/32	14 1/16	10 5/16	10 5/16	44 7/16	20 19/32	
18	48	83 3/4	87 9/32	14 1/16	10 5/16	10 5/16	50 7/16	20 19/32	
18	60	95 3/4	99 9/32	14 1/16	10 5/16	10 5/16	62 7/16	20 19/32	
18	72	107 3/4	111 9/32	14 1/16	10 5/16	10 5/16	74 7/16	20 19/32	

45° BAY									
Flanker Width	Center Width	A Rough Opening	F Unit Width	B Overall Projection*	C Projection Exterior Wall	E Seating Depth*	D Outside Mull To Mull	G Outside Mull To Unit	
18	18	48 3/4	53 1/2	19 5/8	15 1/16	15 1/16	21 25/32	21 9/32	
18	36	66 3/4	71 1/2	19 5/8	15 1/16	15 1/16	39 25/32	21 9/32	
18	42	72 3/4	77 1/2	19 5/8	15 1/16	15 1/16	45 25/32	21 9/32	
18	48	78 3/4	83 1/2	19 5/8	15 1/16	15 1/16	51 25/32	21 9/32	
18	60	90 3/4	95 1/2	19 5/8	15 1/16	15 1/16	63 25/32	21 9/32	
18	72	102 3/4	107 1/2	19 5/8	15 1/16	15 1/16	75 25/32	21 9/32	

24	24	70 1/8	73 11/16	17 1/16	13 5/16	13 5/16	26 7/16	26 19/32	
24	36	82 1/8	85 11/16	17 1/16	13 5/16	13 5/16	38 7/16	26 19/32	
24	42	88 1/8	91 11/16	17 1/16	13 5/16	13 5/16	44 7/16	26 19/32	
24	48	94 1/8	97 11/16	17 1/16	13 5/16	13 5/16	50 7/16	26 19/32	
24	60	106 1/8	109 11/16	17 1/16	13 5/16	13 5/16	62 7/16	26 19/32	
24	72	118 1/8	121 11/16	17 1/16	13 5/16	13 5/16	74 7/16	26 19/32	

24	24	63 1/4	68	23 1/16	19 5/16	19 5/16	27 25/32	27 9/32	
24	36	75 1/4	80	23 1/16	19 5/16	19 5/16	39 25/32	27 9/32	
24	42	81 1/4	86	23 1/16	19 5/16	19 5/16	45 25/32	27 9/32	
24	48	87 1/4	92	23 1/16	19 5/16	19 5/16	51 25/32	27 9/32	
24	60	99 1/4	104	23 1/16	19 5/16	19 5/16	63 25/32	27 9/32	
24	72	111 1/4	116	23 1/16	19 5/16	19 5/16	75 25/32	27 9/32	

28	28	81 1/16	84 19/32	19 1/16	15 5/16	15 5/16	30 7/16	30 19/32	
28	36	89 1/16	92 19/32	19 1/16	15 5/16	15 5/16	38 7/16	30 19/32	
28	42	95 1/16	98 19/32	19 1/16	15 5/16	15 5/16	44 7/16	30 19/32	
28	48	101 1/16	104 19/32	19 1/16	15 5/16	15 5/16	50 7/16	30 19/32	
28	60	113 1/16	116 19/32	19 1/16	15 5/16	15 5/16	62 7/16	30 19/32	
28	72	125 1/16	128 19/32	19 1/16	15 5/16	15 5/16	74 7/16	30 19/32	

28	28	72 7/8	77 21/32	26 11/16	22 1/8	22 1/8	31 25/32	31 9/32	
28	36	80 7/8	85 21/32	26 11/16	22 1/8	22 1/8	39 25/32	31 9/32	
28	42	86 7/8	91 21/32	26 11/16	22 1/8	22 1/8	45 25/32	31 9/32	
28	48	92 7/8	97 21/32	26 11/16	22 1/8	22 1/8	51 25/32	31 9/32	
28	60	104 7/8	109 21/32	26 11/16	22 1/8	22 1/8	63 25/32	31 9/32	
28	72	116 7/8	121 21/32	26 11/16	22 1/8	22 1/8	75 25/32	31 9/32	

4 9/16 and 6 9/16 WALL APPLICATION

The tables above reflect a 4 9/16" wall application. To convert to 6 9/16" wall application add 2" to the figures in the columns which show an asterisk (*), B and E.

BOW WINDOW HORIZONTAL SPECIFICATION TABLES

BOW WINDOW HORIZONTAL SPECIFICATION TABLES

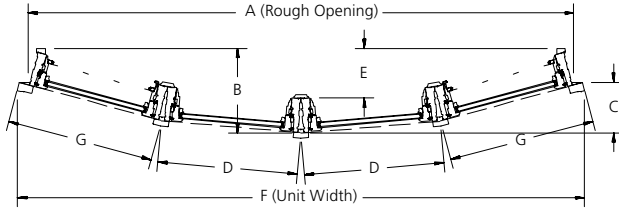

EXTREME PERIMETER
Extreme Perimeter is the distance around the face of the bow, beginning at the exterior sheathing and continuing around the extreme assembly along the extreme face of the brickmould.

4 WIDE BOW									
Flanker Width	A Rough Opening	F Unit Width	B Overall * Projection	C Projection Exterior Wall	E Seating * Depth	D Outside Mull To Mull	G Outside Mull To Unit	R Radius	
18	73 9/16	76 15/64	11 21/64	6 49/64	6 49/64	18 13/16	19 25/32	107 15/16	
24	97 1/8	99 25/32	13 25/64	8 53/64	8 53/64	24 13/16	25 25/32	142 3/8	
28	112 13/16	115 15/32	14 25/32	10 7/32	10 7/32	28 13/16	29 25/32	165 5/16	

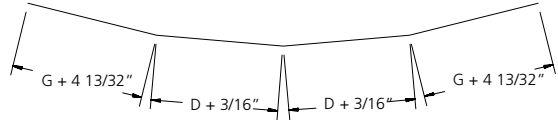

EXTREME PERIMETER

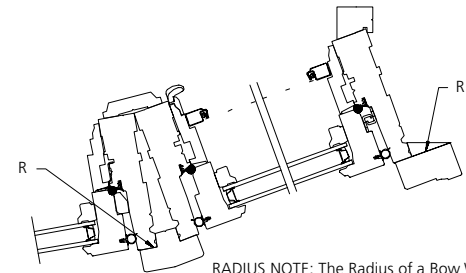
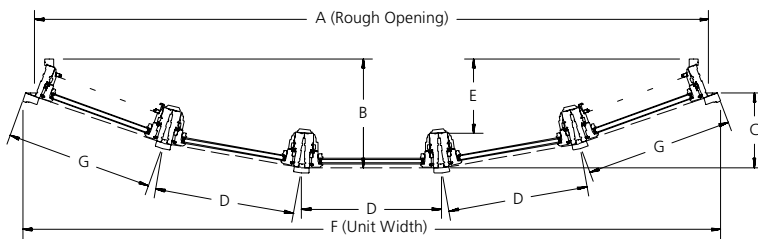

RADIUS NOTE: The Radius of a Bow Window is referenced from the interior of the Brickmould.

5 WIDE BOW									
Flanker Width	A Rough Opening	F Unit Width	B Overall * Projection	C Projection Exterior Wall	E Seating * Depth	D Outside Mull To Mull	G Outside Mull To Unit	R Radius	
18	90 7/8	93 25/32	14 19/32	10 1/32	10 1/32	18 13/16	19 25/32	107 15/16	
24	119 15/16	122 1/16	17 11/16	13 1/8	13 1/8	24 13/16	25 25/32	142 3/8	
28	139 5/16	142 17/64	19 3/4	15 3/16	15 3/16	28 13/16	29 25/32	165 5/16	

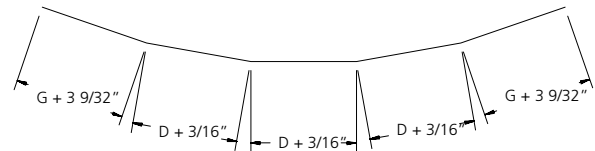

EXTREME PERIMETER

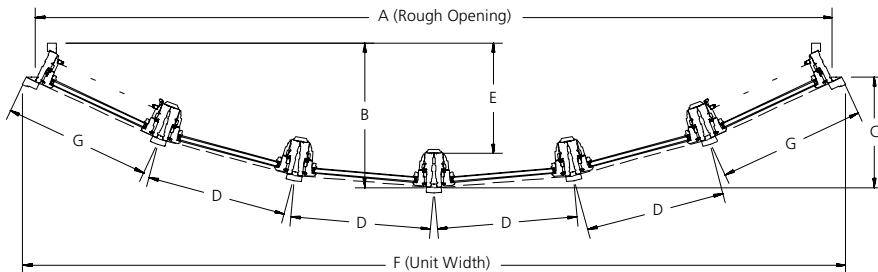

6 WIDE BOW									
Flanker Width	A Rough Opening	F Unit Width	B Overall * Projection	C Projection Exterior Wall	E Seating * Depth	D Outside Mull To Mull	G Outside Mull To Unit	R Radius	
18	107 3/8	110 39/64	19 27/64	14 55/64	14 55/64	18 13/16	19 25/32	107 15/16	
24	141 13/16	145 1/32	24 3/64	19 31/64	19 31/64	24 13/16	25 25/32	142 3/8	
28	164 3/4	167 31/32	27 7/64	22 35/64	22 35/64	28 13/16	29 25/32	165 5/16	

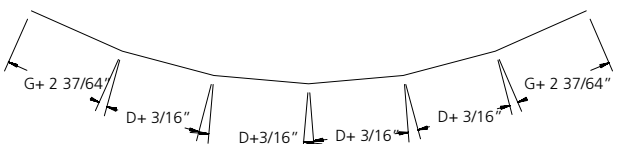

EXTREME PERIMETER

4 9/16 and 6 9/16 WALL APPLICATION
The tables above reflect a 4 9/16" wall application. To convert to 6 9/16" wall application add 2" to the figures in the columns which show an asterisk (*), B and E.

BAY & BOW WINDOW ROUGH OPENINGS

BAY & BOW WINDOW TRIM OPTIONS

The standard offering for wood bay & bow windows is 'frame only', brickmould and subsill, subsill only, and brickmould on all sides. Other trim options subject to approval. Rough & Masonry openings remain consistent with all trim options.

VERTICAL ROUGH OPENING

Rough Opening typical for all Units

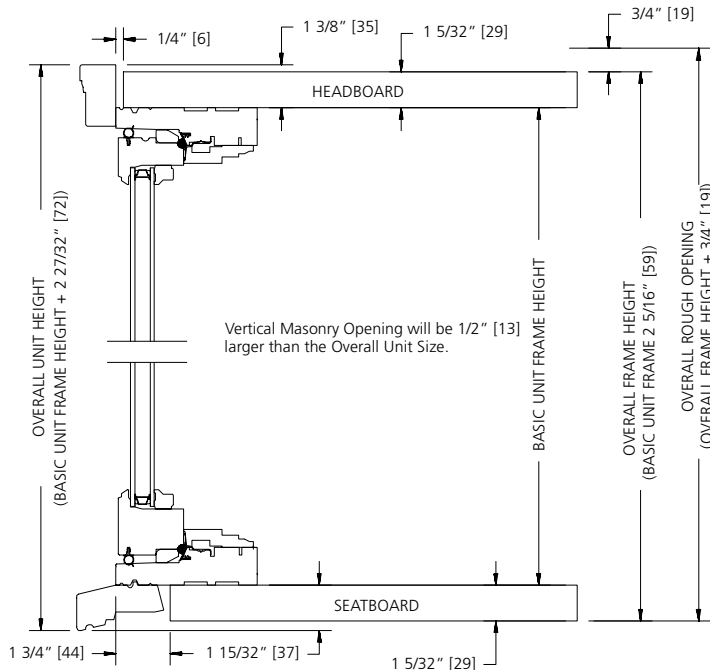

BRICKMOULD & SUBSILL

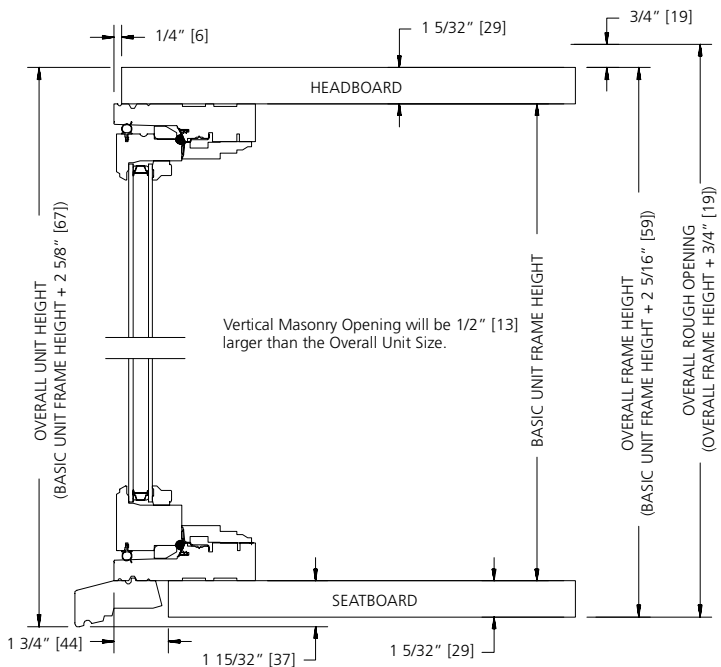

SUBSILL ONLY

HORIZONTAL ROUGH OPENING

Rough Opening typical for all Units

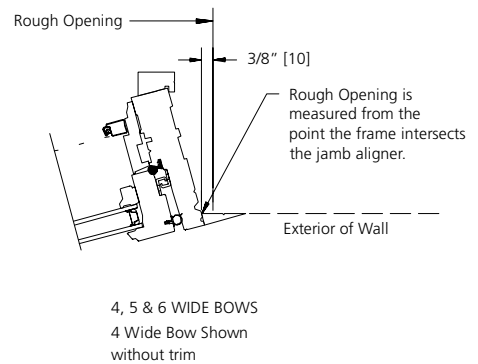
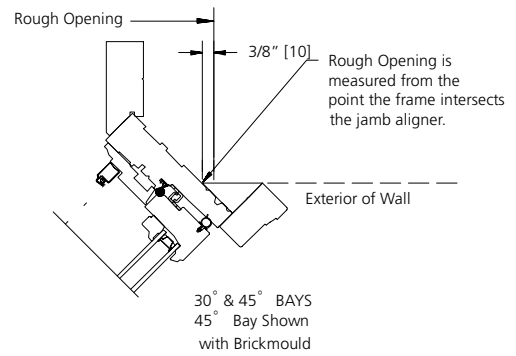

BAY & BOW WINDOW ROUGH OPENINGS

VERTICAL ROUGH OPENING

Rough Opening typical for all Units

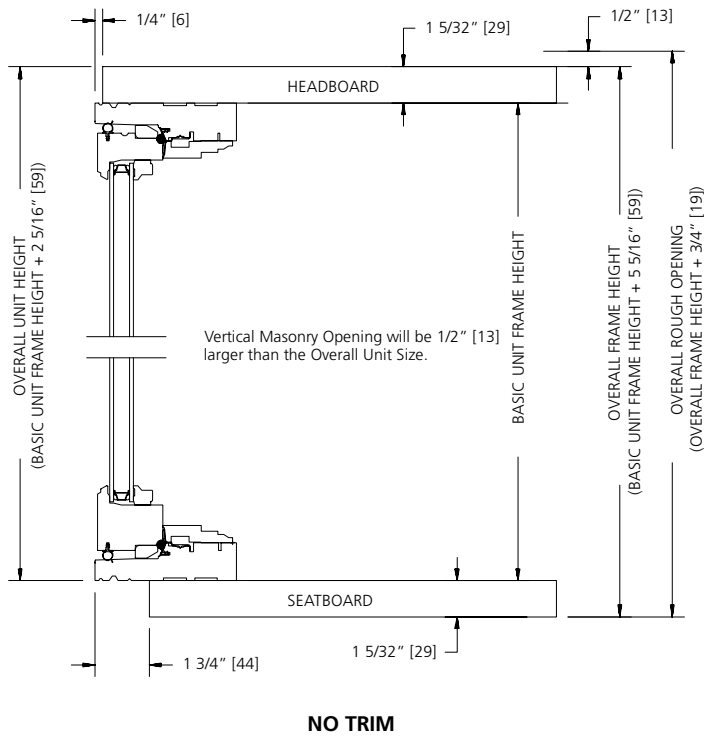

HORIZONTAL ROUGH OPENING

Rough Opening typical for all Units

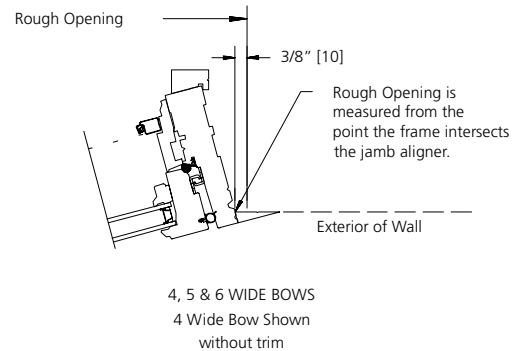
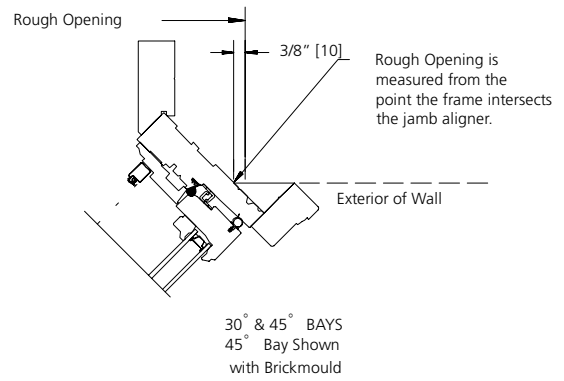

30° ANGLE BAY UNIT

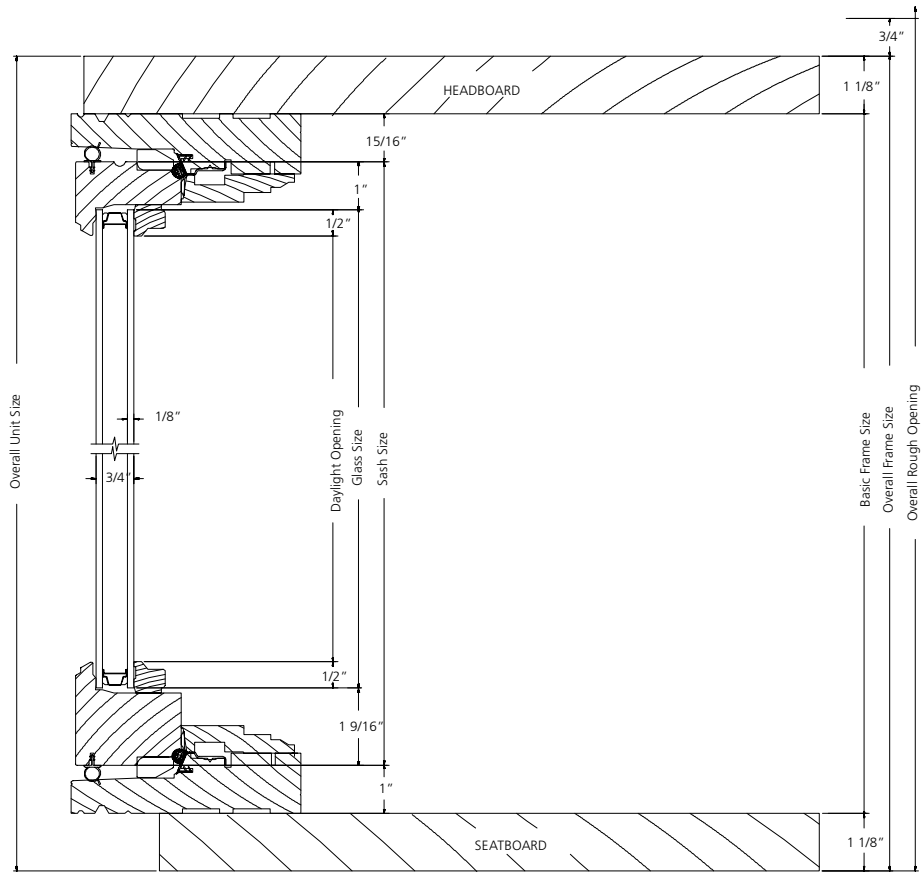

VERTICAL SECTION

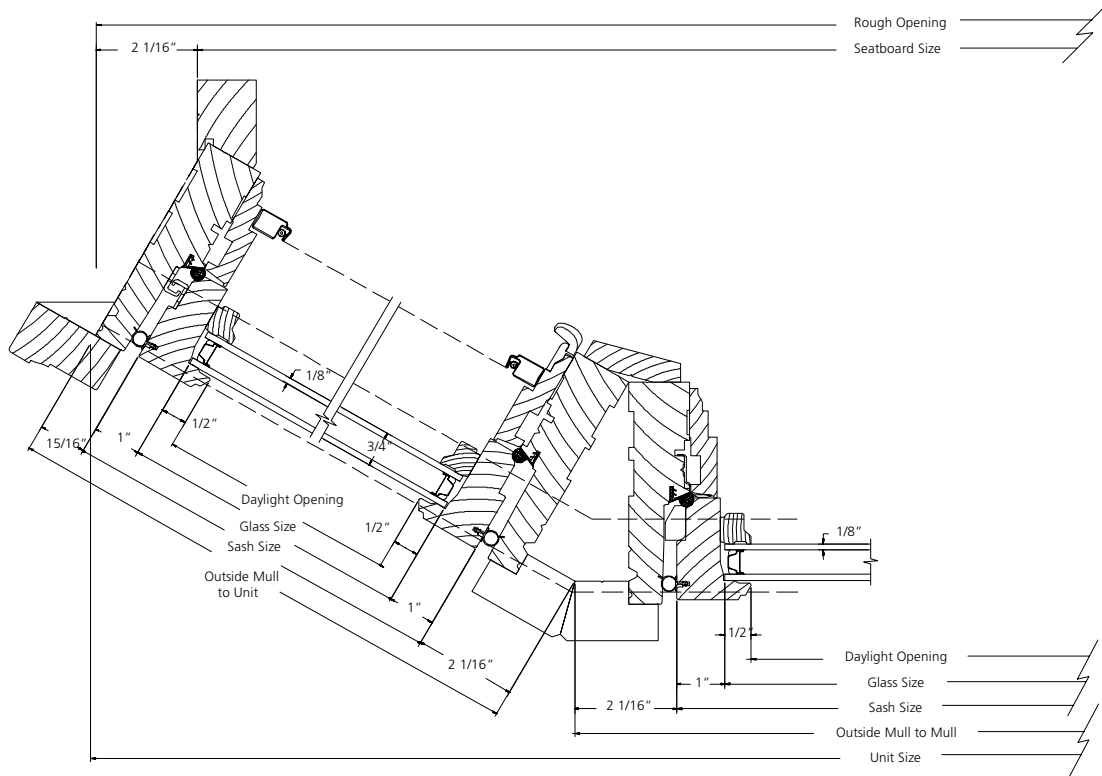

HORIZONTAL SECTION

SCALE: 3" = 1'

30° ANGLE BAY UNIT

SUBSILL

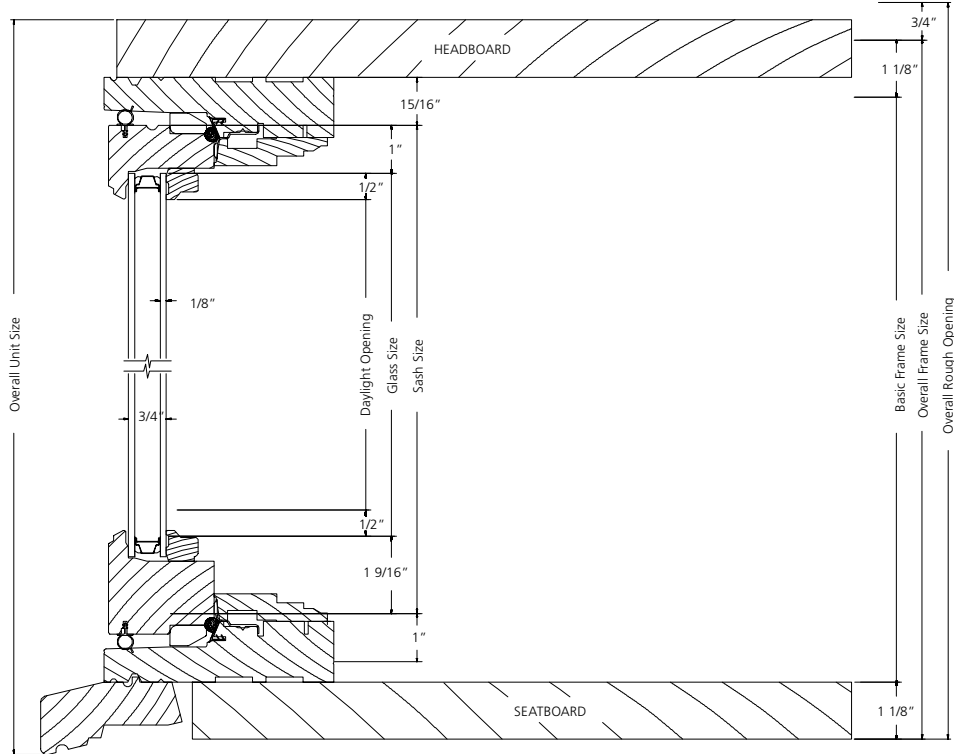

VERTICAL SECTION

BRICKMOULD AND SUBSILL

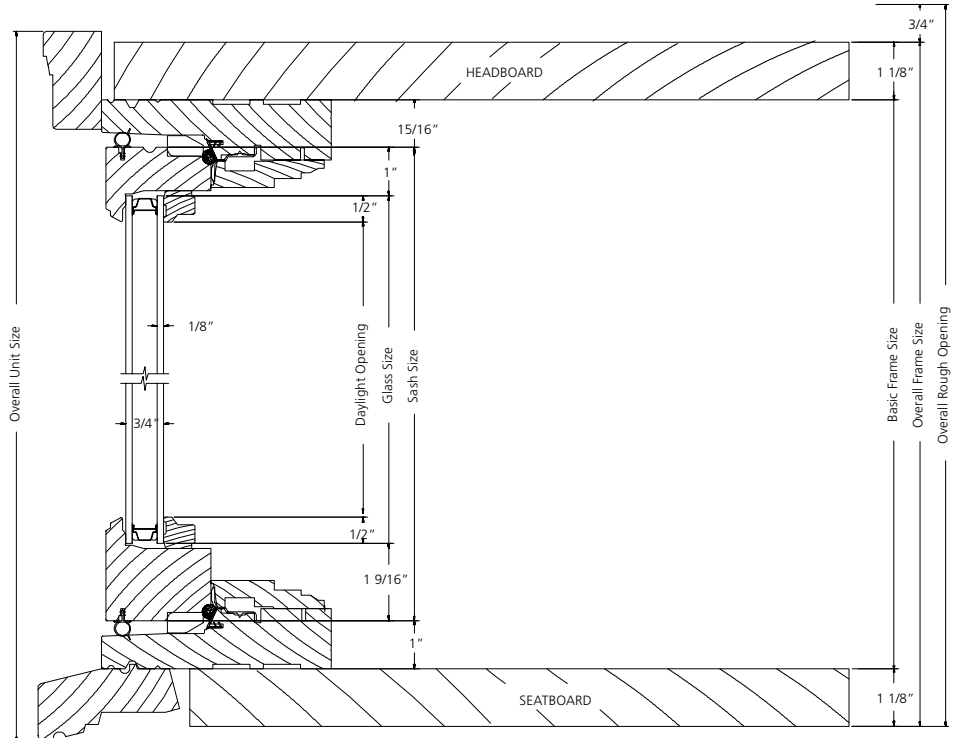

VERTICAL SECTION

SCALE: 3" = 1'

45° ANGLE BAY UNIT

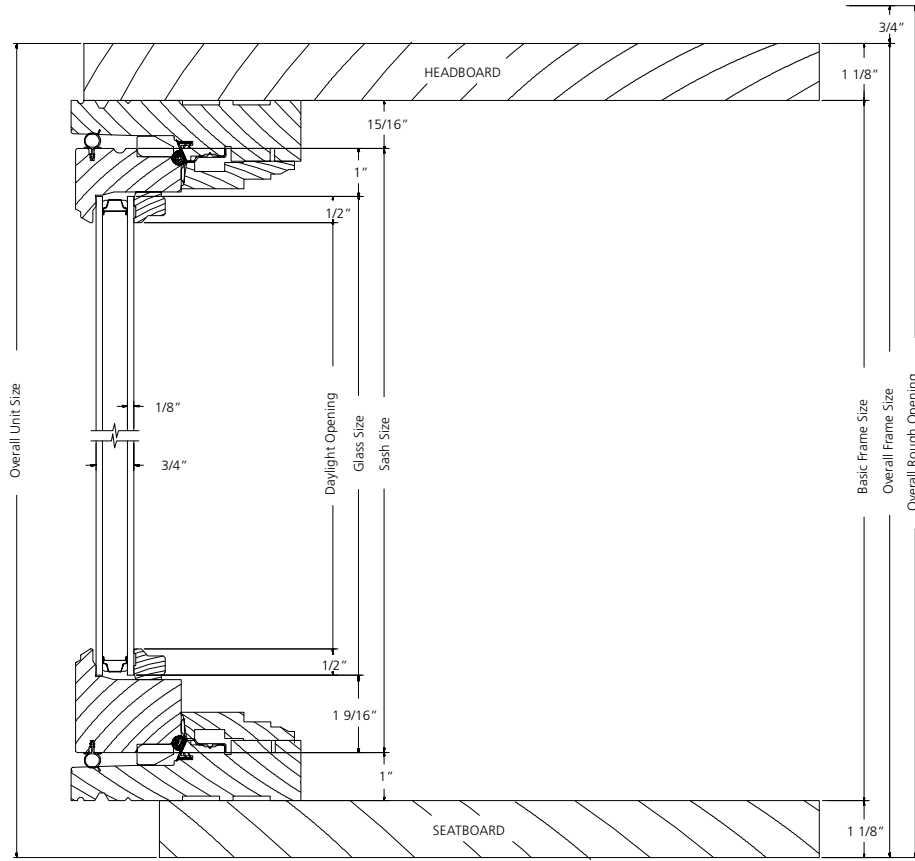

VERTICAL SECTION

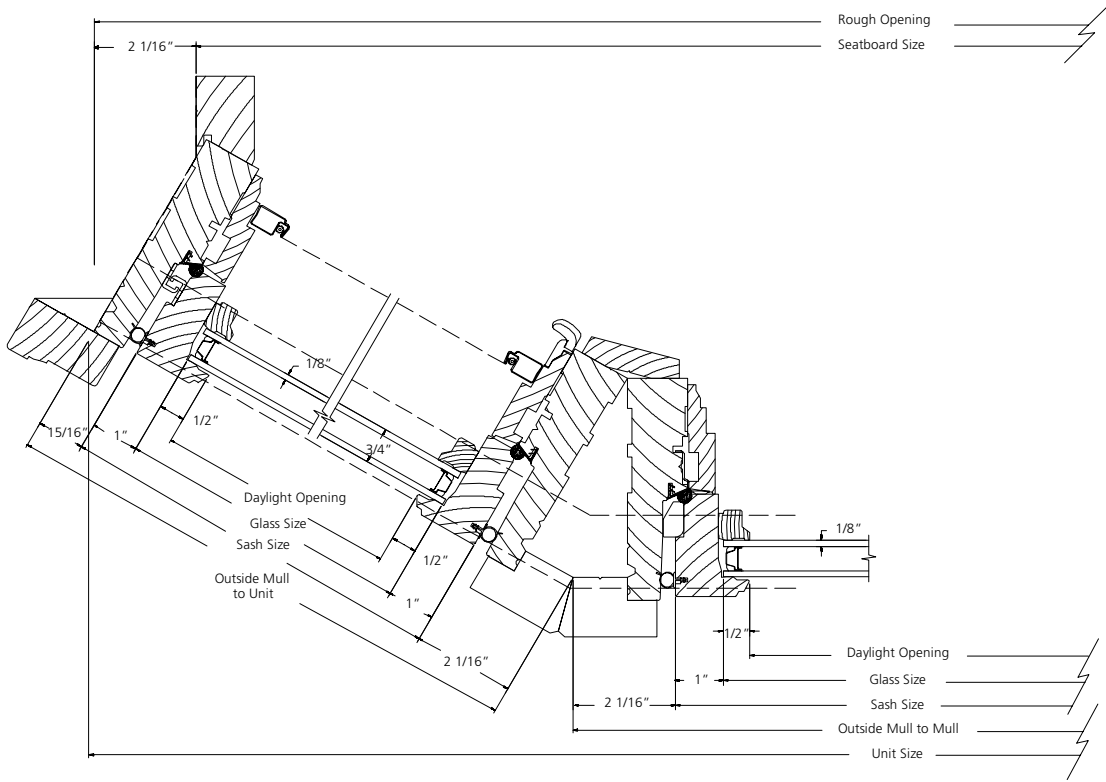

HORIZONTAL SECTION

SCALE: 3" = 1'

45° ANGLE BAY UNIT

SUBSILL

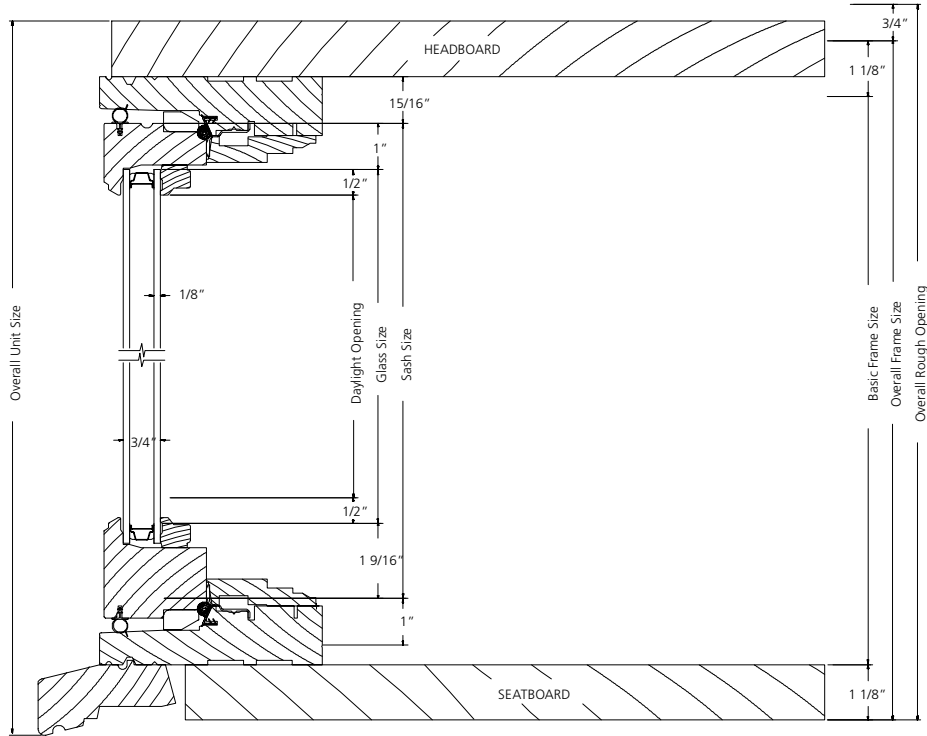

VERTICAL SECTION

BRICKMOULD AND SUBSILL

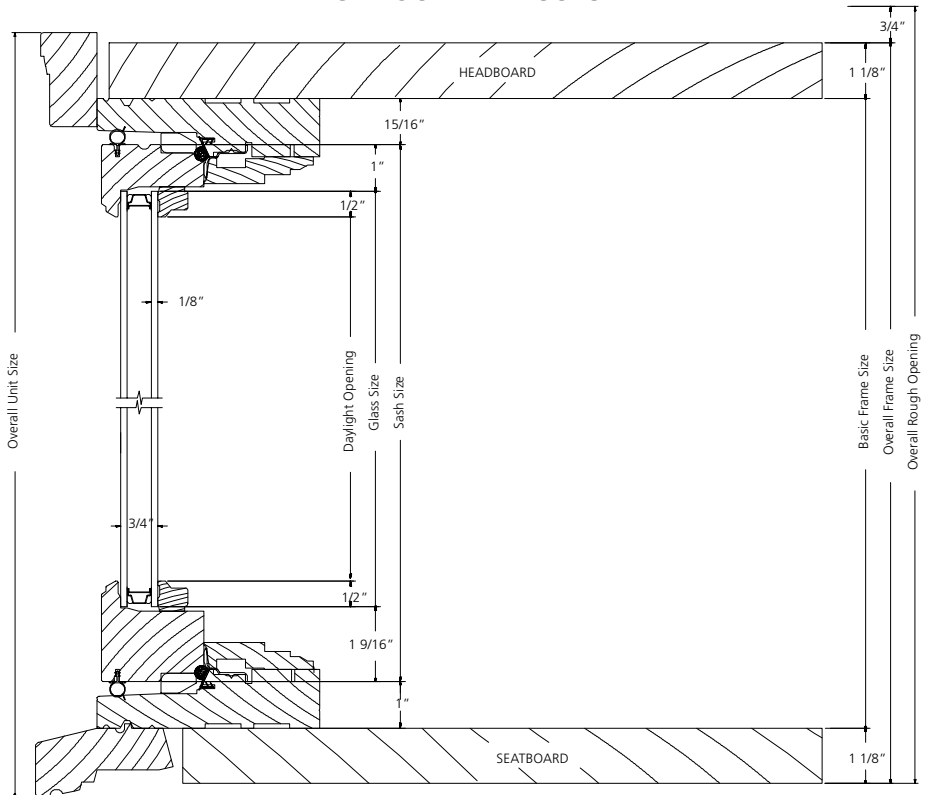

VERTICAL SECTION

SCALE: 3" = 1'

BOW UNITS 4-WIDE
NO TRIM

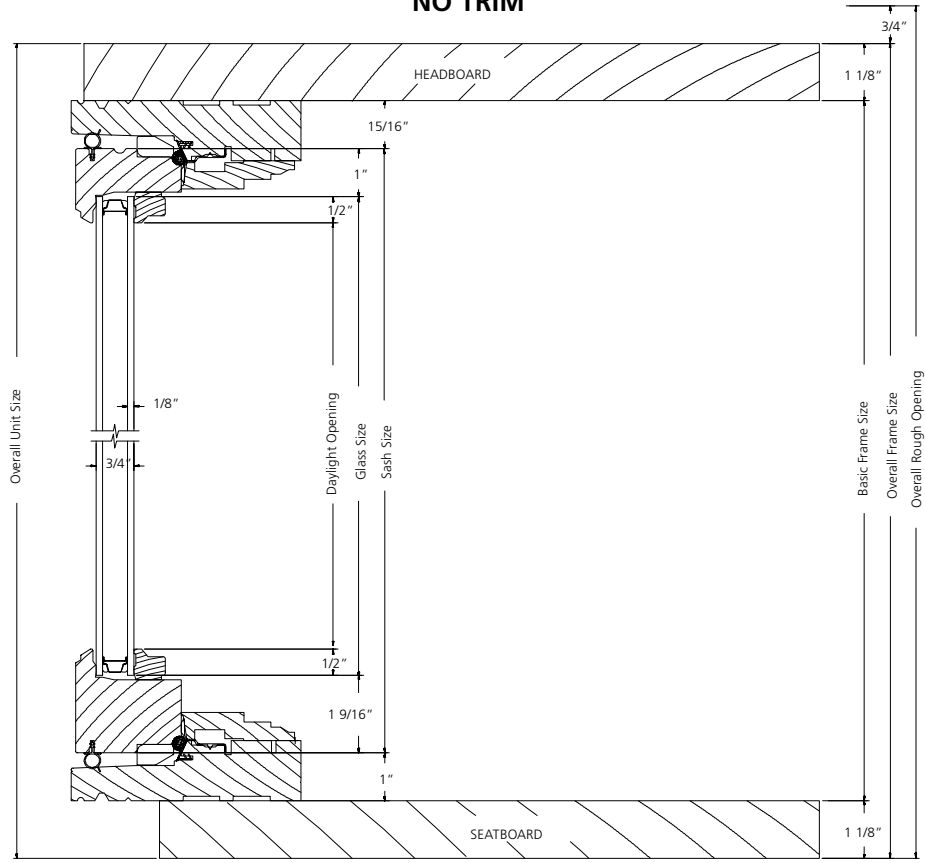

VERTICAL SECTION

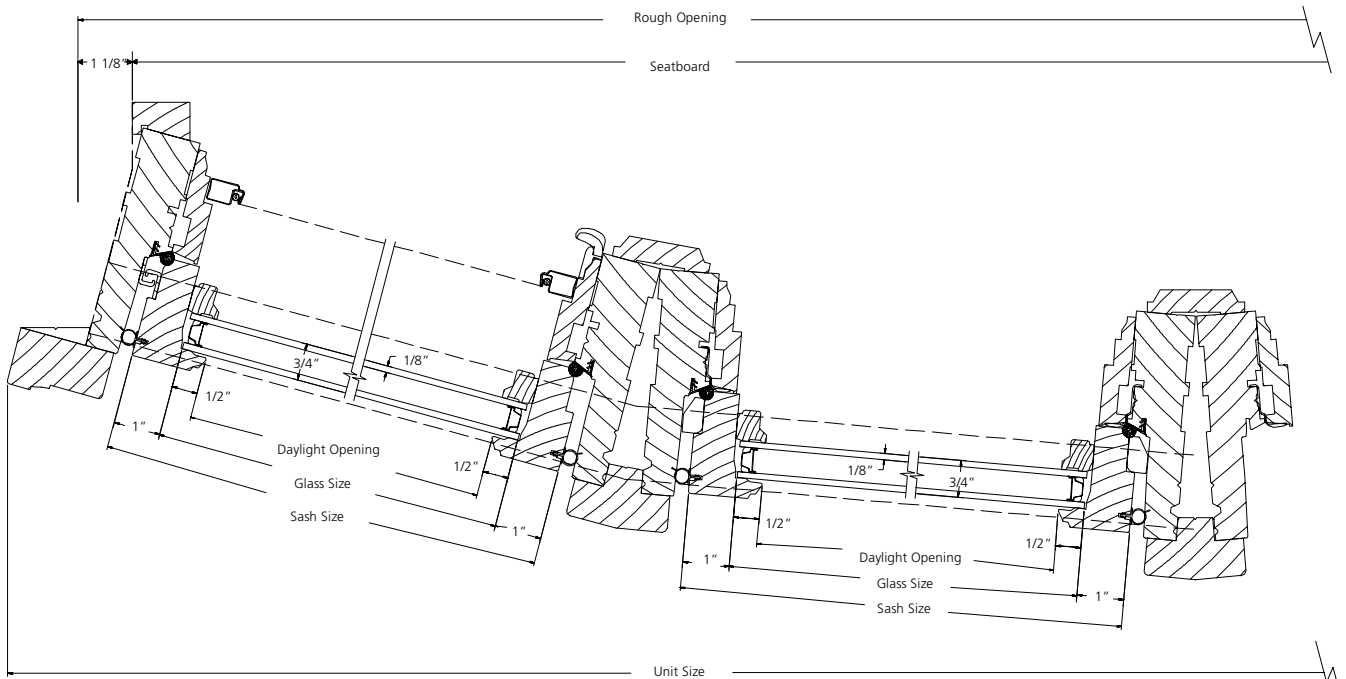

HORIZONTAL SECTION

SCALE: 3" = 1'

BOW UNITS 4-WIDE

SUBSILL

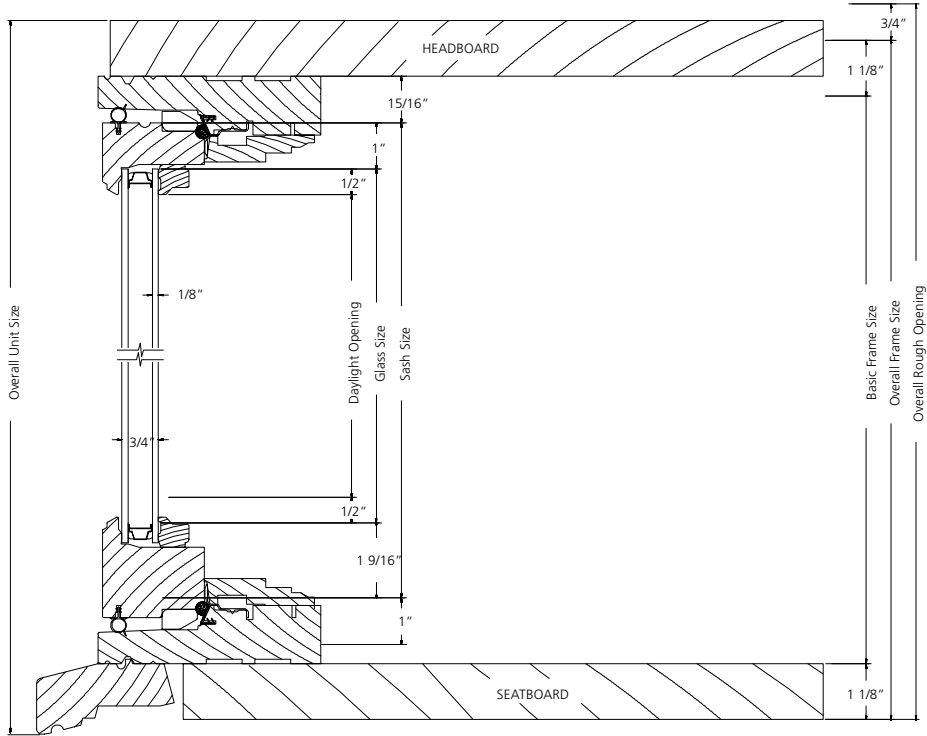

VERTICAL SECTION

BRICKMOULD AND SUBSILL

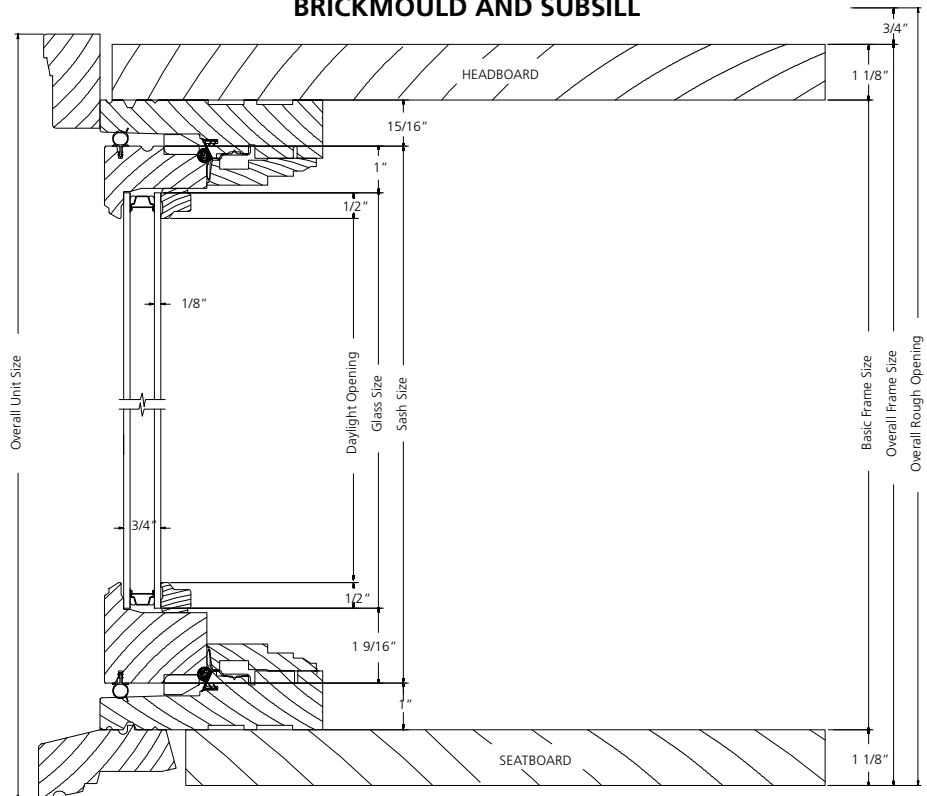

VERTICAL SECTION

SCALE: 3" = 1'

BOW UNITS 5-WIDE

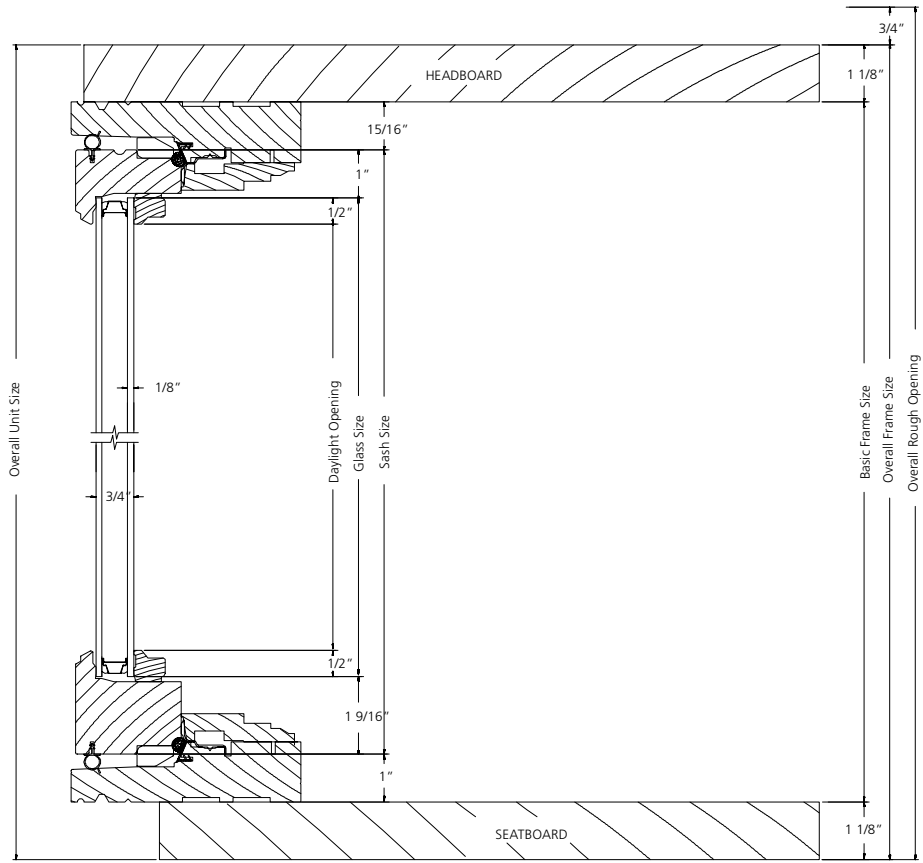

VERTICAL SECTION

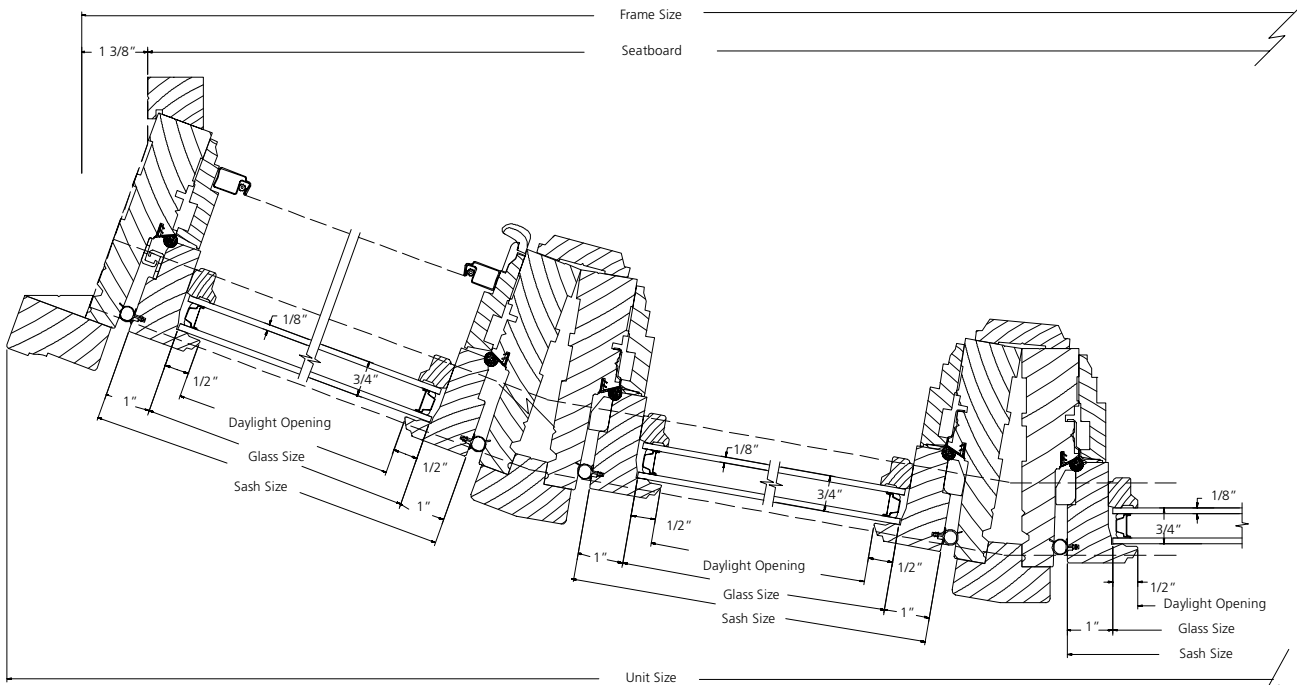

HORIZONTAL SECTION

SCALE: 3" = 1'

BOW UNITS 5-WIDE

SUBSILL

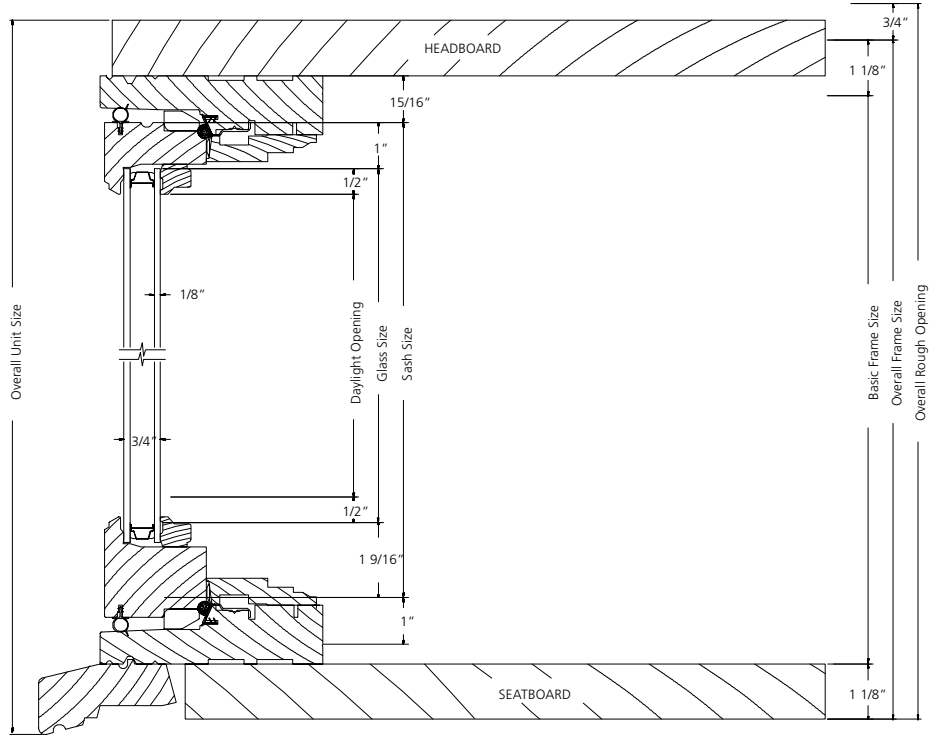

VERTICAL SECTION

BRICKMOULD AND SUBSILL

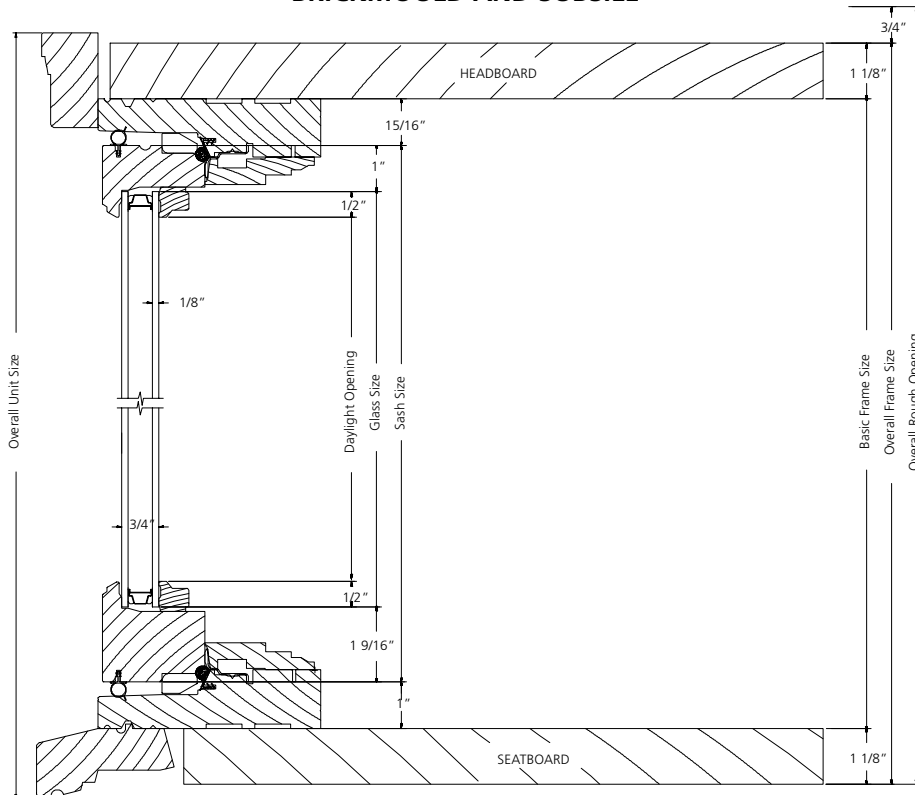

VERTICAL SECTION

SCALE: 3" = 1'

BOW UNITS 6-WIDE

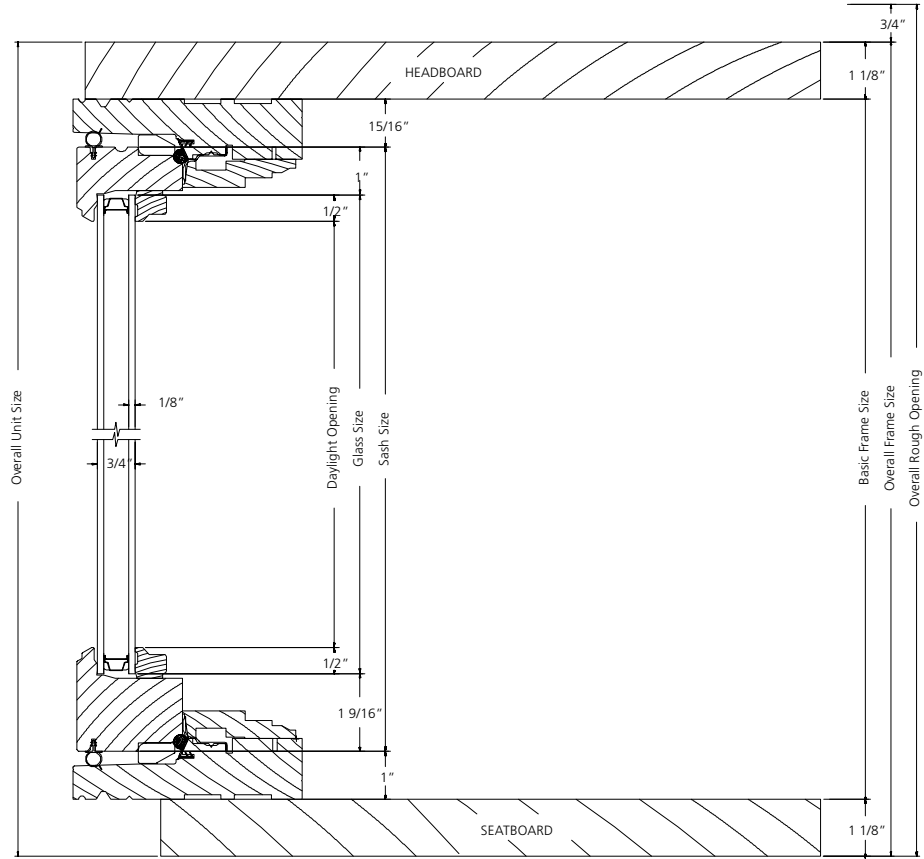

VERTICAL SECTION

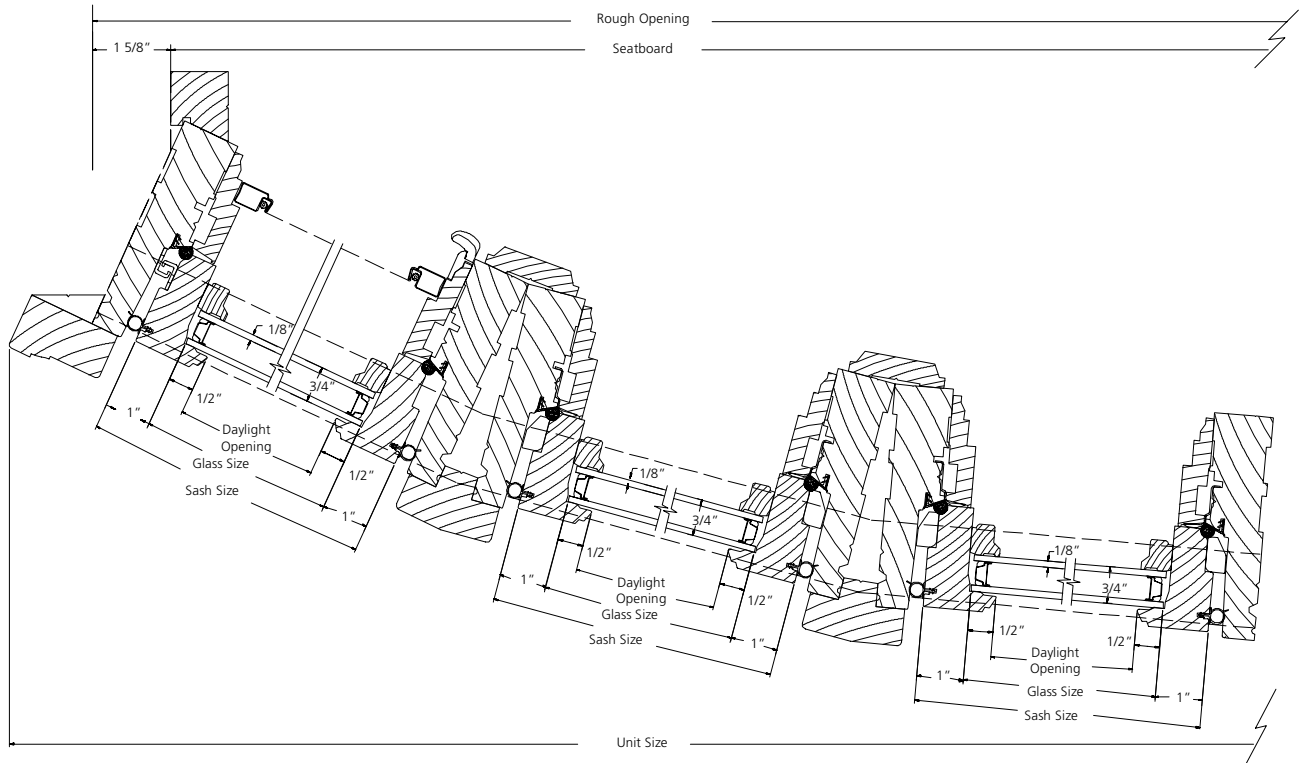

HORIZONTAL SECTION

SCALE: 3" = 1'

BOW UNITS 6-WIDE

SUBSILL

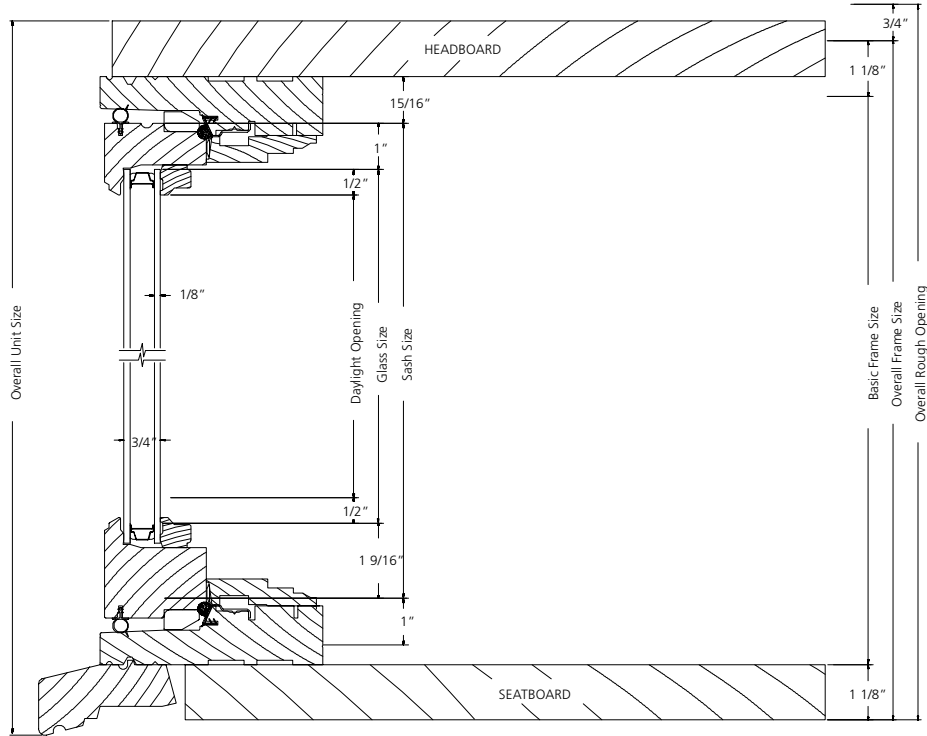

VERTICAL SECTION

BRICKMOULD AND SUBSILL

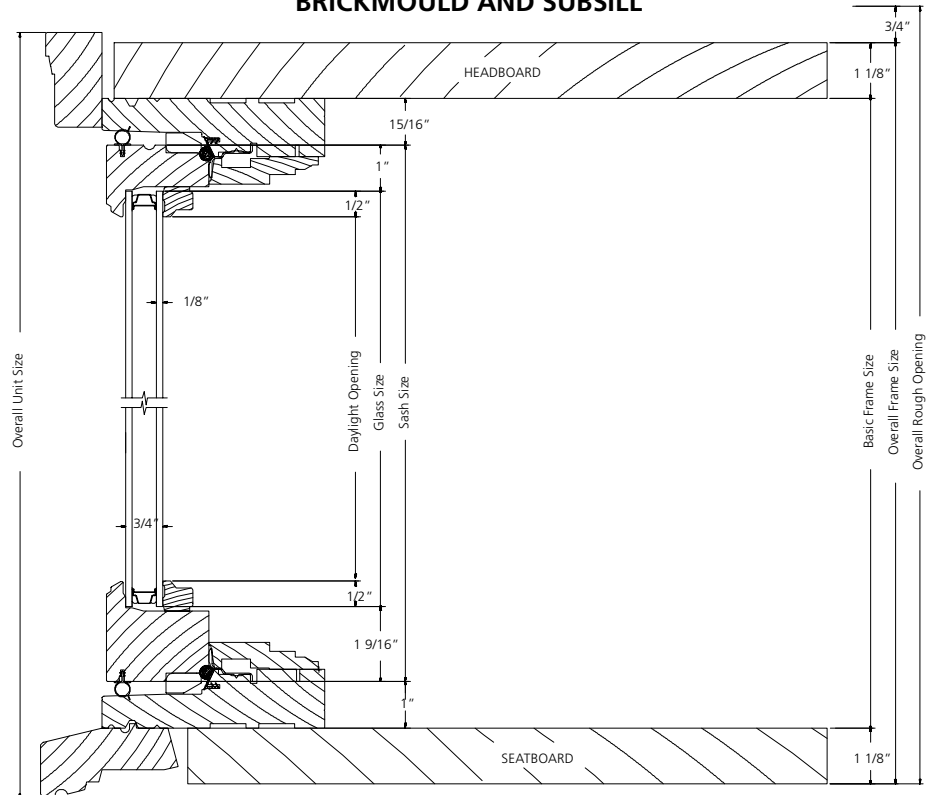

VERTICAL SECTION

SCALE: 3" = 1'