

TABLE OF CONTENTS

Specifications	13-2
Quick Spec Guides	13-6
Single & French Door Handing and Stationary Callouts	13-10
Elevations: 1/4" Scale	13-12
Single Swing In-Swing and Out-Swing	13-14
4-Panel Swing In-Swing and Out-Swing	13-17
Single Swing Commercial Width In-Swing and Out-Swing	13-19
Single Swing Commercial Width with Handicap Sill	13-20
French In-Swing and Out-Swing	13-21
Single Swing In-Swing and Out-Swing Clad Pine Bottom Panel	13-25
Single Swing In-Swing Sector Top	13-29
Single Swing Commercial Width In-Swing Sector Top	13-32
French In-Swing Sector Top	13-33
French Commercial Width In-Swing Sector Top	13-34
9-0 & 10-0 Tall Swing Doors	13-35
Swing Door Transom Alignment Guide	13-41
Swing Door Transoms	13-42
Panel Glazing Options: 3" Scale	13-46
Trim Options	13-47
Lite Cut Information	13-49
Clear Opening and Daylight Specifications	13-51
Unit Sizing, Rough Opening, and Masonry Openings	13-57
Section Details: 6" Scale	13-59
Section Details: 3" Scale	13-78

PRODUCT SPECIFICATIONS: SWINGING PATIO DOOR**EXTERIOR FINISH**

Exterior aluminum surfaces are low maintenance extruded aluminum coated with a thermo set polyester finish that meets or exceeds the AAMA 2603 performance standards. Standard colors include Brilliant White, Chestnut Bronze, Desert Sand, French Vanilla, Hartford Green, Mesa Red, Black, Arctic Silver and Dark Chocolate.

AURALAST® WOOD

AuraLast® wood is fundamentally different from wood resulting from traditional millwork preservation processes in that it uses a proprietary vacuum/pressure process to provide protection throughout the wood parts used to make windows and doors. AuraLast® wood is distinguished from wood using the current preservation methods by its unique ability to achieve greater penetration of the active ingredients into the wood parts, with a penetration of the treatment being a minimum of 92%.

INTERIOR FINISH

All interior surfaces are unfinished clear pine ready for on site finishing. Primed and pre-finished interiors are available in paint: Pure White, Extra White, Natural Choice, Moderate White; in stain: Wheat, Cherry, Cordovan; and Clear Lacquer.

FRAME

Frame is assembled from select kiln dried pine using AuraLast® wood on all exterior parts. Exterior surface of head and side jambs are covered with .050 (1.27mm) extruded aluminum cladding; corner joints are sealed with silicone and reinforced with a metal corner key and screw boss. Frames are finger jointed with an option for clear on most sizes. Frame thickness is 1-7/32" (31 mm) at head and side jamb and 11/16" (17.5mm) at sill. Basic jamb width is 4-9/16" (116mm) and may be extended for different wall depths. Integral nailing fin is part of head and side extrusion. Sill is constructed of a dark bronze one-piece pultruded fiberglass and a bronze anodized aluminum track. An integral wrapped foam sill weather-strip provides continuous seal against water and air infiltration. Two panel and four panel (quad) doors have continuous head and sill. Exterior of frame extrusions grooved to accept accessories.

PANEL

Panel is 1-23/32" (43.7mm) thick select kiln-dried pine using AuraLast® wood and engineered wood substrate which is water repellent preservative treated. Selected panel members have Timberstrand core for added strength and dimensional stability. Wood stiles and top rail are 4-9/16" (116mm) in face width and bottom rail is 5-5/16" (135mm) in face width on 6'8" height and 8-5/16" (211mm) on 6'11" and 8'0" heights. Panels are machine clamped to insure accurate squaring of the panel and joined with coped corners secured with multiple hardwood dowel pins. Exterior surfaces are covered with .050 (13mm) extruded aluminum with cope jointed and sealed corners. Quad doors have two stationary and two operating panels with a center astragal applied to the secondary active panel. The primary active panel is the left center panel on quad doors (viewed from the building exterior) unless otherwise specified.

GLAZING

3/4" (19mm) thick sealed insulating glass is constructed from two panes of tempered glass, utilizing a continuous roll formed stainless steel spacer with dual seal sealant. A computer-controlled application of clear silicone is used to bed the exterior of the insulating glass into the panel. An acrylic sealant is used to bed the interior. All insulating glass units comply with the performance requirements of IGCC in accordance with either ASTM E774 or E2190.

GLAZING OPTIONS

3/4" insulating glass available in Low-E with Argon, Low-E, Low-E 366, Clear, Neat Glass, reflective, tinted, or obscure, tempered or other specialty glass as specified. Preserve® film is a 0.003" thick polyethylene film with a low tack acrylic adhesive applied to the glass for protection during shipping and installation. 4,000 foot elevations and higher require a capillary tube to equalize environmental stress (otherwise known as High Altitude glazing). High Altitude glazing does not allow the use of Argon as listed under glazing options.

WEATHER-STRIPPING

Bronze colored wrapped resilient foam weather-strip is applied to the head and side jamb of door frame and to the center mull post. A multi-flanged door sweep is applied to the bottom of both active and stationary door panels. On Out-Swing doors, weather-strip is applied to the full perimeter of the frame, but sweep system is replaced by oak extension piece on the door panel which contacts resilient foam weather-strip on face of sill threshold.

HARDWARE

Single point system with solid brass handle set activates mortise lock. Integral dead bolt provides additional security. Multi-point system also available (standard on Segment Head, 8'0", 9'0" and 10'0" heights). Multi-point operates in similar fashion to single point but has two additional locking points activated by lifting up on handle after door is closed. Door handle sets may be specified Bright Brass or Antique Brass with heavy gauge mill finish strike plates. Optional handle sets come in Polished Chrome, Brushed Chrome, or Powder Coat White with stainless steel strike plates. Optional handle set in Oil Rubbed Bronze is also available with Oil Rubbed Bronze strike plates. Thruway construction handle is provided with each handle set. Keyway is Schlage "C".

EXTERIOR INSECT SCREENS (IN-SWING DOORS ONLY)

Charcoal fiberglass screen cloth (18x16 mesh) with clad color matched .040" (1mm) extruded aluminum frame. Standard sliding screen available for two and three panel doors (not available on doors with ADA sill). Door screen rides on a set of two adjustable steel rollers on outside track. Screen locking latch is factory-applied. An outward swing screen is available for single panel doors and is hinged the same as the door panel. Insect screens are intended to allow air and light in and to keep insects out. They are not intended to keep anyone or anything from falling through an open door. For safety screens or other security devices contact your local building supply retailer.

GRILLES

SDL (Simulated Divided Lites) - extruded aluminum muntins permanently applied to the exterior of the insulating glass unit (not available on textured glass) in 7/8" (22mm), 1-1/8" (28.5mm), or 1-3/8" (34.9mm) widths. SDL is standard with a light bronze internal shadow bar to give a true divided lite appearance. As an option, SDL may be ordered with a silver shadow bar. Clear wood interior muntin bars match the exterior muntin width and are permanently bonded to the interior of the glass. Also available is a 2-5/16" (59mm) SDL bar, which simulates a double-hung checkrail.

Full Surround Wood Grilles - Rectangular unfinished clear pine wood grilles in 7/8" (22mm) are available in patterns selected by the owner.

GBG (Grilles between the Glass) - 5/8" (15.9mm) flat and 23/32" or 1" contour mounted between the glass panes suspended within the air cavity.

Continued on next page

PRODUCT SPECIFICATIONS: SWINGING PATIO DOOR

EXTERIOR TRIM

1-5/8" (41mm) wide aluminum brickmould with an integral nailing fin is available factory applied. Also available is 3-1/2" (88.5mm) flat or Adams casing with an integral nailing fin. 1-1/2" retrofit brickmould casing is available as well. All of the accessories are .050" (1.3mm) extruded aluminum. Two sizes of frame expander, 1-7/8" (48mm) and 3-1/4" (83mm) may be used alone or in conjunction with a 2-1/8" (54mm) mull expander. Color and finish match exterior finish specs above.

EXTENSION JAMBS

In-Swing Doors have inline extruded extension jambs added to the exterior for jamb widths over 5-1/4". Intermediate jamb widths also have wood extension added to the inside up to 13/16". Out-Swing doors are extended to the interior with 21/32" thick pine to accommodate wall depth up to 9-15/16" with one piece and up to 12" with two pieces.

HANDING

Swing doors may be specified as In-Swing or Out-Swing (9'0" and 10'0" doors available as In-Swing only). Operation of door panel is viewed from exterior and should be specified according to handing callouts as specified in options section.

SILL PANS

Molded ABS plastic sill pan system is recommended for use in all patio door installations. The JELD-WEN Premium Wood Swinging Door sill pan must be specified when ordering and is field-installed prior to patio door placement.

INSTALLATION

Installation per JELD-WEN Installation Method for Metal Clad Patio Doors JII005 or JII014. See www.jeld-wen.com/resources for instructions.

PERFORMANCE

NFRC Certified - (Rated and labeled in accordance with NFRC)

WDMA Hallmark Certified -
In accordance with **AAMA/NWWDA/101/I.S.2-97**

PRODUCT SPECIFICATIONS: FRENCH SWINGING PATIO DOOR**EXTERIOR FINISH**

Exterior aluminum surfaces are low maintenance extruded aluminum frame and extruded aluminum sash coated with a thermo set polyester finish that meets or exceeds the AAMA 2603 performance standards. Standard colors include Brilliant White, Chestnut Bronze, Desert Sand, French Vanilla, Hartford Green, Mesa Red and Black.

AURALAST® WOOD

AuraLast® wood is fundamentally different from wood resulting from traditional millwork preservation processes in that it uses a proprietary vacuum/pressure process to provide protection throughout the wood parts used to make windows and doors. AuraLast® wood is distinguished from wood using the current preservation methods by its unique ability to achieve greater penetration of the active ingredients into the wood parts, with a penetration of the treatment being a minimum of 92%.

INTERIOR FINISH

All interior surfaces are unfinished clear pine ready for on site finishing. Primed and pre-finished interiors are available in paint: Pure White, Extra White, Natural Choice, Moderate White; in stain: Wheat, Cherry, Cordovan; and Clear Lacquer.

FRAME

Frame is assembled from select kiln dried pine using AuraLast® wood on all exterior parts. Exterior surface of head and side jambs are covered with .050 (1.27mm) extruded aluminum cladding; corner joints are sealed with silicone and reinforced with a metal corner key and screw boss. Frames are finger jointed with an option for clear on most sizes. Frame thickness is 1-1/4" (31.8 mm) at head and side jamb and 11/16" (17.5mm) at sill. Basic jamb width is 4-9/16" (116mm) and may be extended for different wall depths. Integral nailing fin is part of head and side extrusion. Sill is constructed of a dark bronze one-piece pulltruded fiberglass and oak threshold. Optional pulltruded fiberglass adjustable threshold is available on operating in-swing doors. Exterior of frame extrusion is grooved to accept accessories.

PANEL

Panel is 1-23/32" (43.7mm) thick select kiln-dried pine using AuraLast® wood and engineered wood substrate which is water repellent preservative treated. Selected panel members have Timberstrand core for added strength and dimensional stability. Wood stiles and top rail are 4-9/16" (116mm) in face width and bottom rail is 5-5/16" (135mm) in face width on 6'8" height and 8-5/16" (211mm) on 6'11" and 8'0" heights. Panels are machine clamped to insure accurate squaring of the panel and joined with coped corners secured with multiple hardwood dowel pins. Exterior surfaces are covered with .050 (13mm) extruded aluminum with cope jointed and sealed corners. Quad doors have two stationary and two operating panels with a center astragal applied to the secondary active panel. The primary active panel is the left center panel on quad doors (viewed from the building exterior) unless otherwise specified.

GLAZING

3/4" (19mm) thick sealed insulating glass is constructed from two panes of tempered glass, utilizing a continuous roll formed stainless steel spacer with dual seal sealant. A computer-controlled application of clear silicone is used to bed the exterior of the insulating glass into the panel. An acrylic sealant is used to bed the interior. All insulating glass units comply with the performance requirements of IGCC in accordance with either ASTM E774 or E2190.

GLAZING OPTIONS

3/4" insulating glass available in Low-E with Argon, Low-E, Low-E 366, Clear, Neat Glass, reflective, tinted, or obscure, tempered or other specialty glass as specified. Preserve® film is a 0.003" thick polyethylene film with a low tack acrylic adhesive applied to the glass for protection during shipping and installation. 4,000 foot elevations and higher require a capillary tube to equalize environmental stress (otherwise known as High Altitude glazing). High Altitude glazing does not allow the use of Argon as listed under glazing options.

WEATHER-STRIPPING

Bronze colored wrapped resilient foam weather-strip is applied to the head and side jamb of door frame and to the center mull post. A multi-flanged door sweep is applied to the bottom of both active and stationary door panels. On Out-Swing doors, weather-strip is applied to the full perimeter of the frame, but sweep system is replaced by oak extension piece on the door panel which contacts resilient foam weather-strip on face of sill threshold.

HARDWARE

Single point system with solid brass handle set activates mortise lock. Integral dead bolt provides additional security. Multi-point system also available (standard on Segment Head, 8'0", 9'0" and 10'0" heights). Multi-point operates in similar fashion to single point but has two additional locking points activated by lifting up on handle after door is closed. Door handle sets may be specified Bright Brass or Antique Brass with heavy gauge mill finish strike plates. Optional handle sets come in Polished Chrome, Brushed Chrome, or Powder Coat White with stainless steel strike plates. Optional handle set in Oil Rubbed Bronze is also available with Oil Rubbed Bronze strike plates. Thruway construction handle is provided with each handle set. Keyway is Schlage "C".

**EXTERIOR INSECT SCREENS
(IN-SWING DOORS ONLY)**

Charcoal fiberglass screen cloth (18x16 mesh) with clad color matched .040" (1mm) extruded aluminum frame. An outward swing screen is available for single panel doors and is hinged the same as the door panel. Insect screens are intended to allow air and light in and to keep insects out. They are not intended to keep anyone or anything from falling through an open door. For safety screens or other security devices contact your local building supply retailer.

GRILLES

SDL (Simulated Divided Lites) - extruded aluminum muntins permanently applied to the exterior of the insulating glass unit (not available on textured glass) in 7/8" (22mm), 1-1/8" (28.5mm), or 1-3/8" (34.9mm) widths. SDL is standard with a light bronze internal shadow bar to give a true divided lite appearance. As an option, SDL may be ordered with a silver shadow bar. Clear wood interior muntin bars match the exterior muntin width and are permanently bonded to the interior of the glass. Also available is a 2-5/16" (59mm) SDL bar, which simulates a double-hung checkrail.

Full Surround Wood Grilles - Rectangular unfinished clear pine wood grilles in 7/8" (22mm) are available in patterns selected by the owner.

GBG (Grilles between the Glass) - 5/8" (15.9mm) flat and 23/32" or 1" contour mounted between the glass panes suspended within the air cavity.

Continued on next page

PRODUCT SPECIFICATIONS: FRENCH SWINGING PATIO DOOR

EXTERIOR TRIM

1-5/8" (41mm) wide aluminum brickmould with an integral nailing fin is available factory applied. Also available is 3-1/2" (88.5mm) flat or Adams casing with an integral nailing fin. 1-1/2" retrofit brickmould casing is available as well. All of the accessories are .050" (1.3mm) extruded aluminum. Two sizes of frame expander, 1-7/8" (48mm) and 3-1/4" (83mm) may be used alone or in conjunction with a 2-1/8" (54mm) mull expander. Color and finish match exterior finish specs above.

EXTENSION JAMBS

In-Swing Doors have inline extruded extension jambs added to the exterior for jamb widths over 5-1/4". Intermediate jamb widths also have wood extension added to the inside up to 13/16". Out-Swing doors are extended to the interior with 21/32" thick pine to accommodate wall depth up to 9-15/16" with one piece and up to 12" with two pieces.

HANDING

Swing doors may be specified as In-Swing or Out-Swing (9'0" and 10'0" doors available as In-Swing only). Operation of door panel is viewed from exterior and should be specified according to handing callouts as specified in options section.

SILL PANS

Molded ABS plastic sill pan system is recommended for use in all patio door installations. The JELD-WEN Premium Wood Swinging Door sill pan must be specified when ordering and is field-installed prior to patio door placement.

INSTALLATION

Installation per JELD-WEN Installation Method for Metal Clad Patio Doors JII005 or JII014. See www.jeld-wen.com/resources for instructions.

PERFORMANCE

NFRC Certified - (Rated and labeled in accordance with NFRC)

WDMA Hallmark Certified -
In accordance with **AAMA/NWWDA/101/I.S.2-97**

QUICK SPEC GUIDE: SWINGING PATIO DOOR

SPECIFICATION	STANDARD FEATURES	OPTIONAL FEATURES <i>Some options may require additional lead times. Consult your JELD-WEN Sales Representative.</i>
FRAME	<ul style="list-style-type: none"> Fingerjoint Wood 	<ul style="list-style-type: none"> Clear available on most sizes
EXTERIOR FINISH	<ul style="list-style-type: none"> Brilliant White Chestnut Bronze Desert Sand French Vanilla Mesa Red Hartford Green Black Arctic Silver Dark Chocolate 	
EXTERIOR TRIM	<ul style="list-style-type: none"> Nailing Fin Drip Cap 	<ul style="list-style-type: none"> Aluminum 1-5/8" Brickmould with integral nailing fin Aluminum 1-1/2" Retrofit Brickmould 3-1/2" Flat Casing with integral nailing fin Adams Clad Brickmould with integral nailing fin
INTERIOR FINISH	<ul style="list-style-type: none"> Natural 	<ul style="list-style-type: none"> Priming Available Pre-finished Interior Options are: <ul style="list-style-type: none"> Paint - Pure White, Extra White, Natural Choice, Moderate White Stain - Wheat, Fruitwood, Cherry, Cordovan Clear Lacquer
SIZE	<ul style="list-style-type: none"> Width: <ul style="list-style-type: none"> One Panel - 2-6, 2-9, 3-0, 3' 2-9/16, 3-6 Two Panel - 5-0, 5-6, 6-0, 6' 5-1/8, 7-0 Three Panel - 7-6, 8-3, 9-0, 9' 7-11/16, 10-6 Four Panel - 8-0, 10-0, 11-0, 12-0 Sidelight Width - 1-0, 1-6, 2-0 Height: <ul style="list-style-type: none"> 6-8, 6-11, 7-3, 8-0, 9-0, 10-0 Sidelight Height: <ul style="list-style-type: none"> 6-8, 6-11, 7-3, 8-0 	<ul style="list-style-type: none"> Minimum Width: 2-0 Maximum Width: 3-6 Minimum Width: 4-0 Maximum Width: 7-0 Maximum Multi Panel Frame Width: 12-0 Minimum Sidelight Frame Width: 1-0 Minimum Height: 2-0 Maximum Height: 10-0 Maximum Sidelight Frame Height: 8-0
GLAZING	<ul style="list-style-type: none"> Tempered Low-E Insulating Glass Preserve® Protective Film 	<ul style="list-style-type: none"> Clear Obscure Bronze Low-E 366 Neat Glass Reflective Tempered
GRILLES		<ul style="list-style-type: none"> 5/8" Flat, 23/32" or 1" Contour GBG 7/8" Full Surround Wood Grilles SDL Bead Profile: <ul style="list-style-type: none"> 7/8", 1-1/8", 1-3/8", 2-5/16" with Light Bronze Shadow Bar 7/8", 1-1/8", 1-3/8", 2-5/16" with Silver Shadow Bar
PANEL OPTIONS		<ul style="list-style-type: none"> Lock Rail Swing Door Clad Pine Bottom Panel 12" ADA Bottom Rail
HARDWARE	<ul style="list-style-type: none"> Single Point (standard up to 7 2-1/2) Multi-point (standard on 8-0 and over) Multi-point (available on 6-2 and over) 	<ul style="list-style-type: none"> Multi-point optional on 7-3 heights and smaller

Continued on next page

QUICK SPEC GUIDE: SWINGING PATIO DOOR

SPECIFICATION	STANDARD FEATURES	OPTIONAL FEATURES <i>Some options may require additional lead times. Consult your JELD-WEN Sales Representative.</i>
HANDLESET	<ul style="list-style-type: none"> • Antique Brass • Polished Brass 	<ul style="list-style-type: none"> • Polished Chrome • Brushed Chrome • Powder Coat White • Oil Rubbed Bronze • Satin Nickel
HINGES	<ul style="list-style-type: none"> • In-Swing Hinges Match Handle Color • Out-Swing Hinges - Brushed Stainless Steel 	<ul style="list-style-type: none"> • Adjustable Hinge Available
SILL	<ul style="list-style-type: none"> • Dark bronze one-piece pulltruded fiberglass and oak threshold 	<ul style="list-style-type: none"> • ADA Sill Option • Pulltruded Fiberglass Adjustable Threshold
HANDING	<ul style="list-style-type: none"> • Viewed from the outside 	
JAMB	<ul style="list-style-type: none"> • 4-9/16" 	<ul style="list-style-type: none"> • Minimum: 4-9/16" • Maximum In-Swing (Exterior): 9-1/16" • Exterior: Extruded Aluminum for In-Swing Doors • Maximum Out-Swing (Interior): 9-3/8" (one piece) • Interior Pine for Out-Swing Doors
SCREENS	<ul style="list-style-type: none"> • Fiberglass • Extruded Aluminum Frame 	<ul style="list-style-type: none"> • Sliding screen available on In-Swing doors only • Hinged Screen available on In-Swing doors only
SCREEN FRAME COLOR	<ul style="list-style-type: none"> • Brilliant White • Chestnut Bronze • Desert Sand • French Vanilla • Mesa Red • Hartford Green • Black • Arctic Silver • Dark Chocolate 	

QUICK SPEC GUIDE: FRENCH SWINGING PATIO DOOR

SPECIFICATION	STANDARD FEATURES	OPTIONAL FEATURES <i>Some options may require additional lead times. Consult your JELD-WEN Sales Representative.</i>
FRAME	<ul style="list-style-type: none"> Fingerjoint Wood 	<ul style="list-style-type: none"> Clear available on most sizes
EXTERIOR FINISH	<ul style="list-style-type: none"> Brilliant White Chestnut Bronze Desert Sand French Vanilla Mesa Red Hartford Green Black Arctic Silver Dark Chocolate 	
EXTERIOR TRIM	<ul style="list-style-type: none"> Nailing Fin Drip Cap 	<ul style="list-style-type: none"> Aluminum 1-5/8" Brickmould with integral nailing fin Aluminum 1-1/2" Retrofit Brickmould 3-1/2" Flat Casing with integral nailing fin Adams Clad Brickmould with integral nailing fin
INTERIOR FINISH	<ul style="list-style-type: none"> Natural 	<ul style="list-style-type: none"> Priming Available <p>Pre-finished Interior Options are:</p> <ul style="list-style-type: none"> Paint - Pure White, Extra White, Natural Choice, Moderate White Stain - Wheat, Fruitwood, Cherry, Cordovan Clear Lacquer
SIZE	<ul style="list-style-type: none"> Width: Two Panel - 5-0, 5-6, 6-0, 6' 5-1/8, 7-0 Three Panel - 7-6, 8-3, 9-0, 9' 7-11/16, 10-6 Four Panel - 8-0, 10-0, 11-0, 12-0 Height: 6-8, 6-11, 7-3, 8-0, 9-0, 10-0 	<ul style="list-style-type: none"> Minimum Width: 3-0 Maximum Width: 7-0 Maximum Multi Panel Frame Width: 12-0 Minimum Height: 2-0 Maximum Height: 10-0
GLAZING	<ul style="list-style-type: none"> Tempered Low-E Insulating Glass Preserve® Protective Film 	<ul style="list-style-type: none"> Clear Obscure Bronze Low-E 366 Neat Glass Reflective Tempered
		<ul style="list-style-type: none"> High Altitude
GRILLES		<ul style="list-style-type: none"> 5/8" Flat, 23/32" or 1" Contour GBG 7/8" Full Surround Wood Grilles <p>SDL Bead Profile:</p> <ul style="list-style-type: none"> 7/8", 1-1/8", 1-3/8", 2-5/16" with Light Bronze Shadow Bar 7/8", 1-1/8", 1-3/8", 2-5/16" with Silver Shadow Bar
PANEL OPTIONS		<ul style="list-style-type: none"> Lock Rail Swing Door Clad Pine Bottom Panel
HARDWARE	<ul style="list-style-type: none"> Single Point (standard up to 7 2-1/2) Multi-point (standard on 8-0 and over) Multi-point (available on 6-2 and over) 	<ul style="list-style-type: none"> Multi-point optional on 7-3 heights and smaller

Continued on next page

QUICK SPEC GUIDE: FRENCH SWINGING PATIO DOOR

SPECIFICATION	STANDARD FEATURES	OPTIONAL FEATURES <i>Some options may require additional lead times. Consult your JELD-WEN Sales Representative.</i>
HANDLESET	<ul style="list-style-type: none"> • Antique Brass • Polished Brass 	<ul style="list-style-type: none"> • Brushed Chrome • Polished Chrome • Powder Coat White • Oil Rubbed Bronze • Satin Nickel
HINGES	<ul style="list-style-type: none"> • In-Swing Hinges Match Handle Color • Out-Swing Hinges - Brushed Stainless Steel 	<ul style="list-style-type: none"> • Adjustable Hinge Available
SILL	<ul style="list-style-type: none"> • Dark bronze one-piece pulltruded fiberglass and oak threshold 	<ul style="list-style-type: none"> • ADA Sill Option • Pulltruded Fiberglass Adjustable Threshold
HANDING	<ul style="list-style-type: none"> • Viewed from the outside 	
JAMB	<ul style="list-style-type: none"> • 4-9/16" 	<ul style="list-style-type: none"> • Minimum: 4-9/16" • Maximum In-Swing (Exterior): 9-1/16" • Exterior: Extruded Aluminum for In-Swing Doors • Maximum Out-Swing (Interior): 9-3/8" (one piece) • Interior Pine for Out-Swing Doors
SCREENS	<ul style="list-style-type: none"> • Fiberglass • Extruded Aluminum Frame 	<ul style="list-style-type: none"> • Hinged Screen available on In-Swing doors only
SCREEN FRAME COLOR	<ul style="list-style-type: none"> • Brilliant White • Chestnut Bronze • Desert Sand • French Vanilla • Mesa Red • Hartford Green • Black • Arctic Silver • Dark Chocolate 	

SWINGING DOOR HANDING AND STATIONARY CALLOUTS

Doors pictured as viewed from exterior.

Top down view shows panels as In-Swing.

All extension is opposite panel swing.

OUT-SWING OPTION:
Numerical callout for Out-Swing doors does not change. Add "Out-Swing" to description and use TO callout.

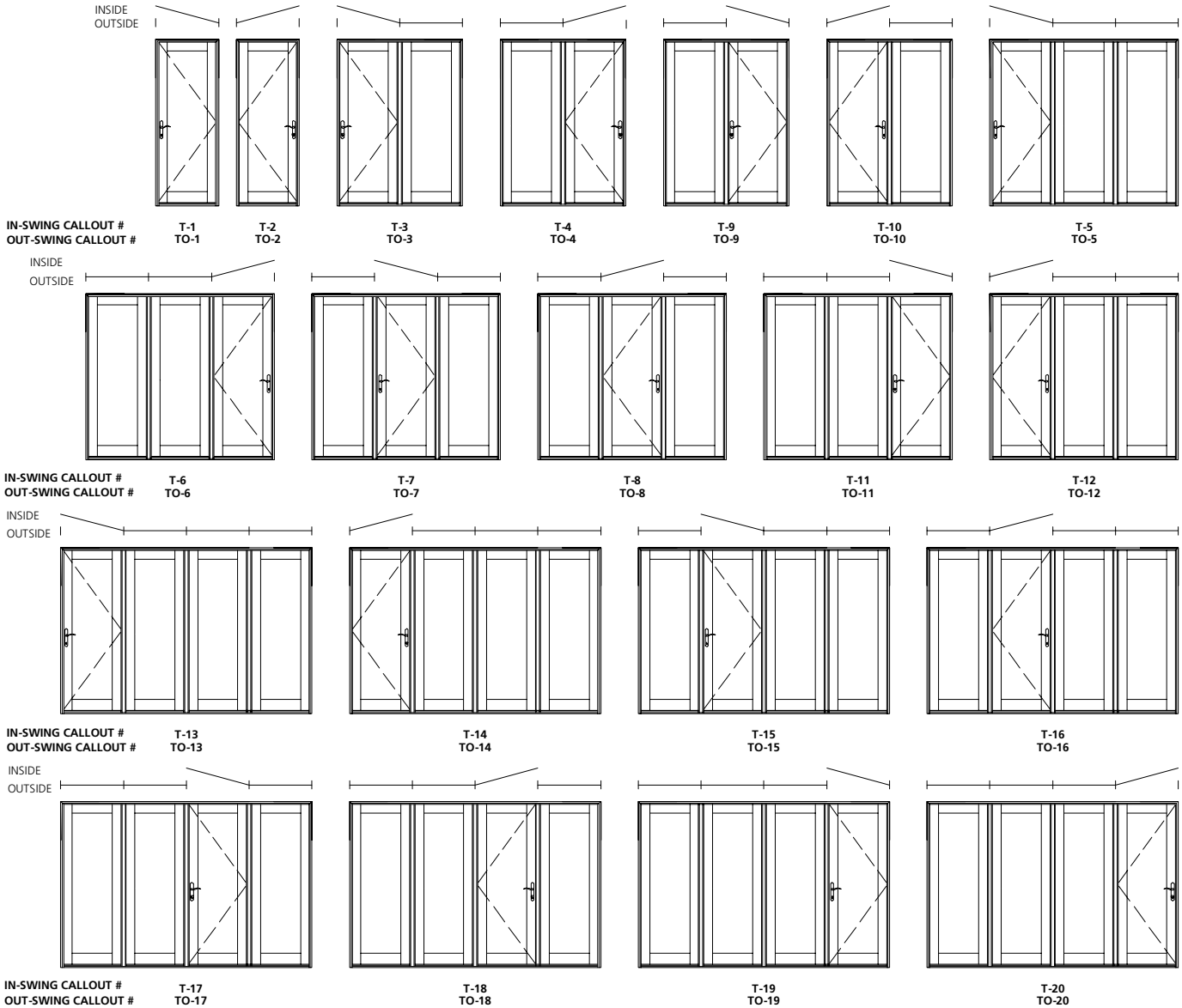

FRENCH DOOR HANDING AND STATIONARY CALLOUTS

OUT-SWING OPTION:
Numerical callout for Out-Swing doors does not change. Add "Out-Swing" to description and use FO callout.

Top down view shows panels as In-Swing.

All extension is opposite panel swing.

Doors pictured as viewed from exterior.

INSIDE
OUTSIDE

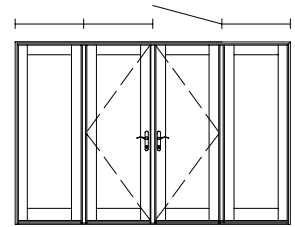
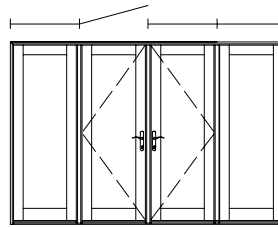
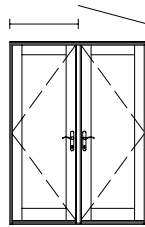
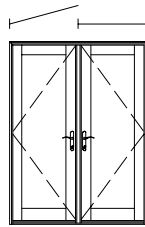

IN-SWING CALLOUT # F-1
OUT-SWING CALLOUT # FO-1

F-2
FO-2

F-3
FO-3

F-4
FO-4

INSIDE
OUTSIDE

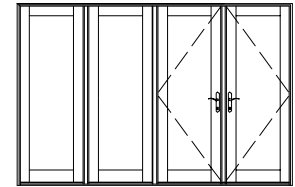
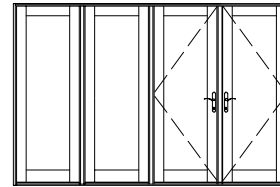
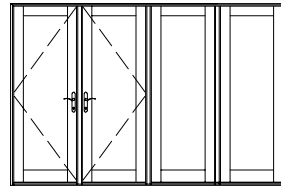
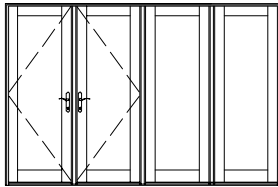

IN-SWING CALLOUT # F-5
OUT-SWING CALLOUT # FO-5

F-6
FO-6

F-7
FO-7

F-8
FO-8

INSIDE
OUTSIDE

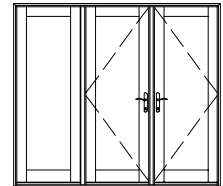
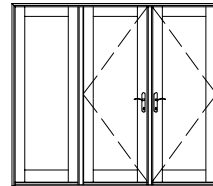
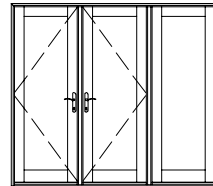
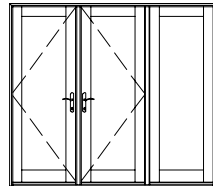

IN-SWING CALLOUT # F-9
OUT-SWING CALLOUT # FO-9

F-10
FO-10

F-11
FO-11

F-12
FO-12

STATIONARY IN-SWING AND OUT-SWING - STANDARD HANDING

INSIDE
OUTSIDE

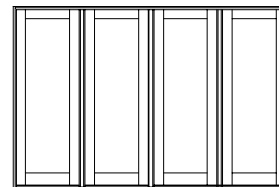
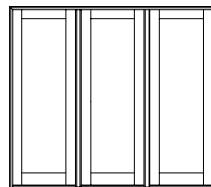
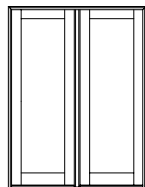
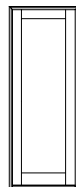

IN-SWING CALLOUT # S-1
OUT-SWING CALLOUT # SO-1

SS-1
SSO-1

SSS-1
SSSO-1

SSSS-1
SSSSO-1

GENERAL INFORMATION

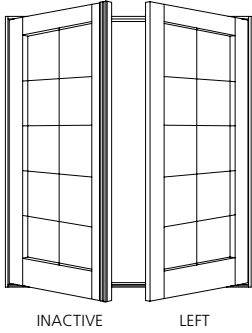

DIMENSIONAL DOORS

Clad In-Swing and Out-Swing patio doors may be specified as "dimensional", by adjusting the desired rough opening width or height in 1/4" increments from standard.

Clad In-Swing and Out-Swing patio doors are available in single, twin, triple and quad panel doors. Transoms are available to match the variety of door sizes.

OPERATION

Clad In-Swing and Out-Swing patio doors are available in a full range of operating styles. Single panel doors may be specified as stationary (non-venting) or can operate left or right. Center swing two- or three-panel doors are available with left or right operation. French doors feature two operating panels (one active, which opens first; and one inactive, which closes first), and are available in two-panel and four-panel styles. Configuration and handing is based on viewing the door from the interior.

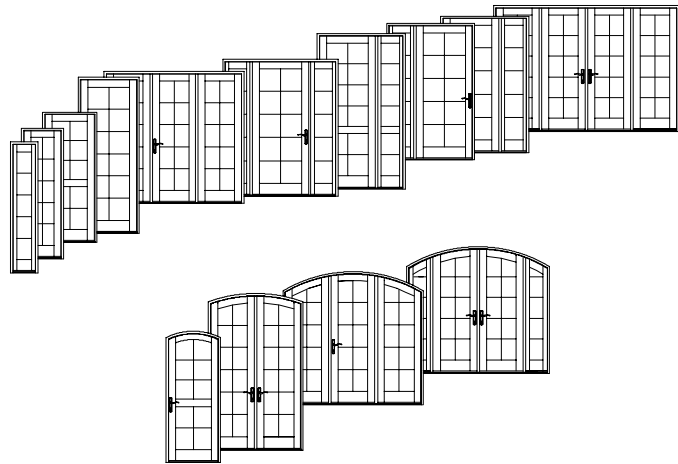

MULTIPLE ASSEMBLIES

Clad In-Swing and Out-Swing patio doors are available in a wide variety of multiple panel configurations from the factory, all of which are assembled with continuous sills. Clad In-Swing and Out-Swing patio doors may be mullied below, or beside other clad door and clad window products. Factory assembled mulls are limited in height (100"), width (150"), and a total area (75 square feet).



ELEVATION NOTES

ELEVATION DRAWINGS UTILIZE A LIMITED NUMBER OF PROJECTED LINES TO PRODUCE A RUDIMENTARY DRAWING INTENDED TO BE USED IN A SMALL GRAPHICAL SCALE. ELEVATIONS ARE VIEWED PERPENDICULAR FROM THE EXTERIOR OF THE STRUCTURE. IF MORE DIMENSIONS ARE NEEDED, USE THE SECTION DRAWINGS FOR MORE COMPLETE DEPICTIONS.

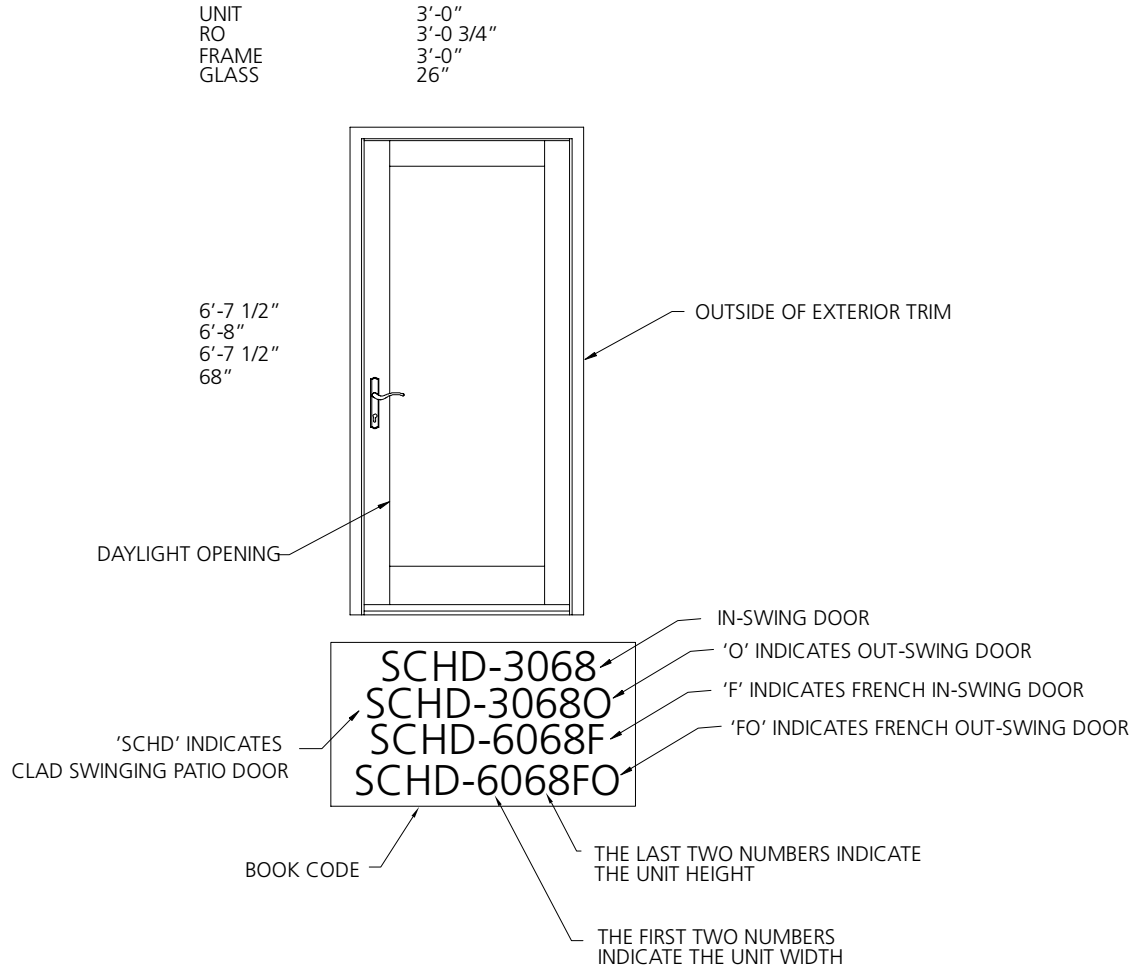

GENERAL SWINGING DOOR NOTES

1. CLAD SWINGING PATIO DOOR UNITS ARE AVAILABLE AS OPERATING OR FIXED UNITS.
2. UNIT ELEVATIONS ARE SHOWN WITHOUT EXTERIOR TRIM. UNIT SIZES & MASONRY OPENING DIMENSIONS WILL CHANGE WITH THE ADDITION OF EXTERIOR TRIM. SEE THE 'UNIT SIZING, ROUGH OPENINGS & MASONRY OPENINGS' PAGE FOR EXTERIOR TRIM EFFECTS.
3. OPERATING UNITS ARE AVAILABLE AS LEFT OR RIGHT HAND OPERATION.
4. HANDICAP SILL, 10 1/4" BOTTOM RAILS, INTERMEDIATE LOCK RAILS AND RAISED PANELS ARE AVAILABLE FOR ALL UNITS.

SINGLE SWING IN-SWING AND OUT-SWING PATIO DOORS

UNIT	1'-0"	1'-6"	2'-0"	2'-6"	5'-0"	7'-6"
RSO	1'-0 3/4"	1'-6 3/4"	2'-0 3/4"	2'-6 3/4"	5'-0 3/4"	7'-6 3/4"
FRAME	1'-0"	1'-6"	2'-0"	2'-6"	5'-0"	7'-6"
GLASS	7"	13"	16 3/4"	20"	20"	20"

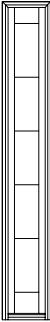
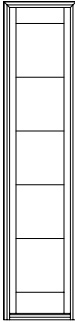
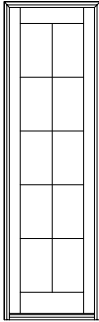
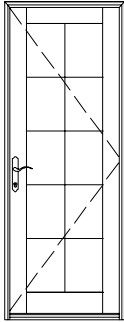
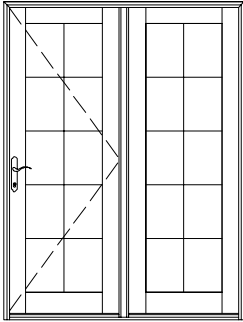
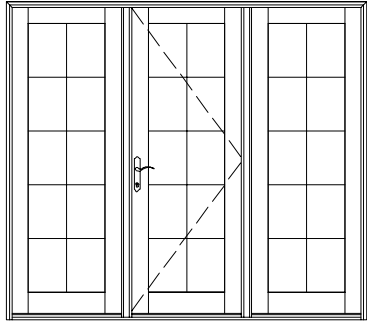
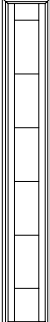
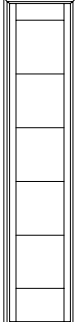
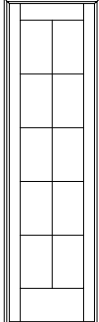
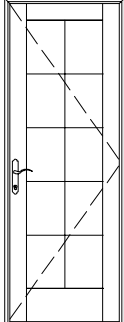
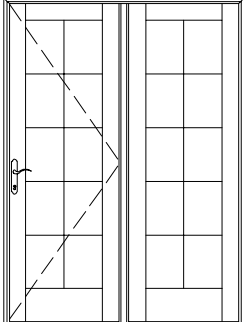
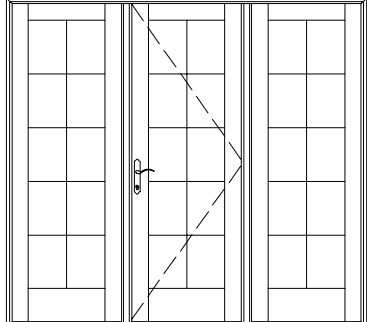
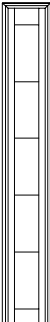
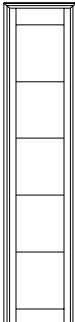
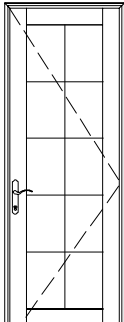
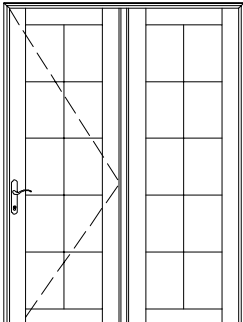
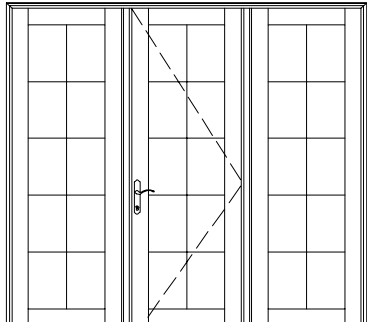
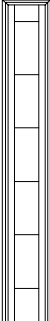
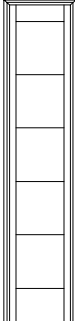
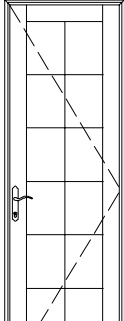
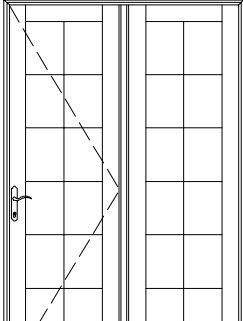
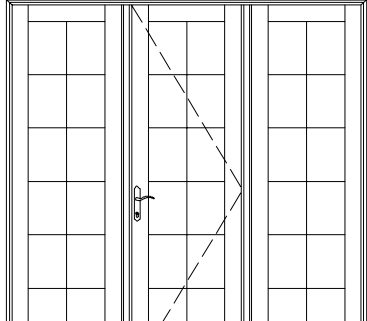
6'-7 1/2"						
	SCHD-1068 SCHD-10680	SCHD-1668 SCHD-16680	SCHD-2068 SCHD-20680	SCHD-2668 SCHD-26680	SCHD-5068 SCHD-50680	SCHD-7668 SCHD-76680
6'-10 1/2"						
	SCHD-10611 SCHD-106110	SCHD-16611 SCHD-166110	SCHD-20611 SCHD-206110	SCHD-26611 SCHD-266110	SCHD-50611 SCHD-506110	SCHD-76611 SCHD-766110
7'-2 1/2"						
	SCHD-1073 SCHD-10730	SCHD-1673 SCHD-16730	SCHD-2073 SCHD-20730	SCHD-2673 SCHD-26730	SCHD-5073 SCHD-50730	SCHD-7673 SCHD-76730
7'-11 1/2"						
	SCHD-1080 SCHD-10800	SCHD-1680 SCHD-16800	SCHD-2080 SCHD-20800	SCHD-2680 SCHD-26800	SCHD-5080 SCHD-50800	SCHD-7680 SCHD-76800

Note: See pages 14-10 and NO TAG for handing options. Other panel combinations may be specified.

SCALE: 1/4" = 1'

SINGLE SWING IN-SWING AND OUT-SWING PATIO DOORS

UNIT
RO
FRAME
GLASS

2'-9"
2'-9 3/4"
2'-9"
23"

5'-6"
5'-6 3/4"
5'-6"
23"

8'-3"
8'-3 3/4"
8'-3"
23"

6'-7 1/2"
6'-8"
6'-7 1/2"
68"

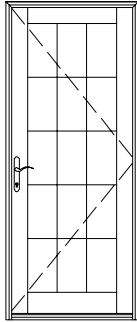

SCHD-2968
SCHD-29680

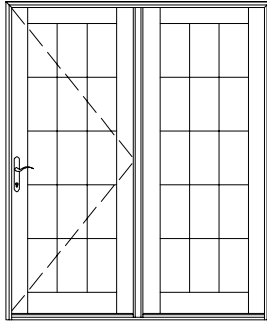

SCHD-5668
SCHD-56680

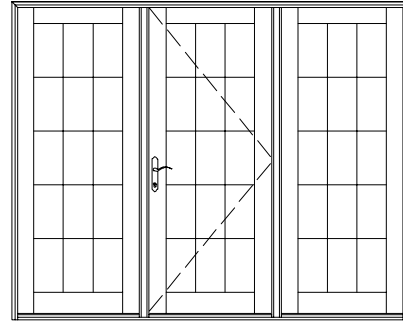

SCHD-8368
SCHD-83680

6'-10 1/2"
6'-11"
6'-10 1/2"
68"

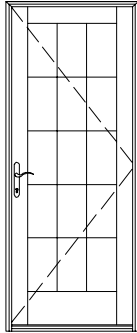

SCHD-29611
SCHD-296110

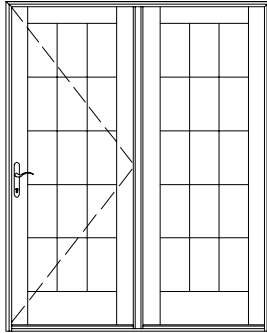

SCHD-56611
SCHD-566110

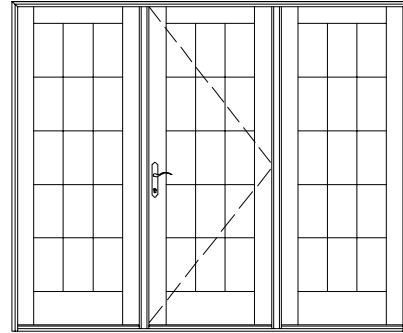

SCHD-83611
SCHD-836110

7'-2 1/2"
7'-3"
7'-2 1/2"
72"

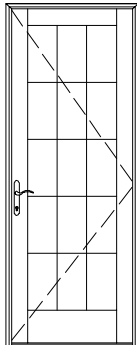

SCHD-2973
SCHD-29730

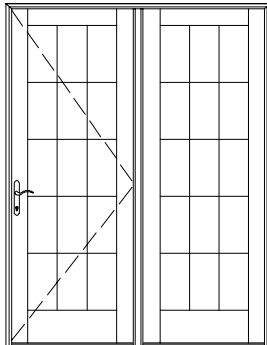

SCHD-5673
SCHD-56730

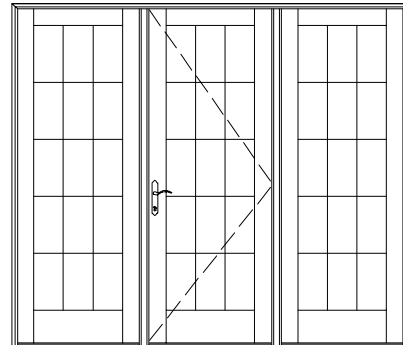

SCHD-8373
SCHD-83730

7'-11 1/2"
8'-0"
7'-11 1/2"
81"

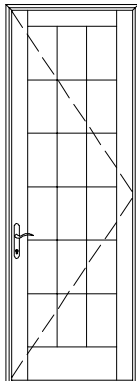

SCHD-2980
SCHD-29800

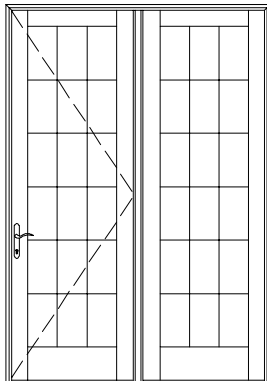

SCHD-5680
SCHD-56800

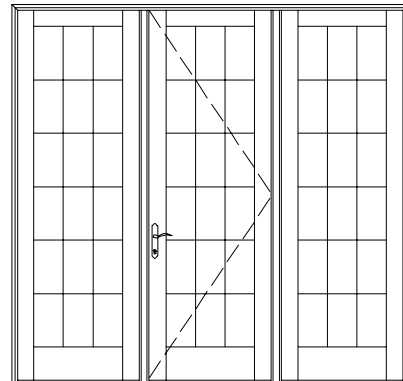

SCHD-8380
SCHD-83800

Note: See pages 14-10 and NO TAG for handing options. Other panel combinations may be specified.

SCALE: 1/4" = 1'

SINGLE SWING IN-SWING AND OUT-SWING PATIO DOORS

UNIT
RO
FRAME
GLASS

3'-0"
3'-0 3/4"
3'-0"
26"

6'-0"
6'-0 3/4"
6'-0"
26"

9'-0"
9'-0 3/4"
9'-0"
26"

6'-7 1/2"
6'-8"
6'-7 1/2"
68"

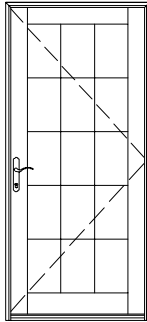

SCHD-3068
SCHD-3068O

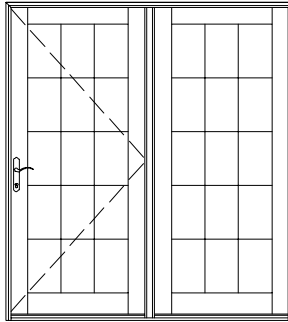

SCHD-6068
SCHD-6068O

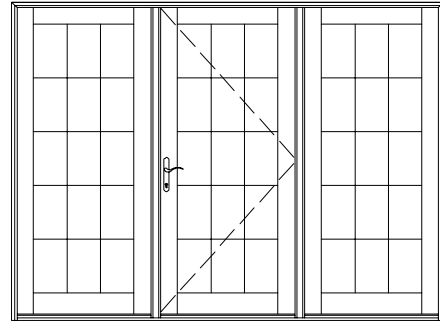

SCHD-9068
SCHD-9068O

6'-10 1/2"
6'-11"
6'-10 1/2"
68"

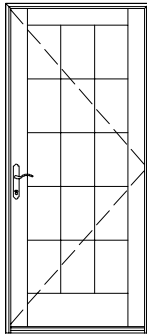

SCHD-30611
SCHD-30611O

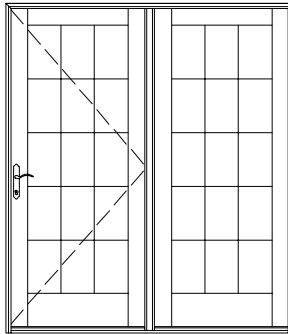

SCHD-60611
SCHD-60611O

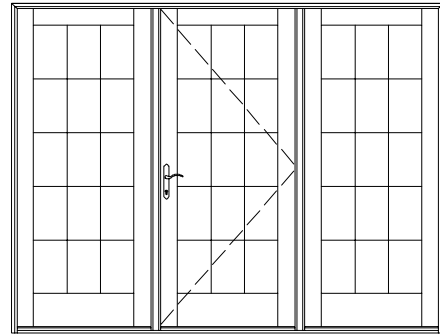

SCHD-90611
SCHD-90611O

7'-2 1/2"
7'-3"
7'-2 1/2"
72"

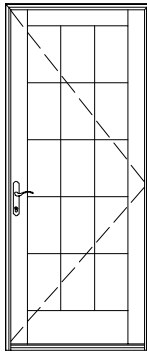

SCHD-3073
SCHD-3073O

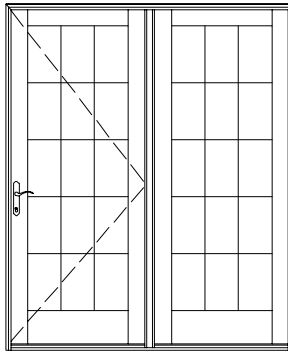

SCHD-6073
SCHD-6073O

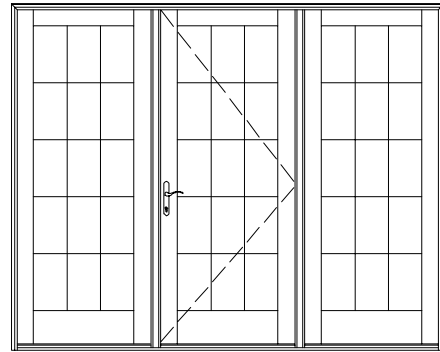

SCHD-9073
SCHD-9073O

7'-11 1/2"
8'-0"
7'-11 1/2"
81"

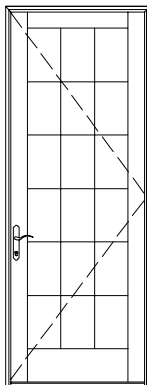

SCHD-3080
SCHD-3080O

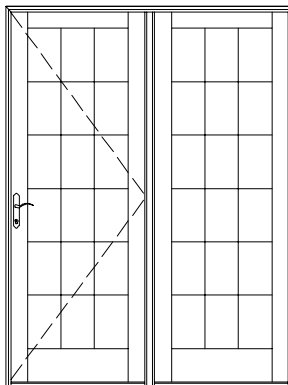

SCHD-6080
SCHD-6080O

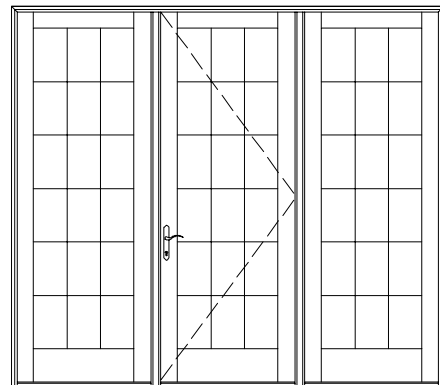

SCHD-9080
SCHD-9080O

Note: See pages 14-10 and NO TAG for handing options. Other panel combinations may be specified.

SCALE: 1/4" = 1'

4-PANEL SINGLE SWING IN-SWING AND OUT-SWING PATIO DOORS

UNIT
RO
FRAME
GLASS

10'-0"
10'-0 3/4"
10'-0"
20"

11'-0"
11'-0 3/4"
11'-0"
23"

6'-7 1/2"
6'-8"
6'-7 1/2"
68"

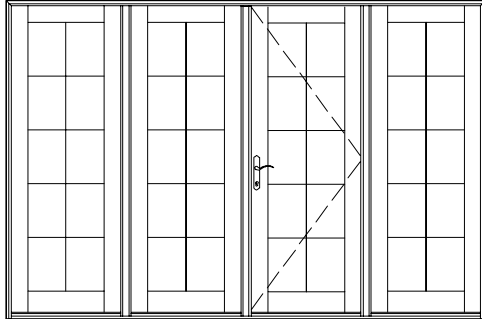

SCHD-10068
SCHD-100680

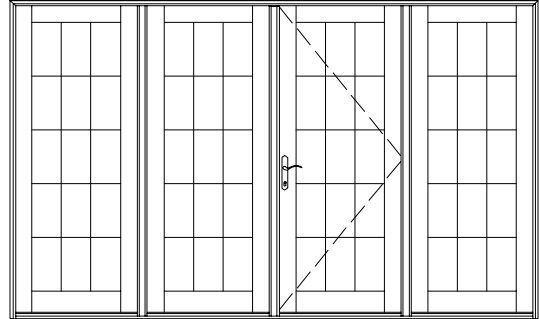

SCHD-11068
SCHD-110680

6'-10 1/2"
6'-11"
6'-10 1/2"
68"

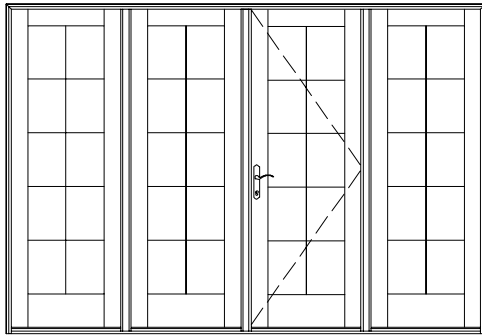

SCHD-100611
SCHD-1006110

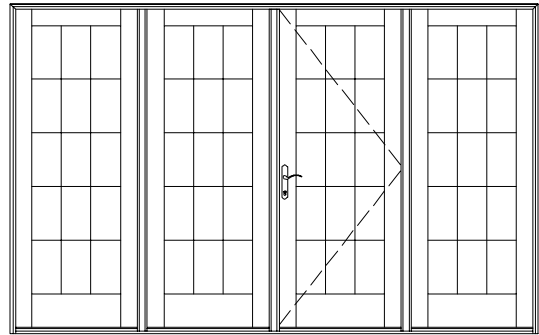

SCHD-110611
SCHD-1106110

7'-2 1/2"
7'-3"
7'-2 1/2"
72"

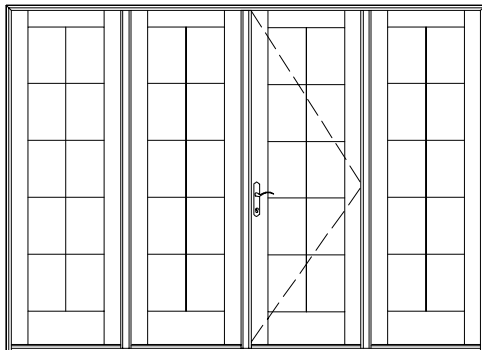

SCHD-10073
SCHD-100730

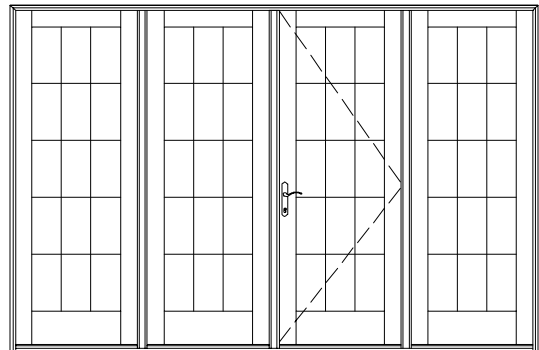

SCHD-11073
SCHD-110730

7'-11 1/2"
8'-0"
7'-11 1/2"
81"

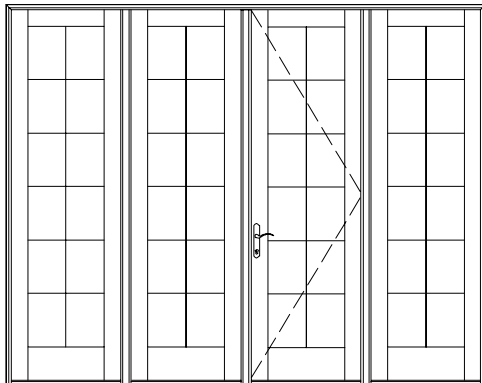

SCHD-10080
SCHD-100800

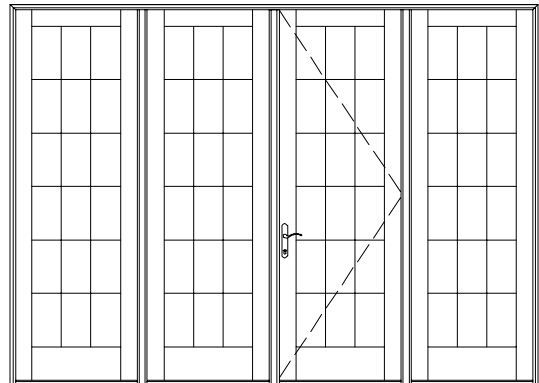

SCHD-11080
SCHD-110800

Note: See pages 14-10 and NO TAG for handing options. Other panel combinations may be specified.

SCALE: 1/4" = 1'

4-PANEL SINGLE SWING IN-SWING AND OUT-SWING PATIO DOORS

UNIT	12'-0"
RO	12'-0 3/4"
FRAME	12'-0"
GLASS	26"

6'-7 1/2"
6'-8"
6'-7 1/2"
68"

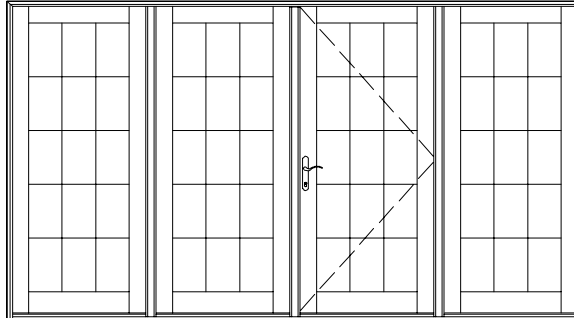

SCHD-12068
SCHD-12068O

6'-10 1/2"
6'-11"
6'-10 1/2"
68"

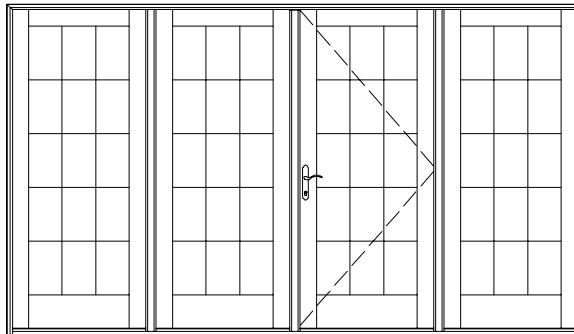

SCHD-120611
SCHD-120611O

7'-2 1/2"
7'-3"
7'-2 1/2"
72"

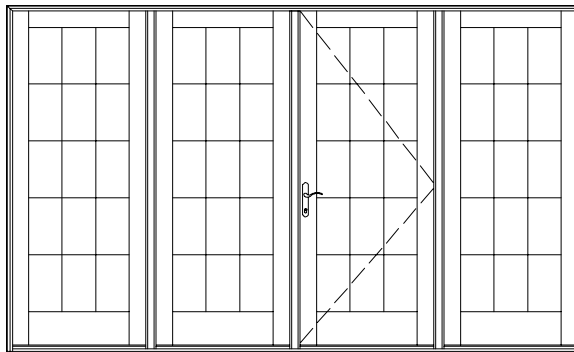

SCHD-12073
SCHD-12073O

7'-11 1/2"
8'-0"
7'-11 1/2"
81"

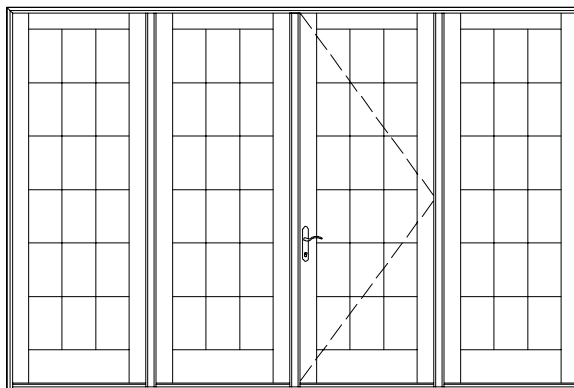

SCHD-12080
SCHD-12080O

Note: See pages 14-10 and NO TAG for handing options. Other panel combinations may be specified.

SCALE: 1/4" = 1'

SINGLE COMMERCIAL WIDTH IN-SWING AND OUT-SWING PATIO DOORS

UNIT
RO
FRAME
GLASS

3'-2 9/16"
3'-3 5/16"
3'-2 9/16"
28 9/16"

6'- 5 1/8"
6'- 5 7/8"
6'- 5 1/8"
28 9/16"

9'- 7 11/16"
9'- 8 7/16"
9'- 7 11/16"
28 9/16"

6'-7 1/2"
6'-8"
6'-7 1/2"
68"

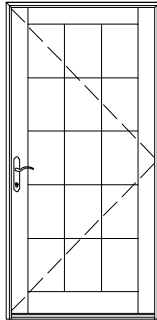

SCHED-30C68
SCHED-30C680

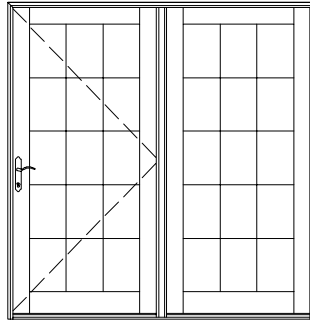

SCHED-60C68
SCHED-60C680

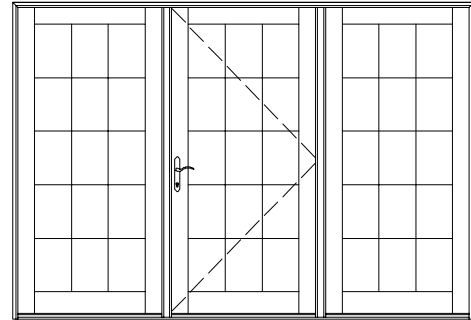

SCHED-90C68
SCHED-90C680

6'-10 1/2"
6'-11"
6'-10 1/2"
68"

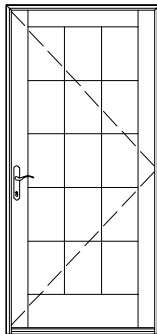

SCHED-30C611
SCHED-30C6110

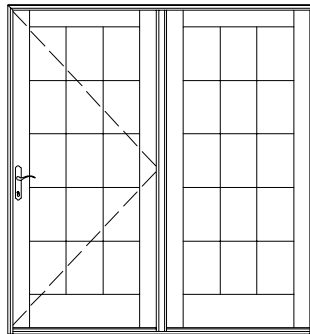

SCHED-60C611
SCHED-60C6110

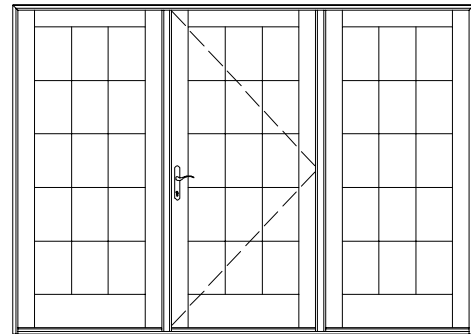

SCHED-90C611
SCHED-90C6110

7'-2 1/2"
7'-3"
7'-2 1/2"
72"

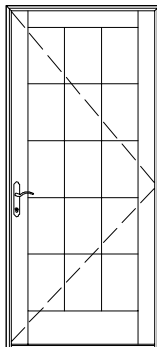

SCHED-30C73
SCHED-30C730

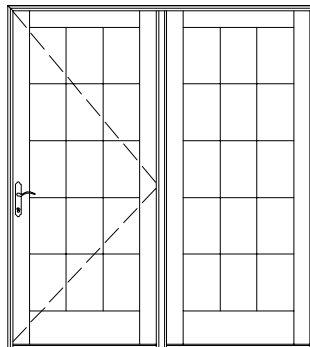

SCHED-60C73
SCHED-60C730

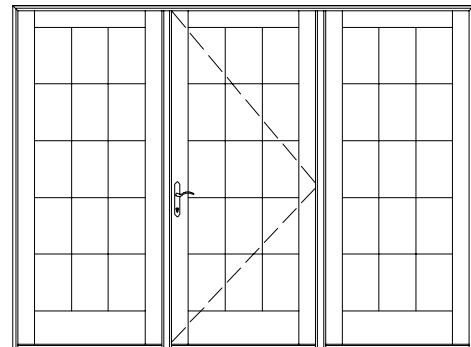

SCHED-90C73
SCHED-90C730

7'-11 1/2"
8'-0"
7'-11 1/2"
81"

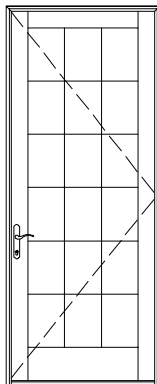

SCHED-30C80
SCHED-30C800

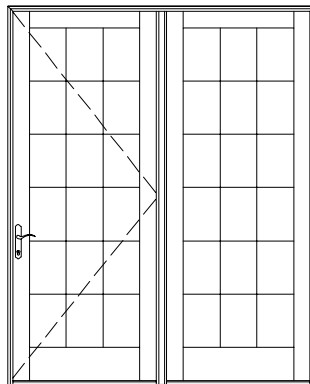

SCHED-60C80
SCHED-60C800

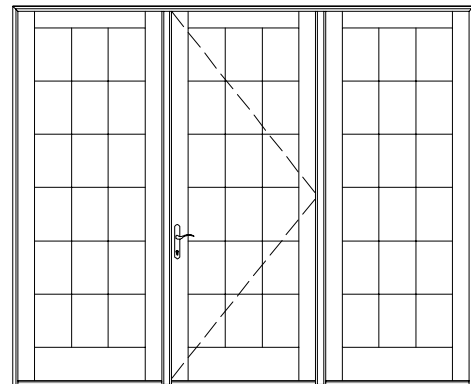

SCHED-90C80
SCHED-90C800

Note: See pages 14-10 and NO TAG for handing options. Other panel combinations may be specified.

SCALE: 1/4" = 1'

**SINGLE COMMERCIAL WIDTH IN-SWING AND OUT-SWING PATIO DOORS
WITH HANDICAP SILL**

These doors have shorter frame and rough opening heights due to the handicap sill.

UNIT
RO
FRAME
GLASS

3'-2 9/16"
3'-3 5/16"
3'-2 9/16"
28 9/16"

6'-5 1/8"
6'-5 7/8"
6'-5 1/8"
28 9/16"

9'-7 11/16"
9'-8 7/16"
9'-7 11/16"
28 9/16"

6'-6 11/16"
6'-7 3/16"
6'-6 11/16"
68"

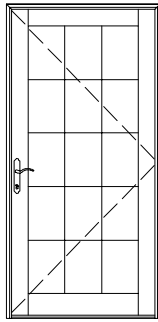

SCHD-30C68
SCHD-30C68O

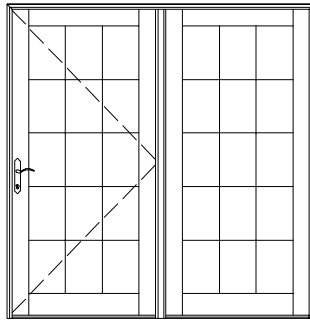

SCHD-60C68
SCHD-60C68O

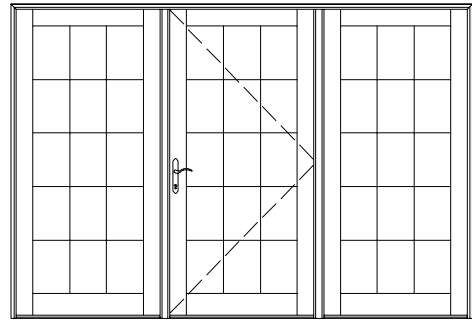

SCHD-90C68
SCHD-90C68O

6'-9 11/16"
6'-10 3/16"
6'-9 11/16"
68"

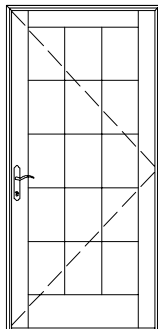

SCHD-30C611
SCHD-30C611O

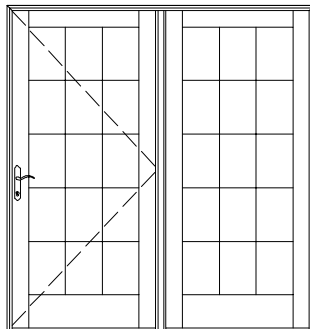

SCHD-60C611
SCHD-60C611O

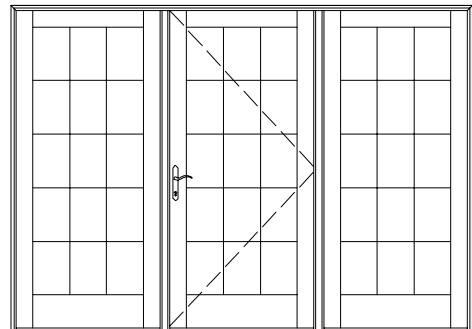

SCHD-90C611
SCHD-90C611O

7'-1 11/16"
7'-2 3/16"
7'-1 11/16"
72"

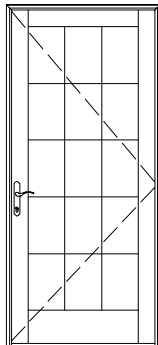

SCHD-30C73
SCHD-30C73O

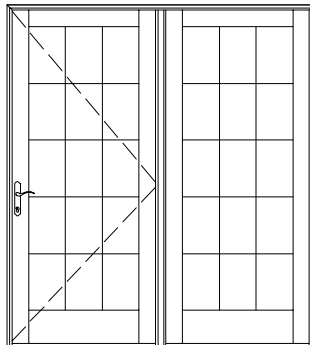

SCHD-60C73
SCHD-60C73O

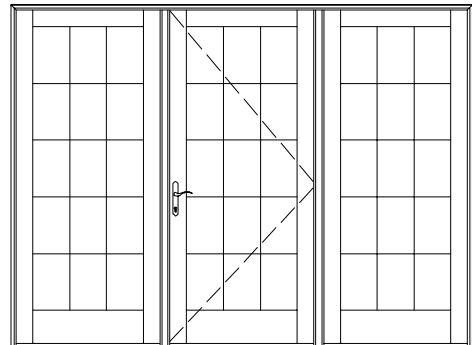

SCHD-90C73
SCHD-90C73O

7'-10 11/16"
7'-11 3/16"
7'-10 11/16"
81"

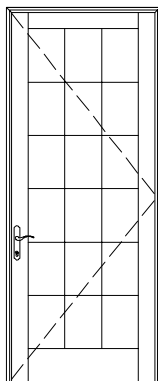

SCHD-30C80
SCHD-30C80O

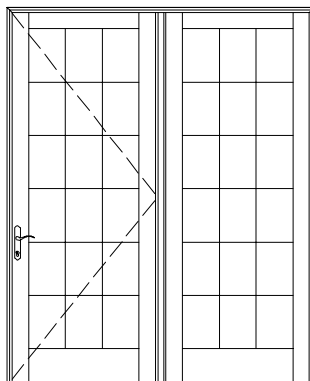

SCHD-60C80
SCHD-60C80O

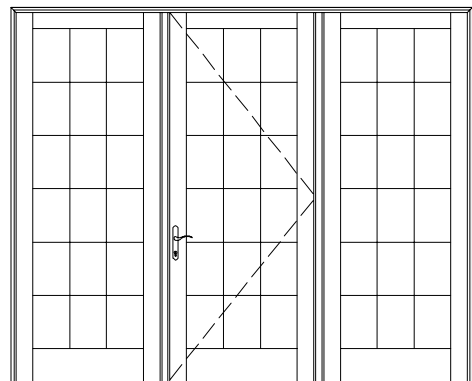

SCHD-90C80
SCHD-90C80O

Note: See pages 14-10 and NO TAG for handing options. Other panel combinations may be specified.

SCALE: 1/4" = 1'

FRENCH IN-SWING AND OUT-SWING PATIO DOORS

UNIT
RO
FRAME
GLASS

4'-0"
4'-0 3/4"
4'-0"
16 3/4"

8'-0"
8'-0 3/4"
8'-0"
16 3/4"

6'-7 1/2"
6'-8"
6'-7 1/2"
68"

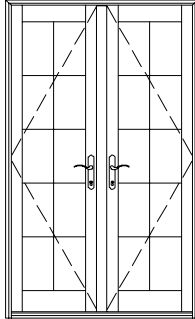

SCHD-4068F
SCHD-4068FO

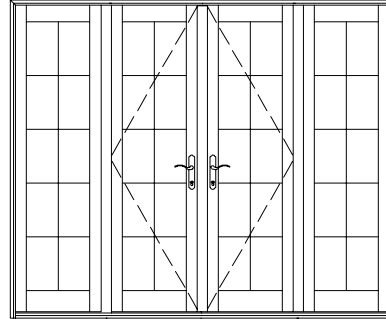

SCHD-8068F
SCHD-8068FO

6'-10 1/2"
6'-11"
6'-10 1/2"
68"

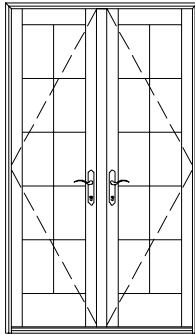

SCHD-40611F
SCHD-40611FO

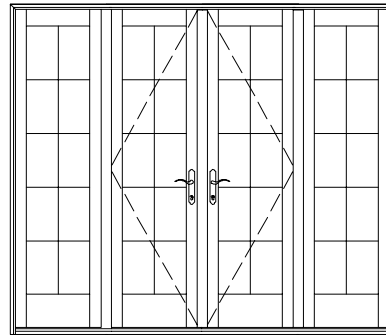

SCHD-80611F
SCHD-80611FO

7'-2 1/2"
7'-3"
7'-2 1/2"
72"

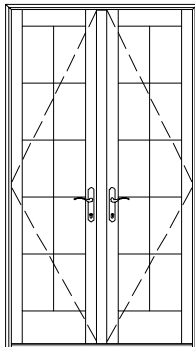

SCHD-4073F
SCHD-4073FO

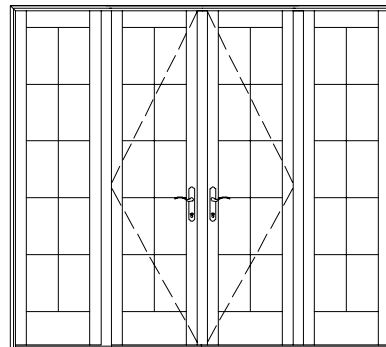

SCHD-8073F
SCHD-8073FO

7'-11 1/2"
8'-0"
7'-11 1/2"
81"

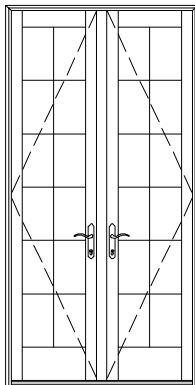

SCHD-4080F
SCHD-4080FO

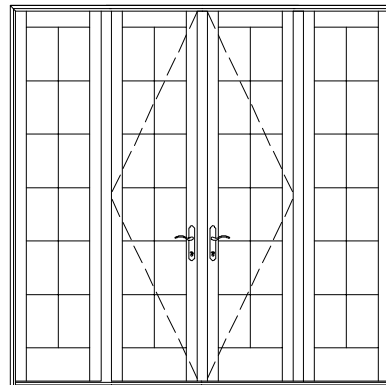

SCHD-8080F
SCHD-8080FO

Note: See pages 14-10 and NO TAG for handing options. Other panel combinations may be specified.

SCALE: 1/4" = 1'

FRENCH IN-SWING AND OUT-SWING PATIO DOORS

UNIT
RO
FRAME
GLASS

5'-0"
5'-0 3/4"
5'-0"
20"

10'-0"
10'-0 3/4"
10'-0"
20"

6'-7 1/2"
6'-8"
6'-7 1/2"
68"

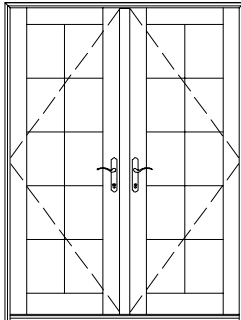

SCHD-5068F
SCHD-5068FO

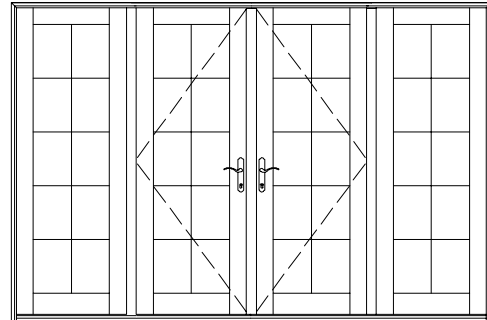

SCHD-1068F
SCHD-1068FO

6'-10 1/2"
6'-11"
6'-10 1/2"
68"

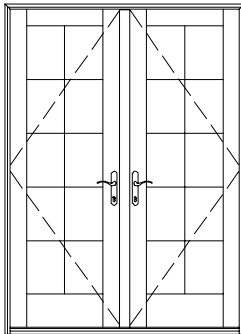

SCHD-50611F
SCHD-50611FO

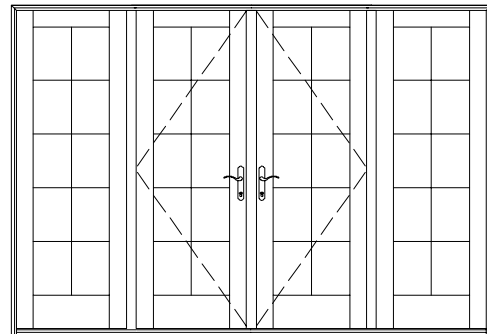

SCHD-100611F
SCHD-100611FO

7'-2 1/2"
7'-3"
7'-2 1/2"
72"

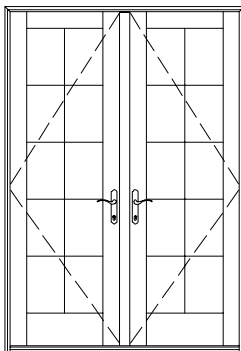

SCHD-5073F
SCHD-5073FO

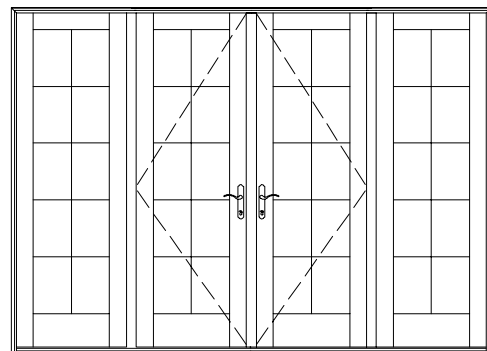

SCHD-10073F
SCHD-10073FO

7'-11 1/2"
8'-0"
7'-11 1/2"
81"

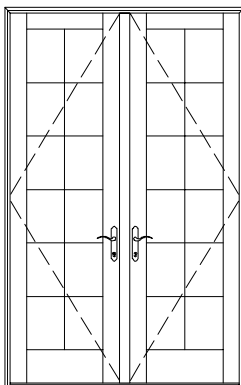

SCHD-5080F
SCHD-5080FO

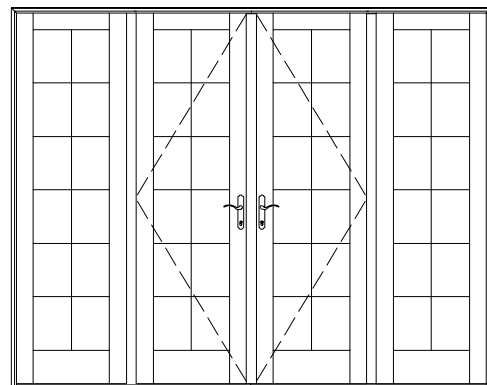

SCHD-10080F
SCHD-10080FO

Note: See pages 14-10 and NO TAG for handing options. Other panel combinations may be specified.

SCALE: 1/4" = 1'

FRENCH IN-SWING AND OUT-SWING PATIO DOORS

UNIT
RO
FRAME
GLASS

5'-6"
5'-6 3/4"
5'-6"
23"

11'-0"
11'-0 3/4"
11'-0"
23"

6'-7 1/2"
6'-8"
6'-7 1/2"
68"

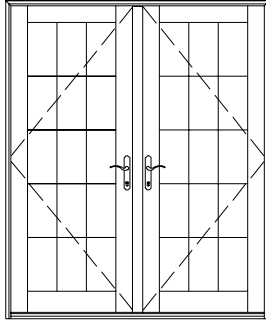

SCHD-5668F
SCHD-5668FO

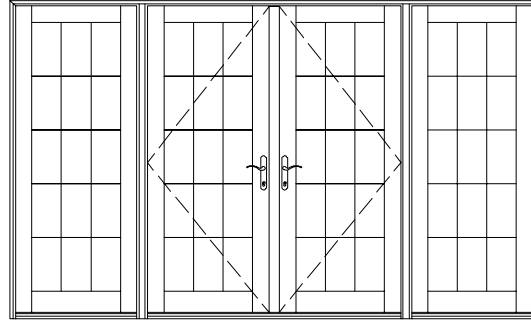

SCHD-11068F
SCHD-11068FO

6'-10 1/2"
6'-11"
6'-10 1/2"
68"

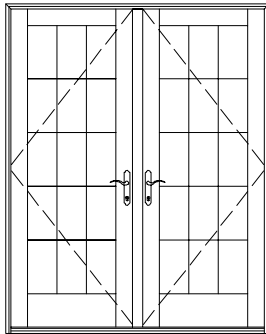

SCHD-56611F
SCHD-56611FO

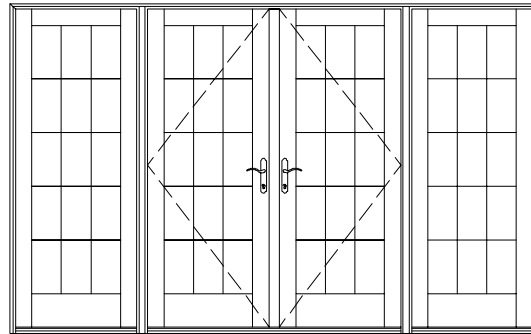

SCHD-110611F
SCHD-110611FO

7'-2 1/2"
7'-3"
7'-2 1/2"
72"

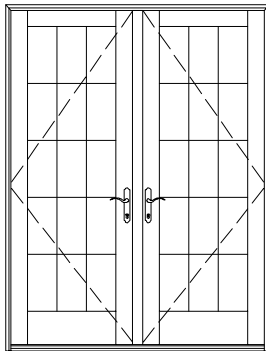

SCHD-5673F
SCHD-5673FO

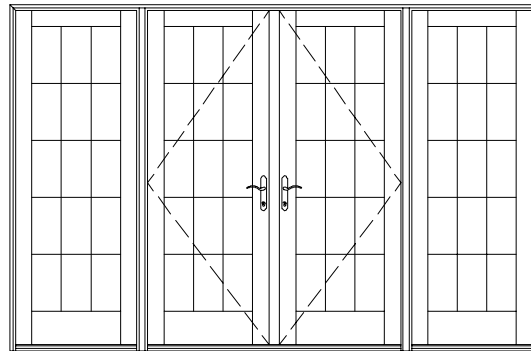

SCHD-11073F
SCHD-11073FO

7'-11 1/2"
8'-0"
7'-11 1/2"
81"

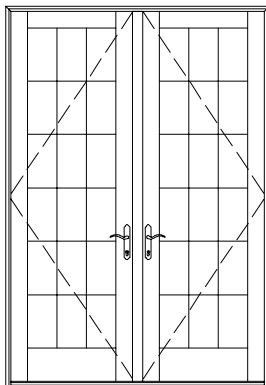

SCHD-5680F
SCHD-5680FO

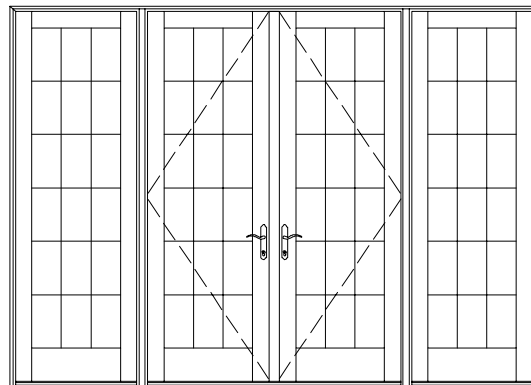

SCHD-11080F
SCHD-11080FO

Note: See pages 14-10 and NO TAG for handing options. Other panel combinations may be specified.

SCALE: 1/4" = 1'

FRENCH IN-SWING AND OUT-SWING PATIO DOORS

UNIT
RO
FRAME
GLASS

6'-0"
6'-0 3/4"
6'-0"
26"

12'-0"
12'-0 3/4"
12'-0"
26"

6'-7 1/2"
6'-8"
6'-7 1/2"
68"

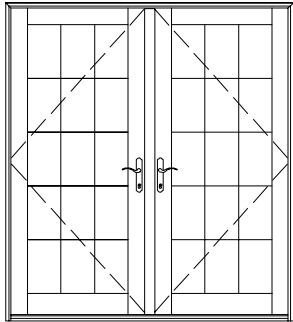

SCHD-6068F
SCHD-6068FO

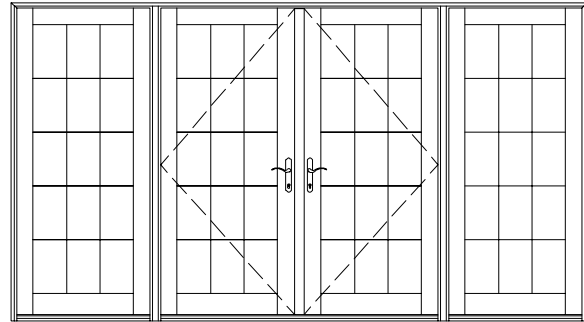

SCHD-12068F
SCHD-12068FO

6'-10 1/2"
6'-11"
6'-10 1/2"
68"

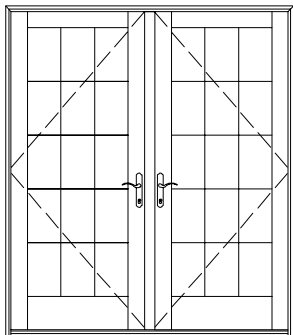

SCHD-60611F
SCHD-60611FO

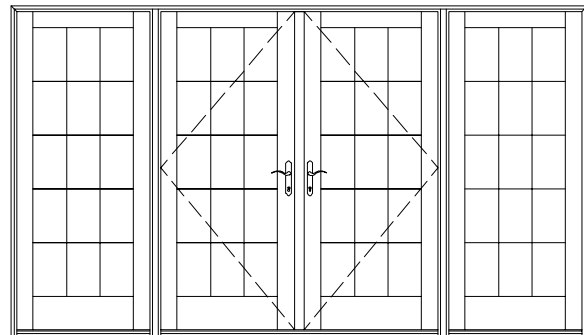

SCHD-120611F
SCHD-120611FO

7'-2 1/2"
7'-3"
7'-2 1/2"
72"

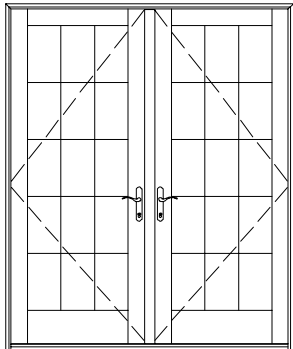

SCHD-6073F
SCHD-6073FO

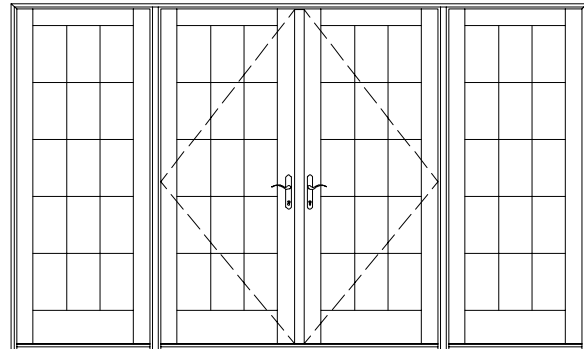

SCHD-12073F
SCHD-12073FO

7'-11 1/2"
8'-0"
7'-11 1/2"
81"

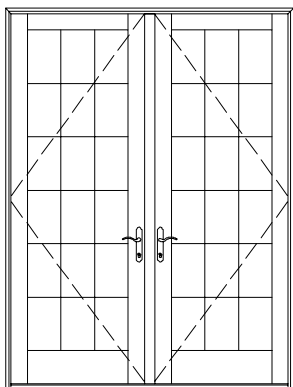

SCHD-6080F
SCHD-6080FO

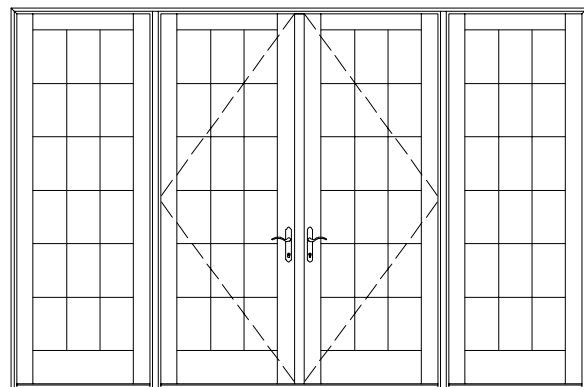

SCHD-12080F
SCHD-12080FO

Note: See pages 14-10 and NO TAG for handing options. Other panel combinations may be specified.

SCALE: 1/4" = 1'

SINGLE SWING IN-SWING AND OUT-SWING PATIO DOORS
WITH CLAD PINE BOTTOM PANEL

UNIT
RO
FRAME
GLASS

1'-6"
1'-6 3/4"
1'-6"
13"

2'-6"
2'-6 3/4"
2'-6"
20"

5'-0"
5'-0 3/4"
5'-0"
20"

7'-6"
7'-6 3/4"
7'-6"
20"

6'-7 1/2"
6'-8"
6'-7 1/2"
38 1/16"

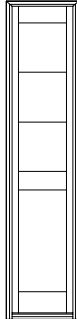

SCHD-1668
SCHD-1668O

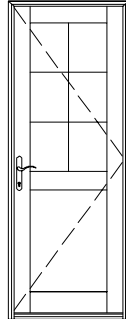

SCHD-2668
SCHD-2668O

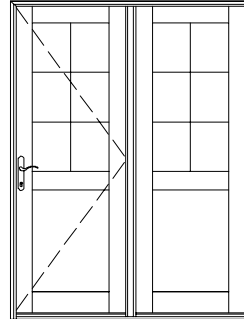

SCHD-5068
SCHD-5068O

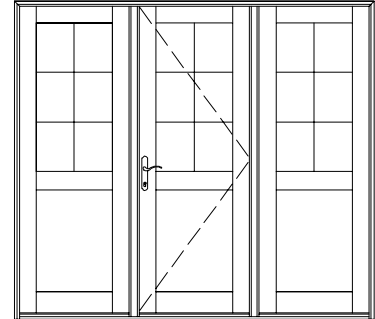

SCHD-7668
SCHD-7668O

6'-10 1/2"
6'-11"
6'-10 1/2"
38 1/16"

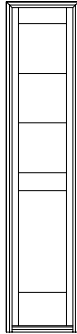

SCHD-16611
SCHD-16611O

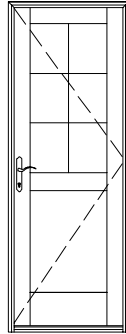

SCHD-26611
SCHD-26611O

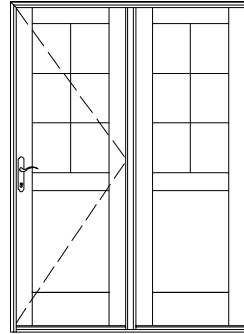

SCHD-50611
SCHD-50611O

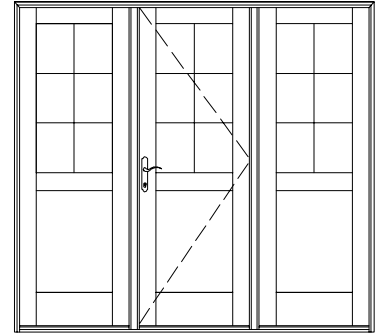

SCHD-76611
SCHD-76611O

7'-2 1/2"
7'-3"
7'-2 1/2"
42 1/16"

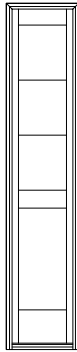

SCHD-1673
SCHD-1673O

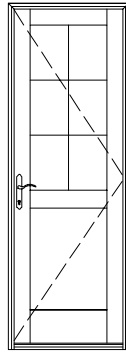

SCHD-2673
SCHD-2673O

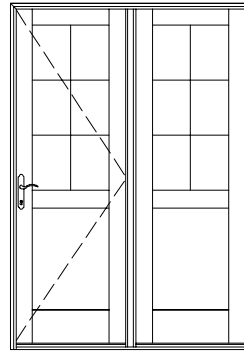

SCHD-5073
SCHD-5073O

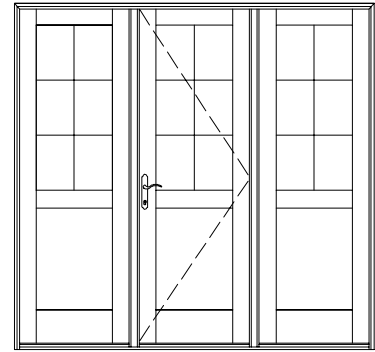

SCHD-7673
SCHD-7673O

7'-11 1/2"
8'-0"
7'-11 1/2"
51 1/16"

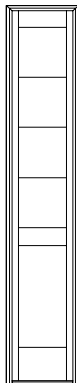

SCHD-1680
SCHD-1680O

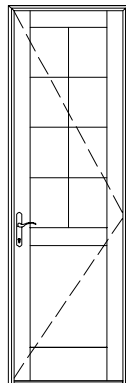

SCHD-2680
SCHD-2680O

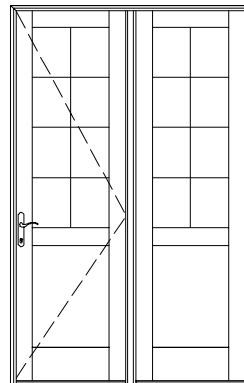

SCHD-5080
SCHD-5080O

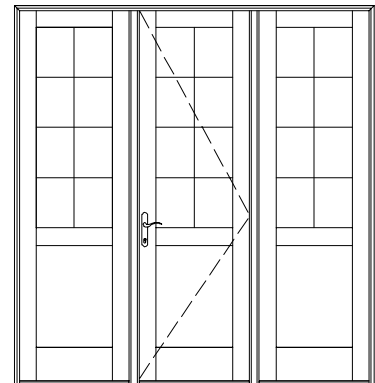

SCHD-7680
SCHD-7680O

Note: See pages 14-10 and NO TAG for handing options. Other panel combinations may be specified.
See pages 13-81 and 13-86 for section detail.

SCALE: 1/4" = 1'

SINGLE SWING IN-SWING AND OUT-SWING PATIO DOORS
WITH CLAD PINE BOTTOM PANEL

UNIT
RO
FRAME
GLASS

2'-9"
2'-9 3/4"
2'-9"
23"

5'-6"
5'-6 3/4"
5'-6"
23"

8'-3"
8'-3 3/4"
8'-3"
23"

6'-7 1/2"
6'-8"
6'-7 1/2"
38 1/16"

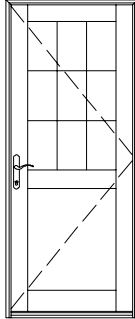

SCHD-2968
SCHD-29680

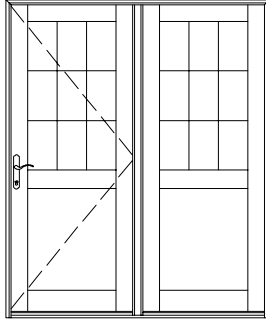

SCHD-5668
SCHD-56680

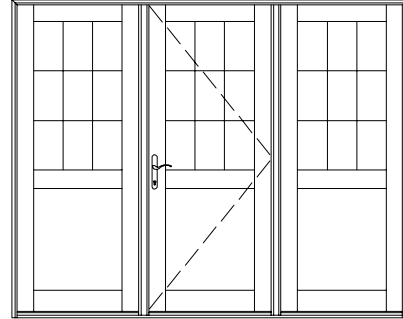

SCHD-8368
SCHD-83680

6'-10 1/2"
6'-11"
6'-10 1/2"
38 1/16"

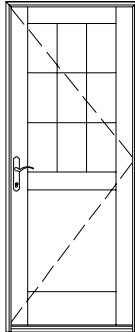

SCHD-29611
SCHD-296110

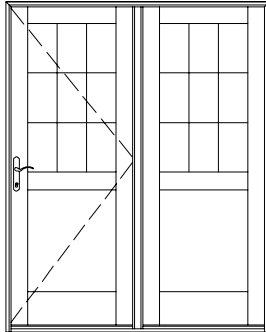

SCHD-56611
SCHD-566110

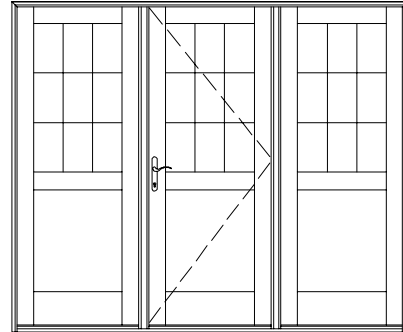

SCHD-83611
SCHD-836110

7'-2 1/2"
7'-3"
7'-2 1/2"
42 1/16"

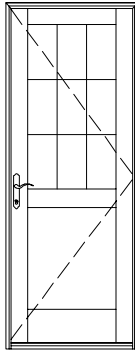

SCHD-2973
SCHD-29730

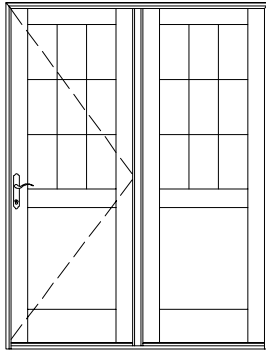

SCHD-5673
SCHD-56730

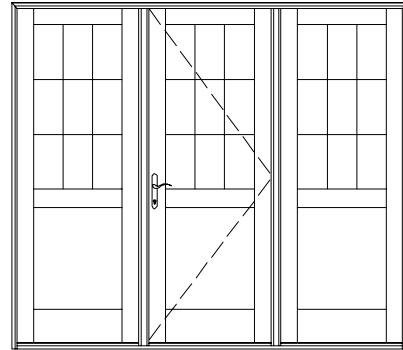

SCHD-8373
SCHD-83730

7'-11 1/2"
8'-0"
7'-11 1/2"
51 1/16"

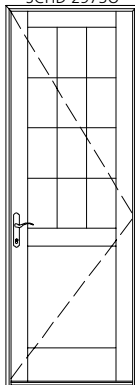

SCHD-2980
SCHD-29800

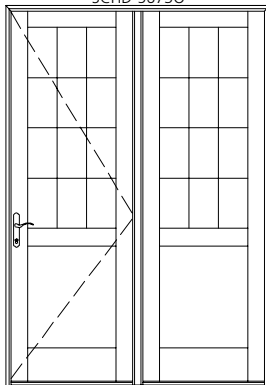

SCHD-5680
SCHD-56800

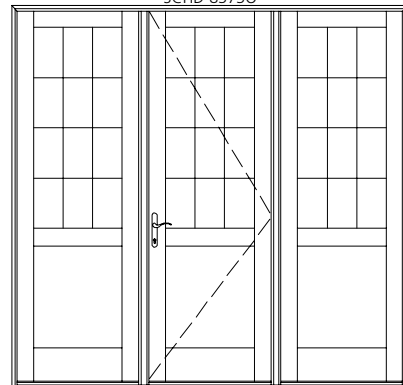

SCHD-8380
SCHD-83800

Note: See pages 14-10 and NO TAG for handing options. Other panel combinations may be specified.
See pages 13-81 and 13-86 for section detail.

SCALE: 1/4" = 1'

SINGLE SWING IN-SWING AND OUT-SWING PATIO DOORS
WITH CLAD PINE BOTTOM PANEL

UNIT
RO
FRAME
GLASS

3'-0"
3'-0 3/4"
3'-0"
26"

6'-0"
6'-0 3/4"
6'-0"
26"

9'-0"
9'-0 3/4"
9'-0"
26"

6'-7 1/2"
6'-8"
6'-7 1/2"
38 1/16"

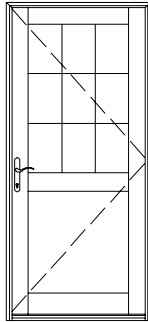

SCHD-3068
SCHD-3068O

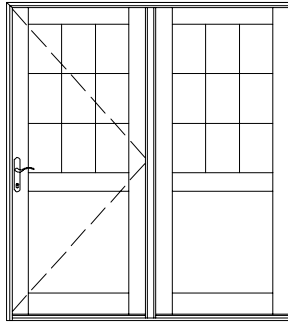

SCHD-6068
SCHD-6068O

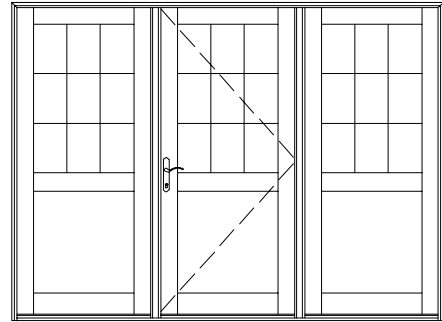

SCHD-9068
SCHD-9068O

6'-10 1/2"
6'-11"
6'-10 1/2"
38 1/16"

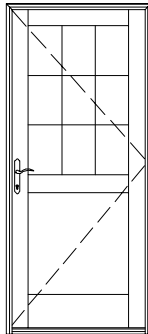

SCHD-30611
SCHD-30611O

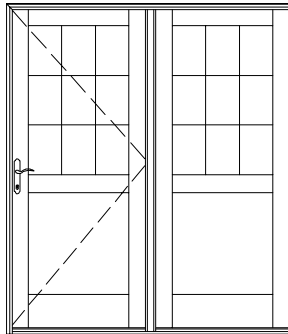

SCHD-60611
SCHD-60611O

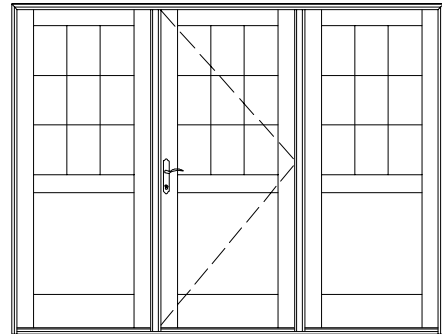

SCHD-90611
SCHD-90611O

7'-2 1/2"
7'-3"
7'-2 1/2"
42 1/16"

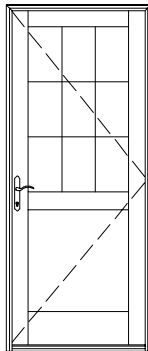

SCHD-3073
SCHD-3073O

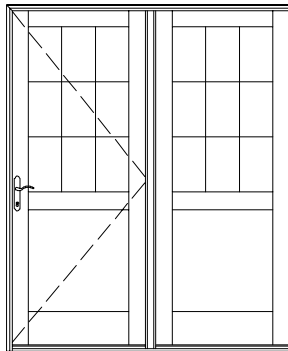

SCHD-6073
SCHD-6073O

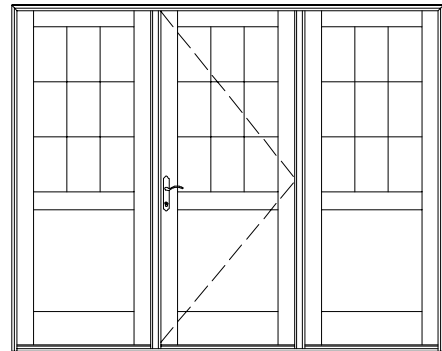

SCHD-9073
SCHD-9073O

7'-11 1/2"
8'-0"
7'-11 1/2"
51 1/16"

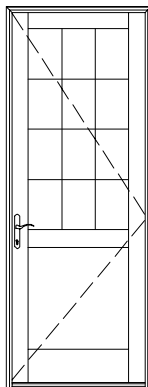

SCHD-3080
SCHD-3080O

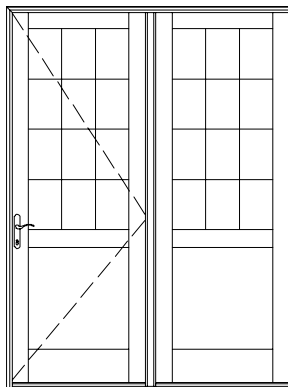

SCHD-6080
SCHD-6080O

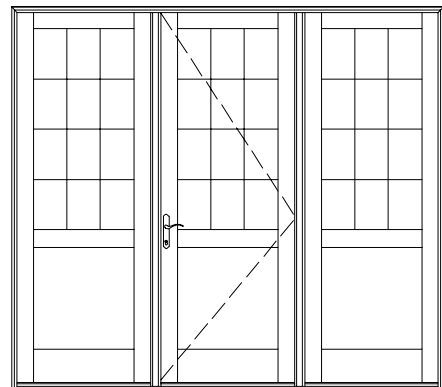

SCHD-9080
SCHD-9080O

Note: See pages 14-10 and NO TAG for handing options. Other panel combinations may be specified.
See pages 13-81 and 13-86 for section detail.

SCALE: 1/4" = 1'

**SINGLE COMMERCIAL WIDTH IN-SWING AND OUT-SWING PATIO DOORS
WITH CLAD PINE BOTTOM PANEL**

UNIT
RO
FRAME
GLASS

3'-2 9/16"
3'-3 5/16"
3'-2 9/16"
28 9/16"

6'-5 1/8"
6'-5 7/8"
6'-5 1/8"
28 9/16"

9'-7 11/16"
9'-8 7/16"
9'-7 11/16"
28 9/16"

6'-7 1/2"
6'-8"
6'-7 1/2"
38 1/16"

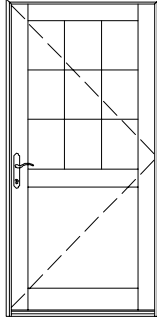

SCHD-30C68
SCHD-30C680

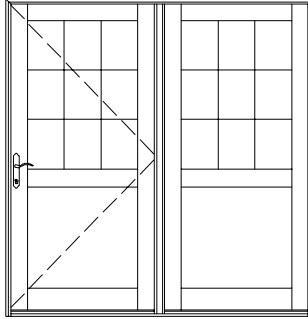

SCHD-60C68
SCHD-60C680

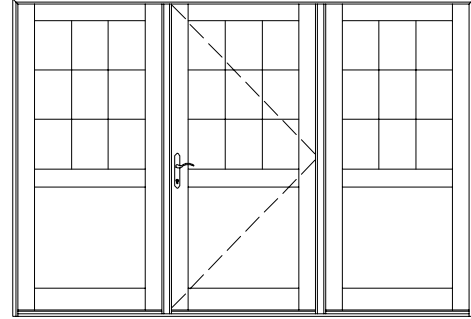

SCHD-90C68
SCHD-90C680

6'-10 1/2"
6'-11"
6'-10 1/2"
38 1/16"

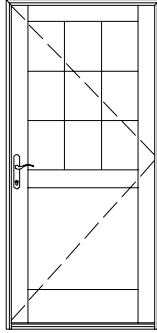

SCHD-30C611
SCHD-30C6110

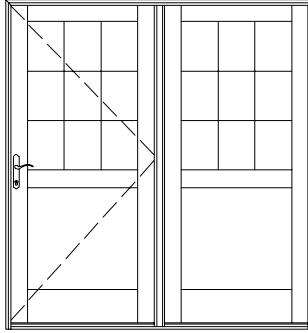

SCHD-60C611
SCHD-60C6110

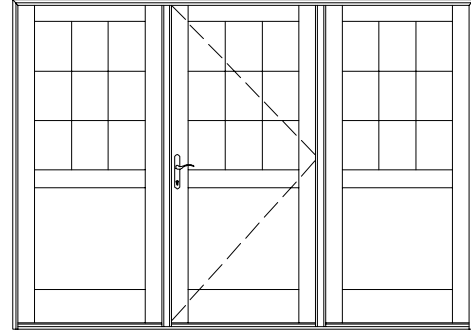

SCHD-90C611
SCHD-90C6110

7'-2 1/2"
7'-3"
7'-2 1/2"
42 1/16"

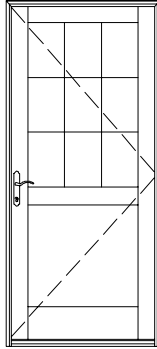

SCHD-30C73
SCHD-30C730

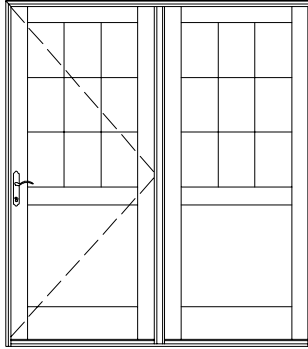

SCHD-60C73
SCHD-60C730

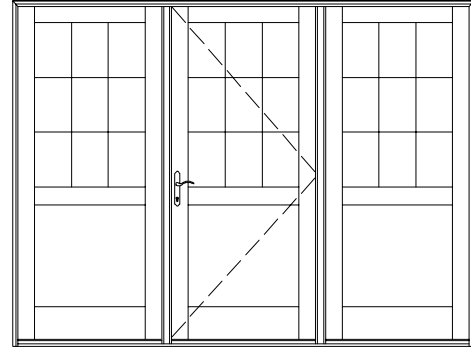

SCHD-90C73
SCHD-90C730

7'-11 1/2"
8'-0"
7'-11 1/2"
51 1/16"

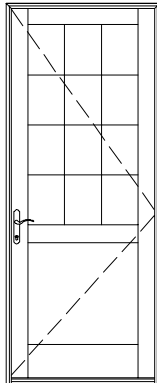

SCHD-30C80
SCHD-30C800

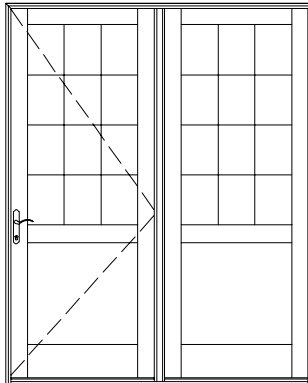

SCHD-60C80
SCHD-60C800

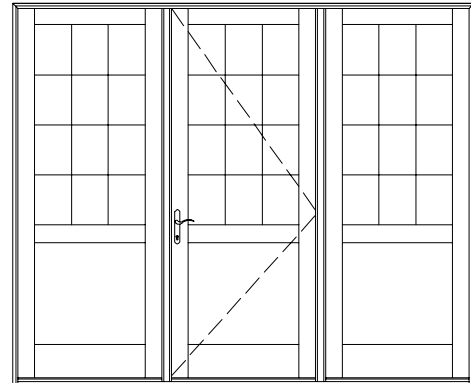

SCHD-90C80
SCHD-90C800

Note: See pages 14-10 and NO TAG for handing options. Other panel combinations may be specified.
See pages 13-81 and 13-86 for section detail.

SCALE: 1/4" = 1'

SINGLE SWING IN-SWING SECTOR TOP PATIO DOORS

UNIT
RO
FRAME
GLASS

2'-6"
2'-6 3/4"
2'-6"
20"

5'-0"
5'-0 3/4"
5'-0"
20"

LEG
5'-8 1/2"
MAX DROP 11"

6'-7 1/2"
6'-8"
6'-7 1/2"
68"

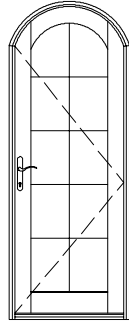

SCHED-2668 SEG TOP

LEG
5'-9 1/2"
MAX DROP 10"

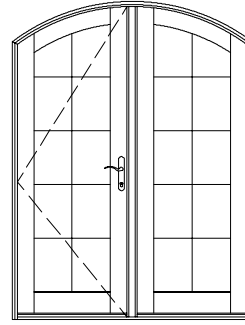

SCHED-5068 SEG TOP

LEG
5'-11 1/2"
MAX DROP 11"

6'-10 1/2"
6'-11"
6'-10 1/2"
68"

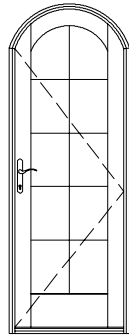

SCHED-26611 SEG TOP

LEG
6'-0 1/2"
MAX DROP 10"

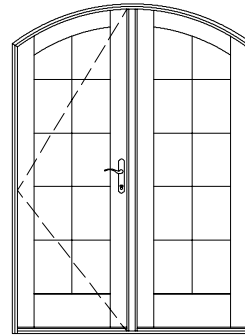

SCHED-50611 SEG TOP

LEG
6'-3 1/2"
MAX DROP 11"

7'-2 1/2"
7'-3"
7'-2 1/2"
72"

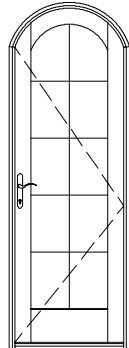

SCHED-2673 SEG TOP

LEG
6'-4 1/2"
MAX DROP 10"

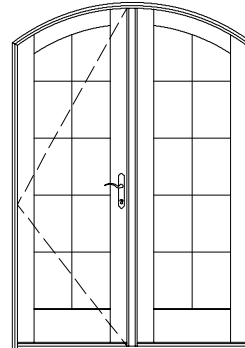

SCHED-5073 SEG TOP

LEG
7'-0 1/2"
MAX DROP 11"

7'-11 1/2"
8'-0"
7'-11 1/2"
81"

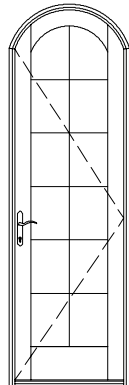

SCHED-2680 SEG TOP

LEG
7'-1 1/2"
MAX DROP 10"

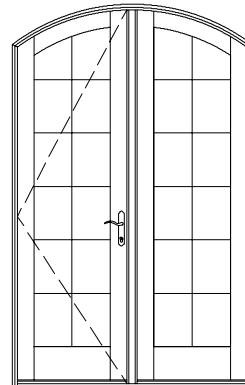

SCHED-5080 SEG TOP

Note: Not available in Out-Swing. Other swings may be specified.
3 & 4 Panel Segment doors are available, contact JELD-WEN for assistance.
Elevations show maximum drop.

SCALE: 1/4" = 1'

SINGLE SWING IN-SWING SECTOR TOP PATIO DOORS

UNIT
RO
FRAME
GLASS

2'-9"
2'-9 3/4"
2'-9"
23"

5'-6"
5'-6 3/4"
5'-6"
23"

LEG
5'-8 1/2"
MAX DROP 11"

6'-7 1/2"
6'-8"
6'-7 1/2"
68"

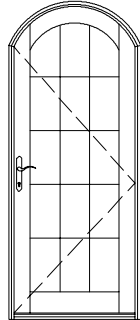

SCHED-2968 SEG TOP

LEG
5'-9 1/2"
MAX DROP 10"

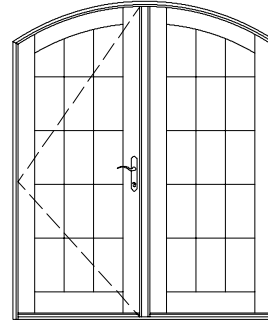

SCHED-5668 SEG TOP

LEG
5'-11 1/2"
MAX DROP 11"

6'-10 1/2"
6'-11"
6'-10 1/2"
68"

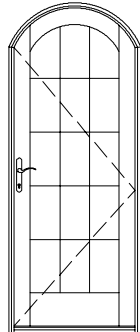

SCHED-2961 SEG TOP

LEG
6'-0 1/2"
MAX DROP 10"

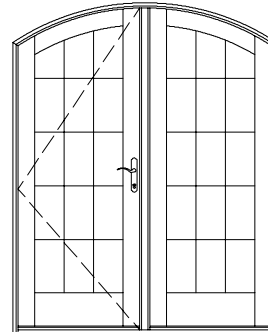

SCHED-5661 SEG TOP

LEG
6'-3 1/2"
MAX DROP 11"

7'-2 1/2"
7'-3"
7'-2 1/2"
72"

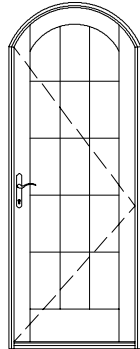

SCHED-2973 SEG TOP

LEG
6'-4 1/2"
MAX DROP 10"

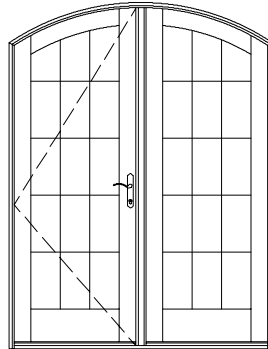

SCHED-5673 SEG TOP

LEG
7'-0 1/2"
MAX DROP 11"

7'-11 1/2"
8'-0"
7'-11 1/2"
81"

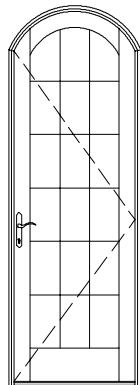

SCHED-2980 SEG TOP

LEG
7'-1 1/2"
MAX DROP 10"

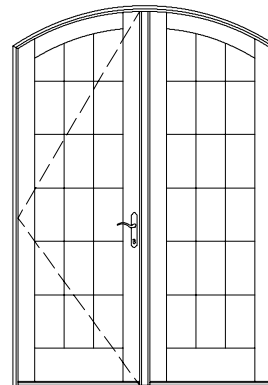

SCHED-5680 SEG TOP

Note: Not available in Out-Swing. Other swings may be specified.
3 & 4 Panel Segment doors are available, contact JELD-WEN for assistance.
Elevations show maximum drop.

SCALE: 1/4" = 1'

SINGLE SWING IN-SWING SECTOR TOP PATIO DOORS

**UNIT
RO
FRAME
GLASS**

3'-0"
3'-0 3/4"
3'-0"
26"

6'-0"
6'-0 3/4"
6'-0"
26"

LEG
5'-8 1/2"
MAX DROP 11"

LEG
5'-9 1/2"
MAX DROP 10"

6'-7 1/2"
6'-8"
6'-7 1/2"
68"

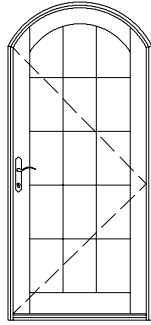

SCHED-3068 SEG TOP

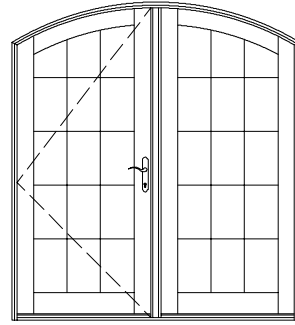

SCHED-6068 SEG TOP

LEG
5'-11 1/2"
MAX DROP 11"

LEG
6'-0 1/2"
MAX DROP 10"

6'-10 1/2"
6'-11"
6'-10 1/2"
68"

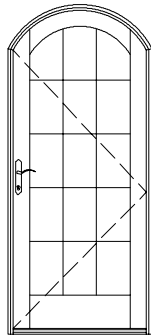

SCHED-30611 SEG TOP

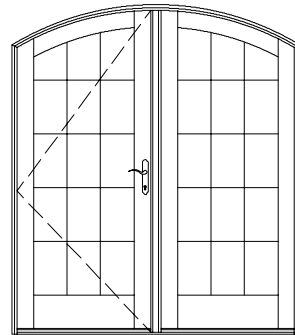

SCHED-60611 SEG TOP

LEG
6'-3 1/2"
MAX DROP 11"

LEG
6'-4 1/2"
MAX DROP 10"

7'-2 1/2"
7'-3"
7'-2 1/2"
72"

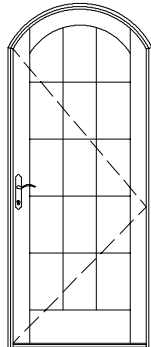

SCHED-3073 SEG TOP

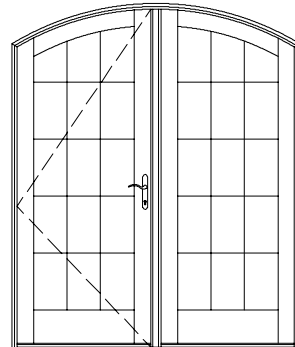

SCHED-6073 SEG TOP

LEG
7'-0 1/2"
MAX DROP 11"

LEG
7'-1 1/2"
MAX DROP 10"

7'-11 1/2"
8'-0"
7'-11 1/2"
81"

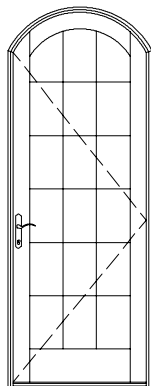

SCHED-3080 SEG TOP

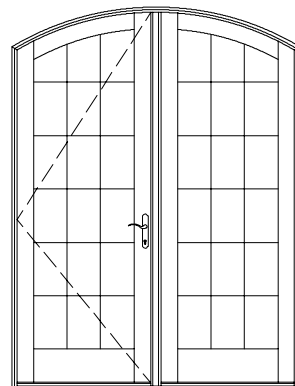

SCHED-6080 SEG TOP

Note: Not available in Out-Swing. Other swings may be specified.
3 & 4 Panel Segment doors are available, contact JELD-WEN for assistance.
Elevations show maximum drop.

SCALE: 1/4" = 1'

SINGLE SWING COMMERCIAL WIDTH IN-SWING SECTOR TOP PATIO DOORS

UNIT
RO
FRAME
GLASS

3'-2 9/16"
3'-3 5/16"
3'-2 9/16"
28 9/16"

6'-5 1/8"
6'-5 7/8"
6'-5 1/8"
28 9/16"

LEG
5'-8 1/2"
MAX DROP 11"

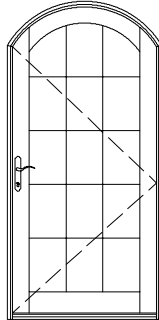

SCHD-30C68 SEG TOP

LEG
5'-9 1/2"
MAX DROP 10"

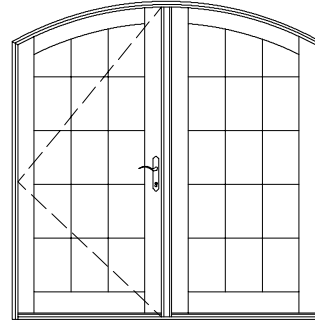

SCHD-60C68 SEG TOP

6'-7 1/2"
6'-8"
6'-7 1/2"
68"

LEG
5'-11 1/2"
MAX DROP 11"

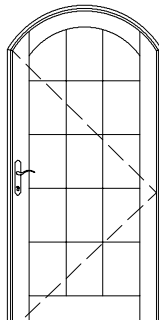

SCHD-30C611 SEG TOP

LEG
6'-0 1/2"
MAX DROP 10"

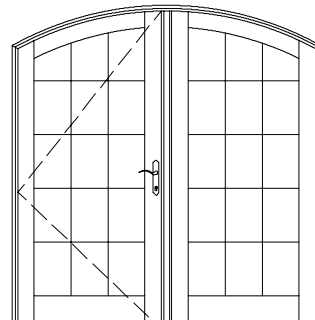

SCHD-60C611 SEG TOP

6'-10 1/2"
6'-11"
6'-10 1/2"
68"

LEG
6'-3 1/2"
MAX DROP 11"

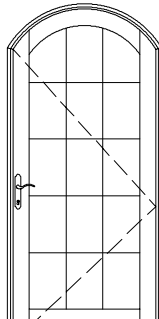

SCHD-30C73 SEG TOP

LEG
6'-4 1/2"
MAX DROP 10"

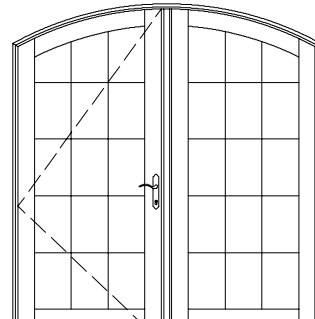

SCHD-60C73 SEG TOP

7'-2 1/2"
7'-3"
7'-2 1/2"
72"

LEG
7'-0 1/2"
MAX DROP 11"

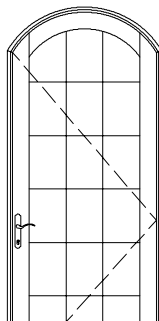

SCHD-30C80 SEG TOP

LEG
7'-1 1/2"
MAX DROP 10"

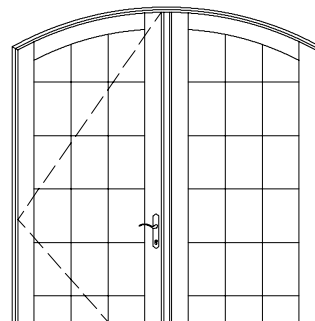

SCHD-60C80 SEG TOP

Note: Not available in Out-Swing. Other swings may be specified.
3 & 4 Panel Segment doors are available, contact JELD-WEN for assistance.
Elevations show maximum drop.

SCALE: 1/4" = 1'

FRENCH IN-SWING SECTOR TOP PATIO DOORS

UNIT
RSO
FRAME
GLASS

4'-0"
4'-0 3/4"
4'-0"
16 3/4"

5'-0"
5'-0 3/4"
5'-0"
20"

5'-6"
5'-6 3/4"
5'-6"
23"

LEG
5'-10"
MAX DROP 10"

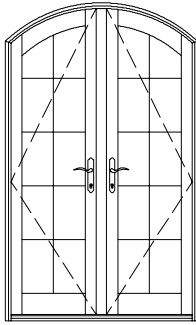

SCHD-4068F SEG TOP

LEG
5'-9 1/2"
MAX DROP 10"

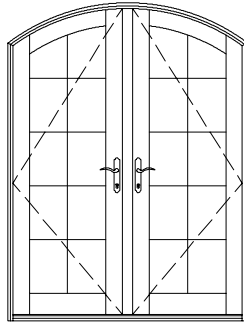

SCHD-5068F SEG TOP

LEG
5'-9 1/2"
MAX DROP 10"

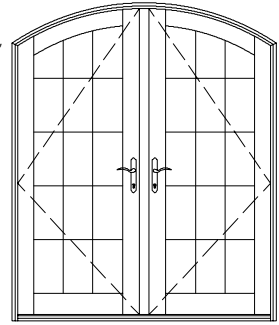

SCHD-5668F SEG TOP

6'-7 1/2"
6'-8"
6'-7 1/2"
68"

LEG
6'-1"
MAX DROP 9 1/2"

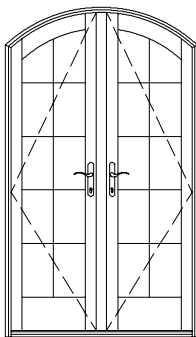

SCHD-40611F SEG TOP

LEG
6'-0 1/2"
MAX DROP 10"

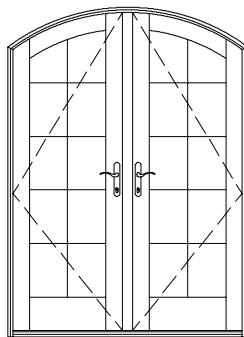

SCHD-50611F SEG TOP

LEG
6'-0 1/2"
MAX DROP 10"

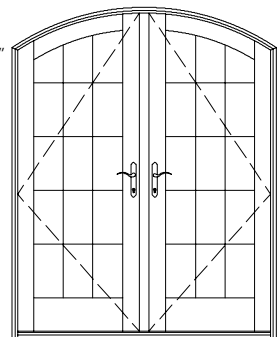

SCHD-5611F SEG TOP

6'-10 1/2"
6'-11"
6'-10 1/2"
68"

LEG
6'-5"
MAX DROP 9 1/2"

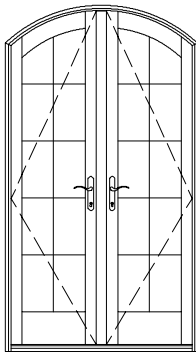

SCHD-4073F SEG TOP

LEG
6'-4 1/2"
MAX DROP 10"

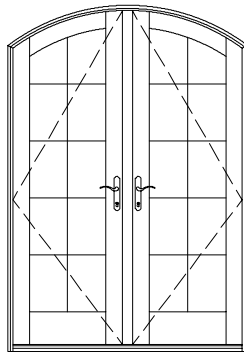

SCHD-5073F SEG TOP

LEG
6'-4 1/2"
MAX DROP 10"

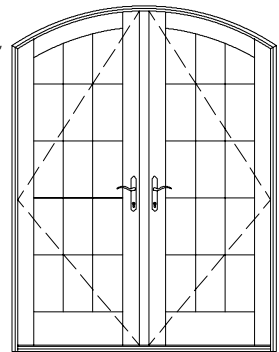

SCHD-5673F SEG TOP

7'-2 1/2"
7'-3"
7'-2 1/2"
72"

LEG
7'-2"
MAX DROP 9 1/2"

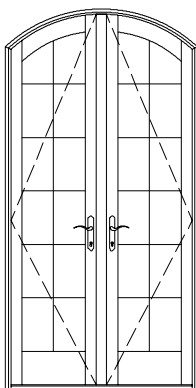

SCHD-4080F SEG TOP

LEG
7'-1 1/2"
MAX DROP 10"

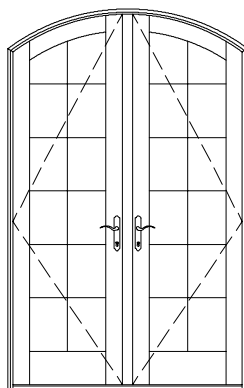

SCHD-5080F SEG TOP

LEG
7'-1 1/2"
MAX DROP 10"

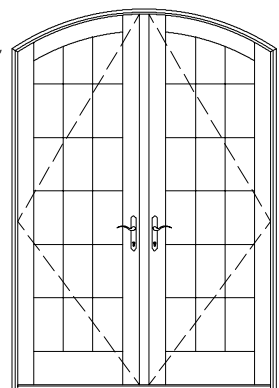

SCHD-5680F SEG TOP

Note: Not available in Out-Swing. Other swings may be specified.
3 & 4 Panel Segment doors are available, contact JELD-WEN for assistance.
Elevations show maximum drop.

SCALE: 1/4" = 1'

FRENCH AND FRENCH COMMERCIAL IN-SWING SECTOR TOP PATIO DOORS

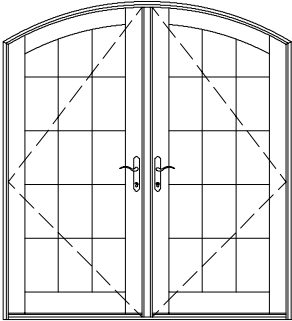
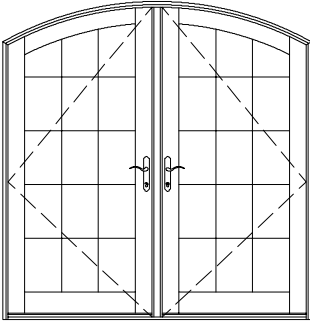
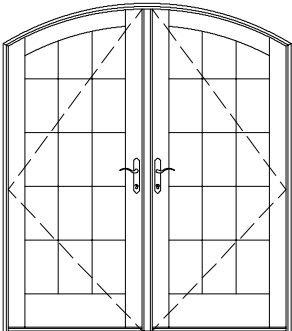
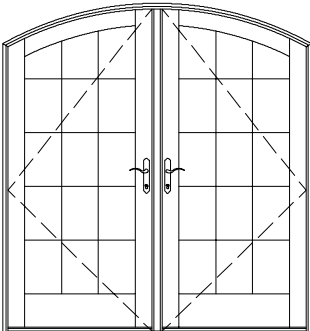
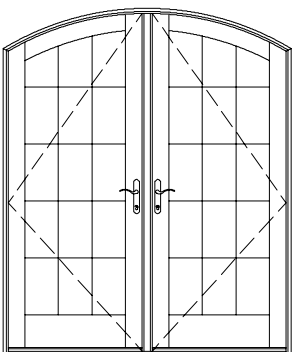
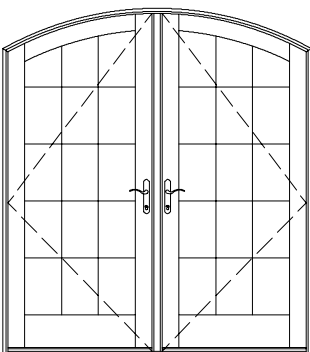
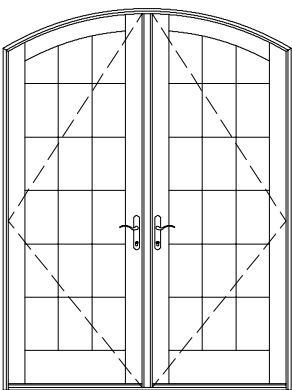
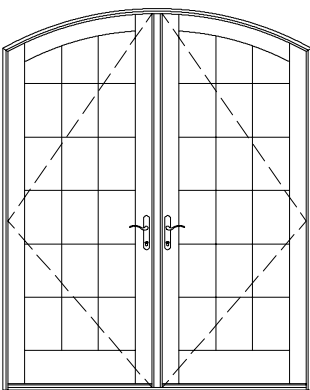
FRENCH		FRENCH COMMERCIAL	
UNIT RSO FRAME GLASS	6'-0" 6'-0 3/4" 6'-0" 26"	UNIT RSO FRAME GLASS	6'- 5 1/8" 6'- 5 7/8" 6'- 5 1/8" 28 9/16"
LEG 5'-9 1/2" MAX DROP 10" 6'-7 1/2" 6'-8" 6'-7 1/2" 68"		LEG 5'-9 1/2" MAX DROP 10"	
LEG 6'-0 1/2" MAX DROP 10" 6'-10 1/2" 6'-11" 6'-10 1/2" 68"		LEG 6'-0 1/2" MAX DROP 10"	
LEG 6'-4 1/2" MAX DROP 10" 7'-2 1/2" 7'-3" 7'-2 1/2" 72"		LEG 6'-4 1/2" MAX DROP 10"	
LEG 7'-1 1/2" MAX DROP 10" 7'-11 1/2" 8'-0" 7'-11 1/2" 81"		LEG 7'-1 1/2" MAX DROP 10"	

Note: Sector Top Doors not available in Out-Swing. Other swings may be specified.
 3 & 4 Panel Segment doors are available, contact JELD-WEN for assistance.
 Elevations show maximum drop.

SCALE: 1/4" = 1'

9-0 SINGLE SWING IN-SWING PATIO DOORS

UNIT
RSO
FRAME
GLASS

2'-6"
2'-6 3/4"
2'-6"
20"

2'-9"
2'-9 3/4"
2'-9"
23"

3'-0"
3'-0 3/4"
3'-0"
26"

8'-11 1/2"
9'-0"
8'-11 1/2"
93"

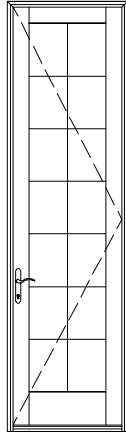

SCHED-2690

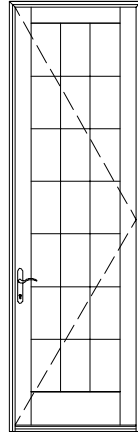

SCHED-2990

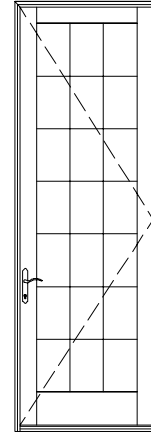

SCHED-3090

UNIT
RSO
FRAME
GLASS

5'-0"
5'-0 3/4"
5'-0"
20"

5'-6"
5'-6 3/4"
5'-6"
23"

6'-0"
6'-0 3/4"
6'-0"
26"

8'-11 1/2"
9'-0"
8'-11 1/2"
93"

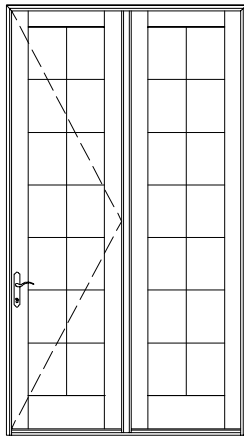

SCHED-5090

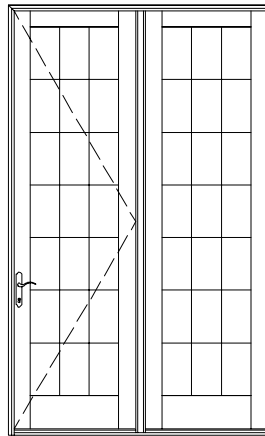

SCHED-5690

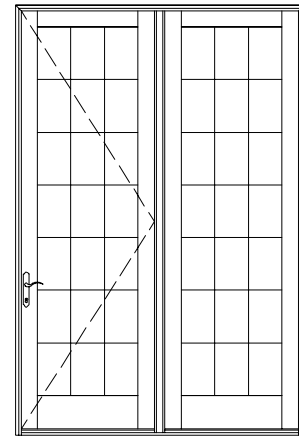

SCHED-6090

Note: Other swings may be specified.
Clad 9-0 & 10-0 high doors are not available as 3 panel and are not available as Out-Swing.

SCALE: 1/4" = 1'

10-0 SINGLE SWING IN-SWING PATIO DOORS

UNIT
RSO
FRAME
GLASS

2'-6"
2'-6 3/4"
2'-6"
20"

2'-9"
2'-9 3/4"
2'-9"
23"

3'-0"
3'-0 3/4"
3'-0"
26"

9'-11 1/2"
10'-0"
9'-11 1/2"
105"

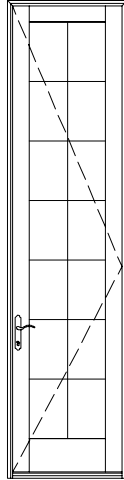

SCHED-26100

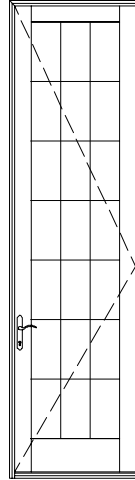

SCHED-29100

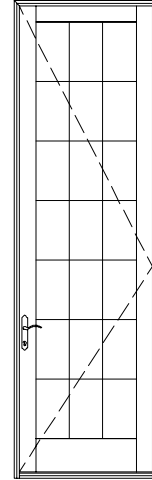

SCHED-30100

UNIT
RSO
FRAME
GLASS

5'-0"
5'-0 3/4"
5'-0"
20"

5'-6"
5'-6 3/4"
5'-6"
23"

6'-0"
6'-0 3/4"
6'-0"
26"

9'-11 1/2"
10'-0"
9'-11 1/2"
105"

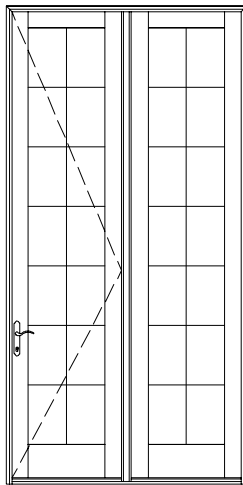

SCHED-50100

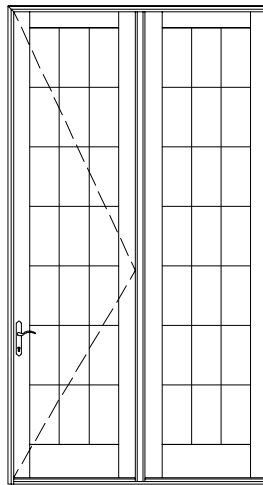

SCHED-56100

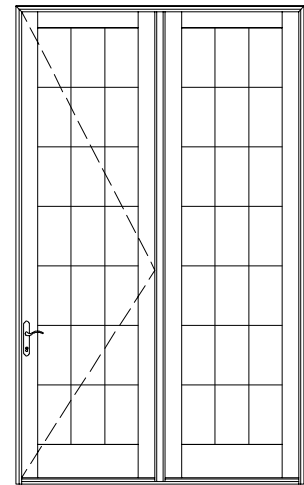

SCHED-60100

Note: Other swings may be specified.
Clad 9-0 & 10-0 high doors are not available as 3 panel and are not available as Out-Swing.

SCALE: 1/4" = 1'

9-0 SINGLE SWING IN-SWING SECTOR TOP PATIO DOORS

UNIT
RSO
FRAME
GLASS

2'-6"
2'-6 3/4"
2'-6"
20"

2'-9"
2'-9 3/4"
2'-9"
23"

3'-0"
3'-0 3/4"
3'-0"
26"

LEG
8'-0 1/2"
MAX DROP 11"

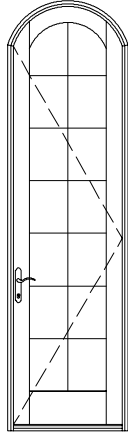

SCHD-2690 SEG TOP

LEG
8'-0 1/2"
MAX DROP 11"

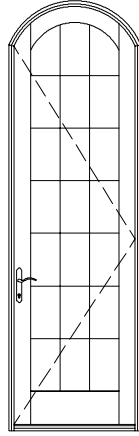

SCHD-2990 SEG TOP

LEG
8'-0 1/2"
MAX DROP 11"

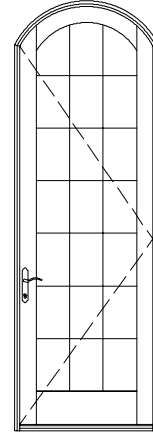

SCHD-3090 SEG TOP

8'-11 1/2"
9'-0"
8'-11 1/2"
93"

UNIT
RSO
FRAME
GLASS

5'-0"
5'-0 3/4"
5'-0"
20"

5'-6"
5'-6 3/4"
5'-6"
23"

6'-0"
6'-0 3/4"
6'-0"
26"

LEG
8'-1 1/2"
MAX DROP 10"

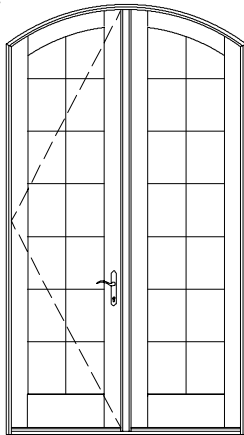

SCHD-5090 SEG TOP

LEG
8'-1 1/2"
MAX DROP 10"

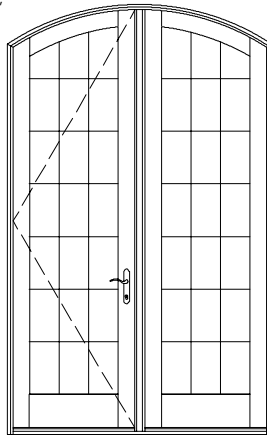

SCHD-5690 SEG TOP

LEG
8'-1 1/2"
MAX DROP 10"

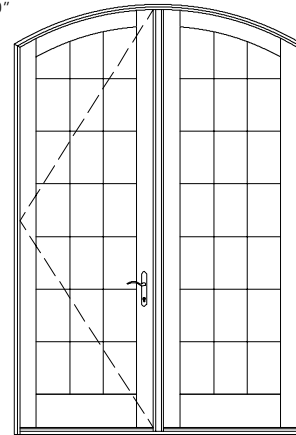

SCHD-6090 SEG TOP

8'-11 1/2"
9'-0"
8'-11 1/2"
93"

Note: Other swings may be specified.
Clad 9-0 & 10-0 high doors are not available as 3 panel and are not available as Out-Swing.
Elevations show maximum drop.

SCALE: 1/4" = 1'

10-0 SINGLE SWING IN-SWING SECTOR TOP PATIO DOORS

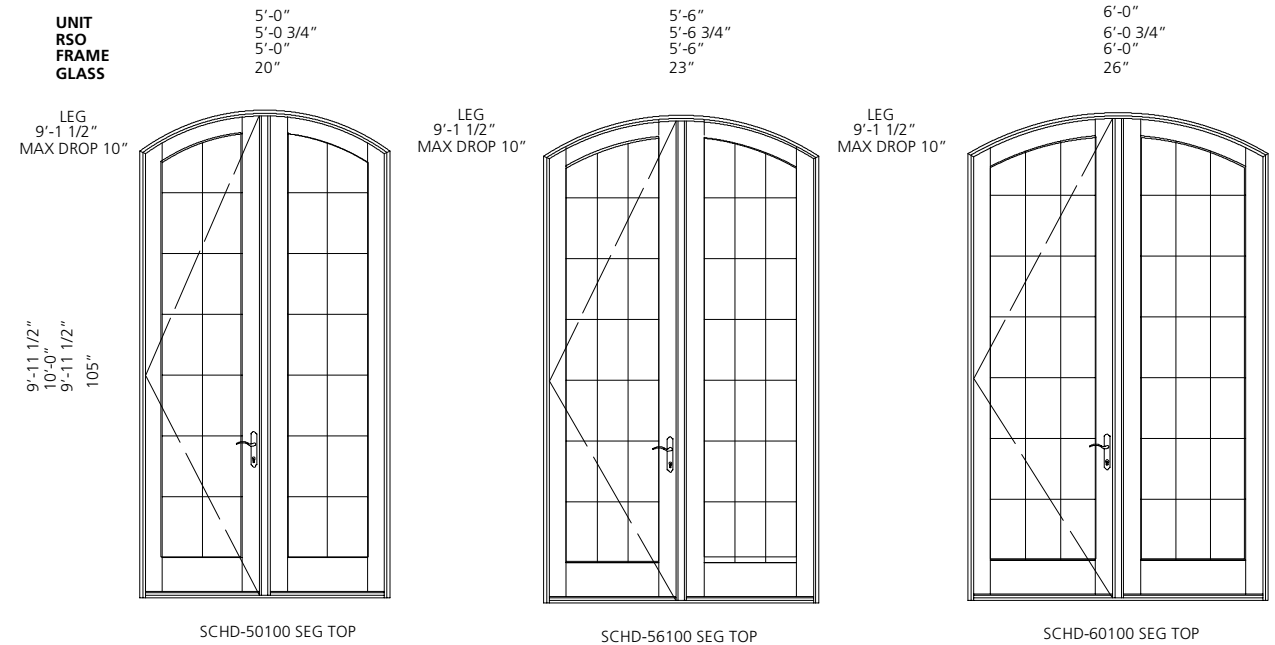
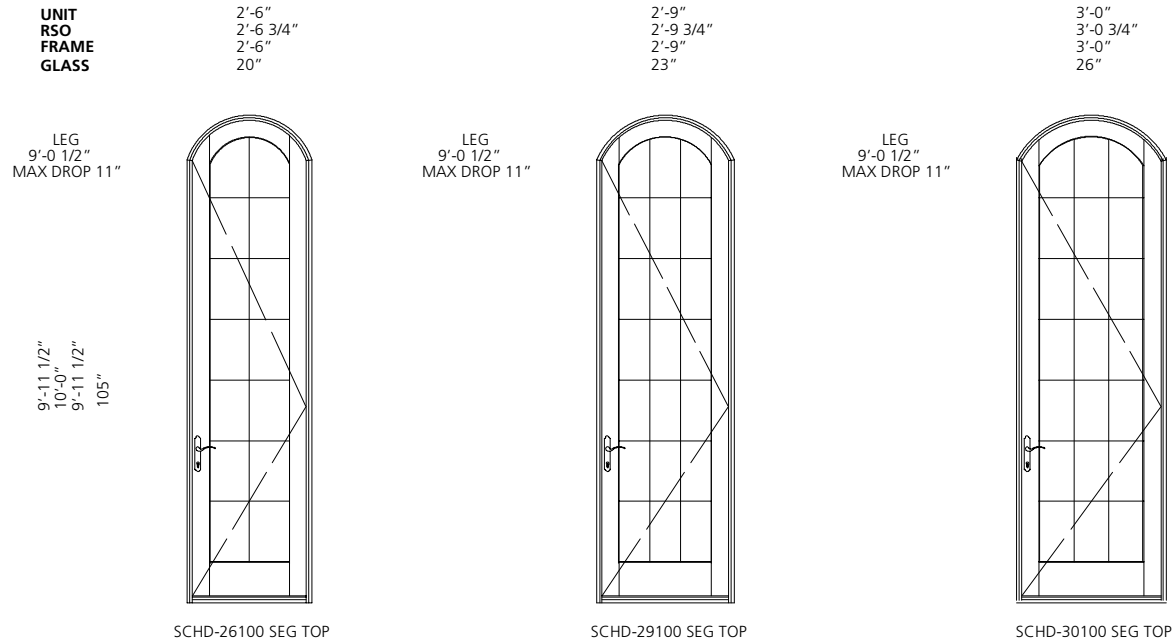

Note: Other swings may be specified.
Clad 9-0 & 10-0 high doors are not available as 3 panel and are not available as Out-Swing.
Elevations show maximum drop.

SCALE: 1/4" = 1'

9-0 & 10-0 FRENCH IN-SWING PATIO DOORS

UNIT
RSO
FRAME
GLASS

5'-0"
5'-0 3/4"
5'-0"
20"

5'-6"
5'-6 3/4"
5'-6"
23"

6'-0"
6'-0 3/4"
6'-0"
26"

8'-11 1/2"
9'-0"
8'-11 1/2"
93"

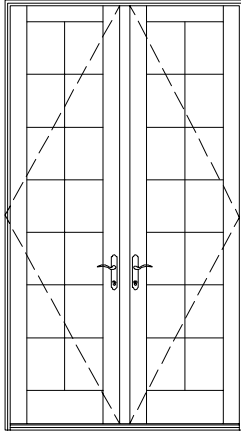

SCHD-5090F

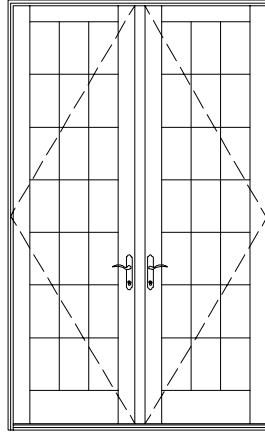

SCHD-5690F

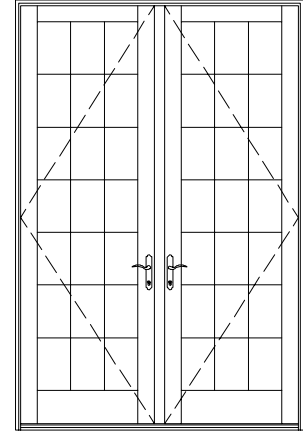

SCHD-6090F

UNIT
RSO
FRAME
GLASS

5'-0"
5'-0 3/4"
5'-0"
20"

5'-6"
5'-6 3/4"
5'-6"
23"

6'-0"
6'-0 3/4"
6'-0"
26"

9'-11 1/2"
10'-0"
9'-11 1/2"
105"

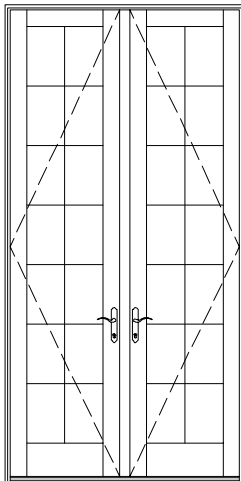

SCHD-50100F

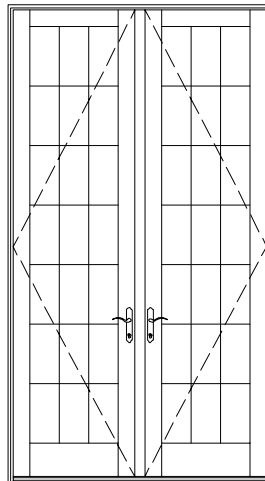

SCHD-56100F

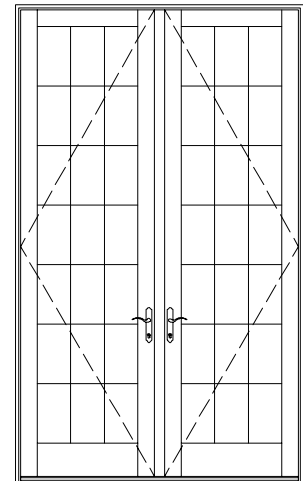

SCHD-60100F

Note: Other swings may be specified.
Clad 9-0 & 10-0 high doors are not available as 3 panel and are not available as Out-Swing.
Elevations show maximum drop.

SCALE: 1/4" = 1'

9-0 & 10-0 FRENCH IN-SWING SECTOR TOP PATIO DOORS

UNIT 5'-0"
RSO 5'-0 3/4"
FRAME 5'-0"
GLASS 20"

LEG 8'-1 1/2"
MAX DROP 10"

8'-11 1/2"
9'-0"
8'-11 1/2"
93"

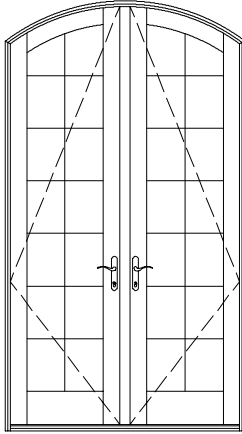

SCHD-5090F SEG TOP

5'-6"
5'-6 3/4"
5'-6"
23"

LEG 8'-1 1/2"
MAX DROP 10"

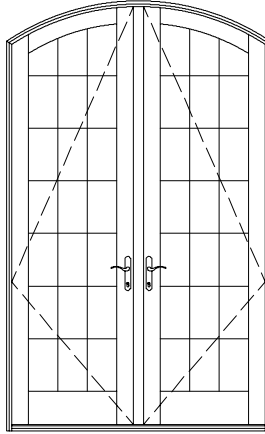

SCHD-5690F SEG TOP

6'-0"
6'-0 3/4"
6'-0"
26"

LEG 8'-1 1/2"
MAX DROP 10"

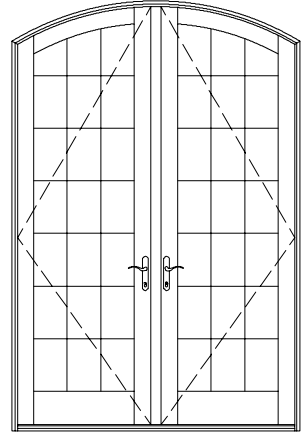

SCHD-6090F SEG TOP

UNIT 5'-0"
RSO 5'-0 3/4"
FRAME 5'-0"
GLASS 20"

LEG 9'-1 1/2"
MAX DROP 10"

9'-11 1/2"
10'-0"
9'-11 1/2"
105"

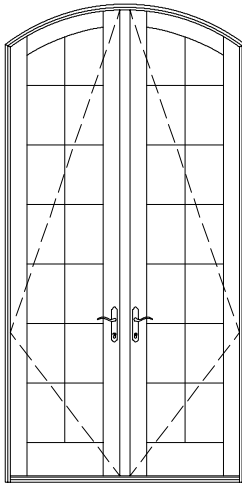

SCHD-50100F SEG TOP

5'-6"
5'-6 3/4"
5'-6"
23"

LEG 9'-1 1/2"
MAX DROP 10"

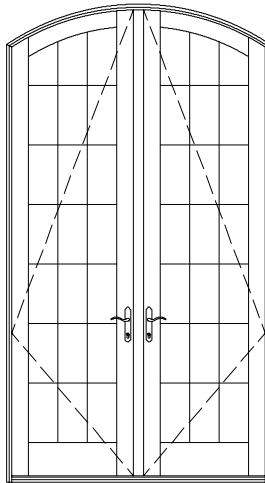

SCHD-56100F SEG TOP

6'-0"
6'-0 3/4"
6'-0"
26"

LEG 9'-1 1/2"
MAX DROP 10"

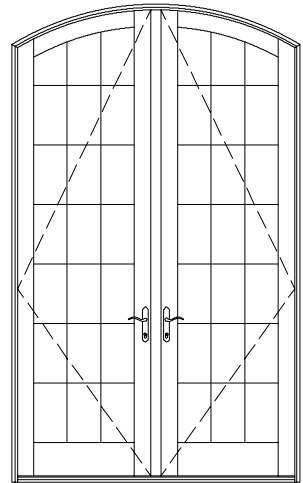

SCHD-60100F SEG TOP

Note: Other swings may be specified.
Clad 9-0 & 10-0 high doors are not available as 3 panel and are not available as Out-Swing.
Elevations show maximum drop.

SCALE: 1/4" = 1'

SWING DOOR TRANSOM ALIGNMENT GUIDE

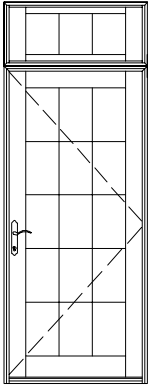

ONE PANEL TRANSOM

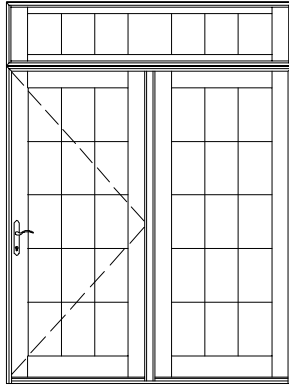

ONE PANEL TRANSOM

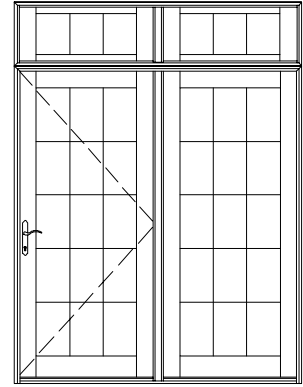

TWO PANEL TRANSOM

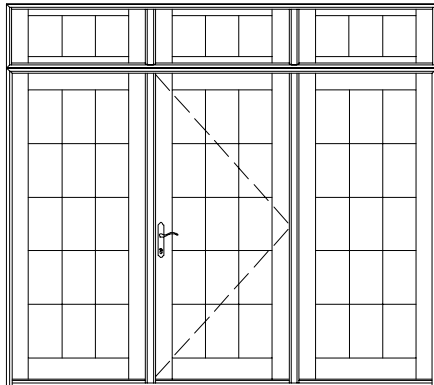



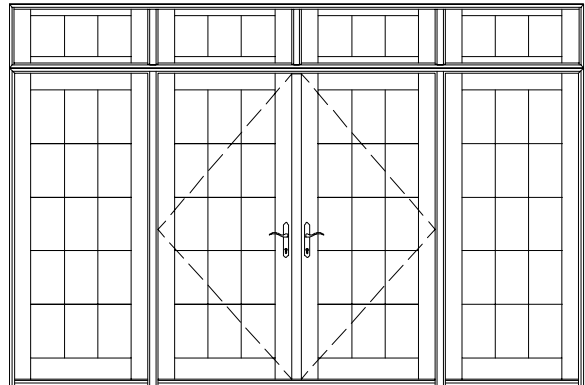









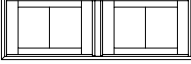

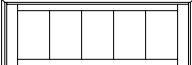
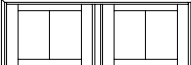
THREE PANEL TRANSOM

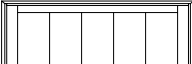
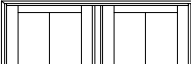
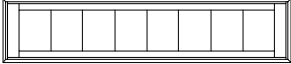
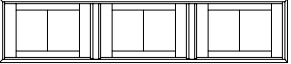

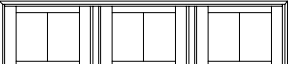
FOUR PANEL TRANSOM

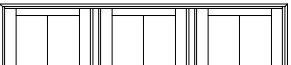
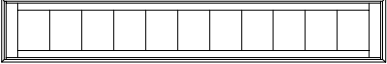
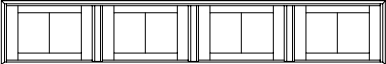
SCALE: 1/4" = 1'

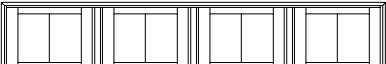
SWING DOOR TRANSOMS

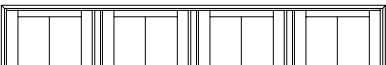
UNIT	2'-0"	4'-0"	4'-0"
RO	2'-0 3/4"	4'-0 3/4"	4'-0 3/4"
FRAME	2'-0"	4'-0"	4'-0"
GLASS	16 3/4"	40 3/4"	16 3/4"
1'-4" 1'-4 1/2" 1'-4" 11 1/16"			
	SCHED-2014T-1	SCHED-4014T-1	SCHED-4014T-2
1'-6" 1'-6 1/2" 1'-6" 13 1/16"			
	SCHED-2016T-1	SCHED-4016T-1	SCHED-4016T-2
2'-0" 2'-0 1/2" 2'-0" 19 1/16"			
	SCHED-2020T-1	SCHED-4020T-1	SCHED-4020T-2
UNIT	6'-0"	6'-0"	
RO	6'-0 3/4"	6'-0 3/4"	
FRAME	6'-0"	6'-0"	
GLASS	62"	16 3/4"	
1'-4" 1'-4 1/2" 1'-4" 11 1/16"			
	SCHED-6014T-1	SCHED-6014T-3	
1'-6" 1'-6 1/2" 1'-6" 13 1/16"			
	SCHED-6016T-1	SCHED-6016T-3	
2'-0" 2'-0 1/2" 2'-0" 19 1/16"			
	SCHED-6020T-1	SCHED-6020T-3	
UNIT	8'-0"	8'-0"	
RO	8'-0 3/4"	8'-0 3/4"	
FRAME	8'-0"	8'-0"	
GLASS	86"	16 3/4"	
1'-4" 1'-4 1/2" 1'-4" 11 1/16"			
	SCHED-8014T-1	SCHED-8014T-4	
1'-6" 1'-6 1/2" 1'-6" 13 1/16"			
	SCHED-8016T-1	SCHED-8016T-4	
2'-0" 2'-0 1/2" 2'-0" 19 1/16"			
	SCHED-8020T-1	SCHED-8020T-4	

Note: Location of sash within the Transom frame matches Inswing door panels only, see 13-92 and 13-93 for transom detail. Construction of the unit does not allow sash to be repositioned to match Out-Swing panels.

SCALE: 1/4" = 1'

SWING DOOR TRANSOMS

UNIT
RO
FRAME
GLASS

2'-6"
2'-6 3/4"
2'-6"
20"

5'-0"
5'-0 3/4"
5'-0"
50"

1'-4"
1'-4 1/2"
1'-4"
11 1/16"

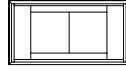

SCHD-2614T-1

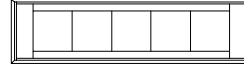

SCHD-5014T-1

1'-6"
1'-6 1/2"
1'-6"
13 1/16"

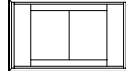

SCHD-2616T-1



SCHD-5016T-1

2'-0"
2'-0 1/2"
2'-0"
19 1/16"

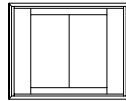

SCHD-2620T-1

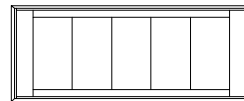

SCHD-5020T-1

UNIT
RO
FRAME
GLASS

7'-6"
7'-6 3/4"
7'-6"
80"

5'-0"
5'-0 3/4"
5'-0"
20"

1'-4"
1'-4 1/2"
1'-4"
11 1/16"

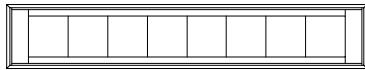

SCHD-7614T-1

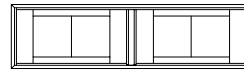

SCHD-5014T-2

1'-6"
1'-6 1/2"
1'-6"
13 1/16"

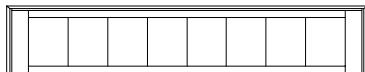

SCHD-7616T-1

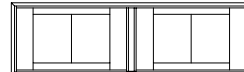

SCHD-5016T-2

2'-0"
2'-0 1/2"
2'-0"
19 1/16"

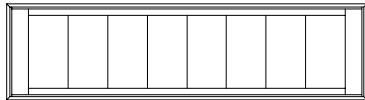

SCHD-7620T-1

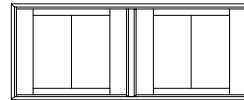

SCHD-5020T-2

UNIT
RO
FRAME
GLASS

7'-6"
7'-6 3/4"
7'-6"
20"

10'-0"
10'-0 3/4"
10'-0"
20"

1'-4"
1'-4 1/2"
1'-4"
11 1/16"

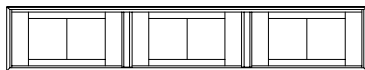

SCHD-7614T-3

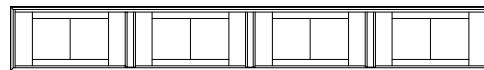

SCHD-10014T-4

1'-6"
1'-6 1/2"
1'-6"
13 1/16"



SCHD-7616T-3

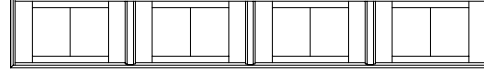

SCHD-10016T-4

2'-0"
2'-0 1/2"
2'-0"
19 1/16"

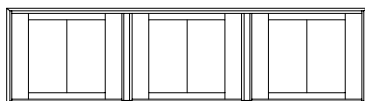

SCHD-7620T-3

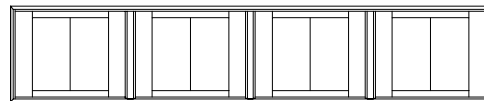

SCHD-10020T-4

Note: Location of sash within the Transom frame matches Inswing door panels only, see 13-92 and 13-93 for transom detail. Construction of the unit does not allow sash to be repositioned to match Out-Swing panels.

SCALE: 1/4" = 1'

SWING DOOR TRANSOMS

UNIT
RO
FRAME
GLASS

2'-9"
2'-9 3/4"
2'-9"
23"

5'-6"
5'-6 3/4"
5'-6"
23"

1'-4"
1'-4 1/2"
1'-4"
11 1/16"



SCHED-2914T-1

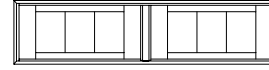

SCHED-5614T-2

1'-6"
1'-6 1/2"
1'-6"
13 1/16"

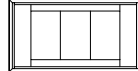

SCHED-2916T-1

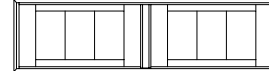

SCHED-5616T-2

2'-0"
2'-0 1/2"
2'-0"
19 1/16"

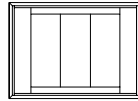

SCHED-2920T-1

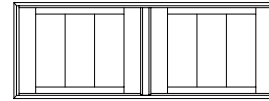

SCHED-5620T-2

UNIT
RO
FRAME
GLASS

5'-6"
5'-6 3/4"
5'-6"
56"

8'-3"
8'-3 3/4"
8'-3"
23"

1'-4"
1'-4 1/2"
1'-4"
11 1/16"

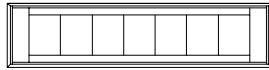

SCHED-5614T-1

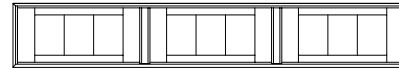

SCHED-8314T-3

1'-6"
1'-6 1/2"
1'-6"
13 1/16"



SCHED-5616T-1

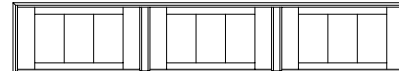

SCHED-8316T-3

2'-0"
2'-0 1/2"
2'-0"
19 1/16"

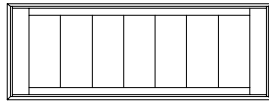

SCHED-5620T-1

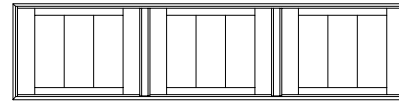

SCHED-8320T-3

UNIT
RO
FRAME
GLASS

11'-0"
11'-0 3/4"
11'-0"
23"

1'-4"
1'-4 1/2"
1'-4"
11 1/16"

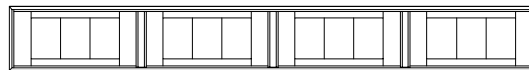

SCHED-11014T-4

1'-6"
1'-6 1/2"
1'-6"
13 1/16"

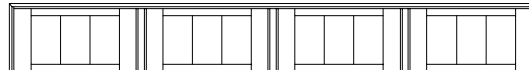

SCHED-11016T-4

2'-0"
2'-0 1/2"
2'-0"
19 1/16"

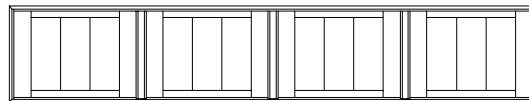

SCHED-11020T-4

Note: Location of sash within the Transom frame matches Inswing door panels only, see 13-92 and 13-93 for transom detail. Construction of the unit does not allow sash to be repositioned to match Out-Swing panels.

SCALE: 1/4" = 1'

SWING DOOR TRANSOMS

UNIT
RO
FRAME
GLASS

3'-0"
3'-0 3/4"
3'-0"
26"

6'-0"
6'-0 3/4"
6'-0"
26"

1'-4"
1'-4 1/2"
1'-4"
11 1/16"



SCHD-3014T-1

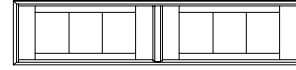

SCHD-6014T-2

1'-6"
1'-6 1/2"
1'-6"
13 1/16"



SCHD-3016T-1

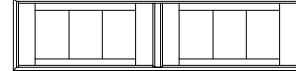

SCHD-6016T-2

2'-0"
2'-0 1/2"
2'-0"
19 1/16"

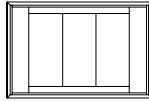

SCHD-3020T-1

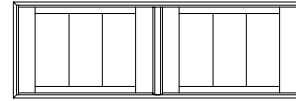

SCHD-6020T-2

UNIT
RO
FRAME
GLASS

6'-0"
6'-0 3/4"
6'-0"
62"

9'-0"
9'-0 3/4"
9'-0"
26"

1'-4"
1'-4 1/2"
1'-4"
11 1/16"

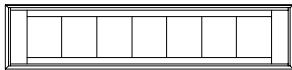

SCHD-6014T-1



SCHD-9014T-3

1'-6"
1'-6 1/2"
1'-6"
13 1/16"



SCHD-6016T-1

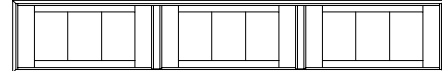

SCHD-9016T-3

2'-0"
2'-0 1/2"
2'-0"
19 1/16"

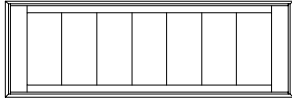

SCHD-6020T-1

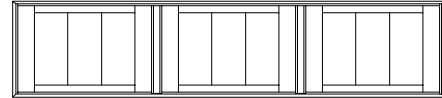

SCHD-9020T-3

UNIT
RO
FRAME
GLASS

12'-0"
12'-0 3/4"
12'-0"
26"

1'-4"
1'-4 1/2"
1'-4"
11 1/16"

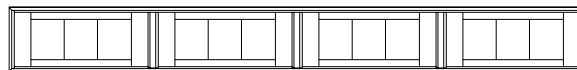

SCHD-12014T-4

1'-6"
1'-6 1/2"
1'-6"
13 1/16"

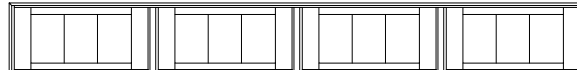

SCHD-12016T-4

2'-0"
2'-0 1/2"
2'-0"
19 1/16"

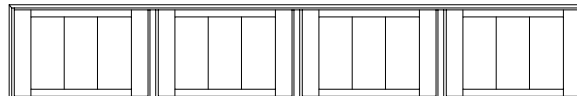

SCHD-12020T-4

Note: Location of sash within the Transom frame matches Inswing door panels only, see 13-92 and 13-93 for transom detail. Construction of the unit does not allow sash to be repositioned to match Out-Swing panels.

SCALE: 1/4" = 1'

PANEL GLAZING OPTIONS

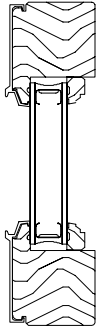

3/4" INSULATED

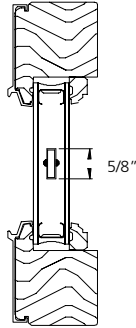

3/4" INSULATED WITH 5/8" AIRSPACE GRILLE

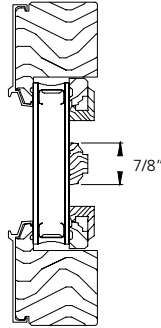

3/4" INSULATED WITH 7/8" FULL SURROUND WOOD GRILLE

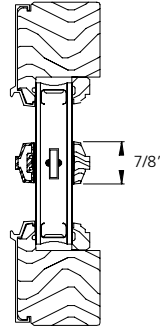

3/4" INSULATED WITH 7/8" SDL WITH SHADOW BAR

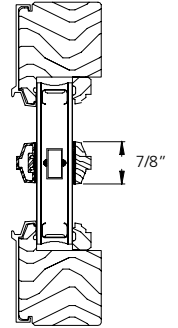

3/4" INSULATED WITH 7/8" SDL WITH SILVER SPACER

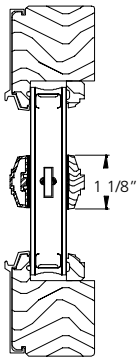

3/4" INSULATED WITH 1 1/8" SDL WITH SHADOW BAR

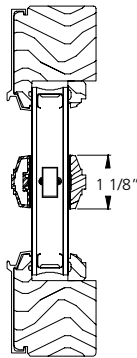

3/4" INSULATED WITH 1 1/8" SDL WITH SILVER SPACER

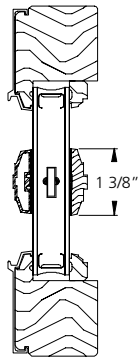

3/4" INSULATED WITH 1 3/8" SDL WITH SHADOW BAR

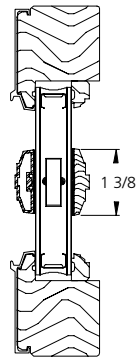

3/4" INSULATED WITH 1 3/8" SDL WITH SILVER SPACER

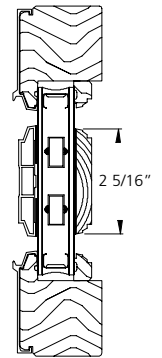

3/4" INSULATED WITH 2 5/16" SIMULATED CHECK RAIL WITH SILVER SPACER BARS (SHADOW BAR ALSO AVAILABLE)

NOTE: SDL not available on textured glass.

SCALE: 3" = 1'

**TRIM OPTIONS
IN-SWING PATIO DOORS**

EXTERIOR TRIM

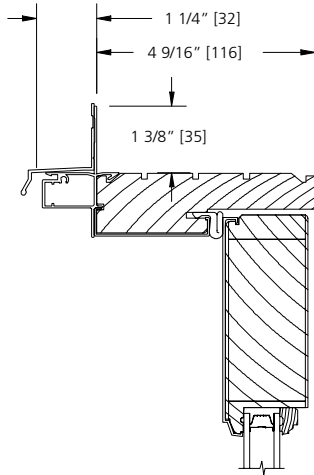

STANDARD

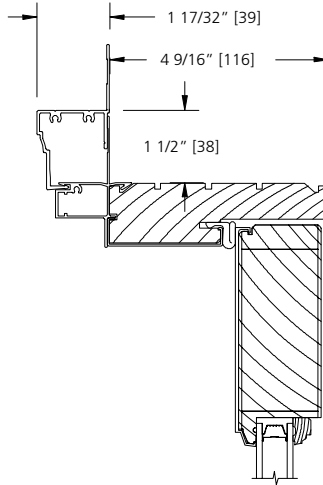

BRICKMOULD

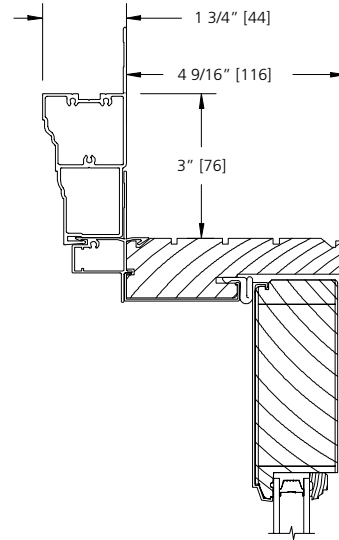

ADAMS CASING

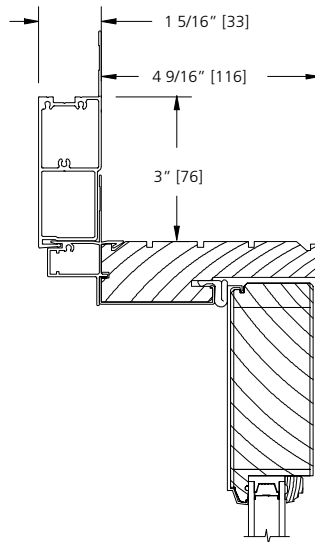

3 1/2\"/>

SCALE: 3" = 1'

**TRIM OPTIONS
OUT-SWING PATIO DOORS**

EXTERIOR TRIM

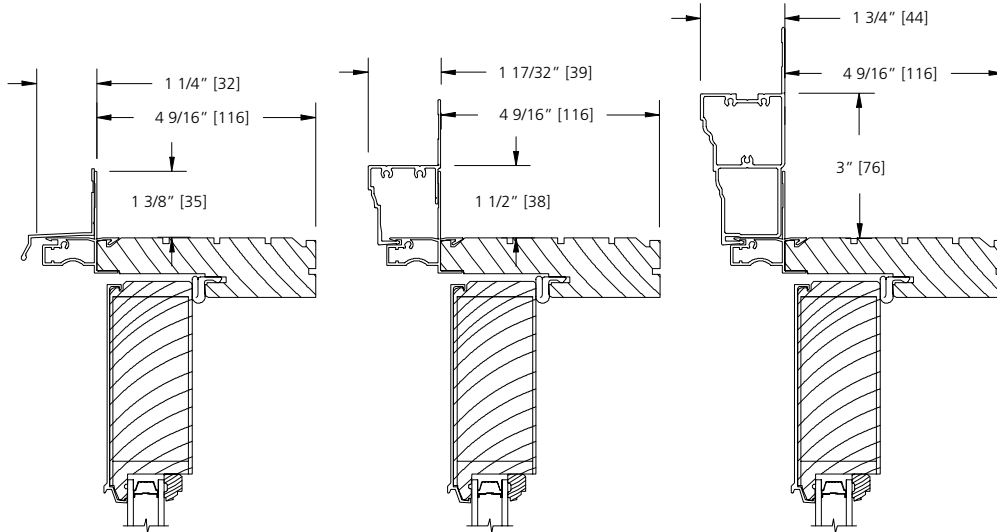

STANDARD

BRICKMOULD

ADAMS CASING

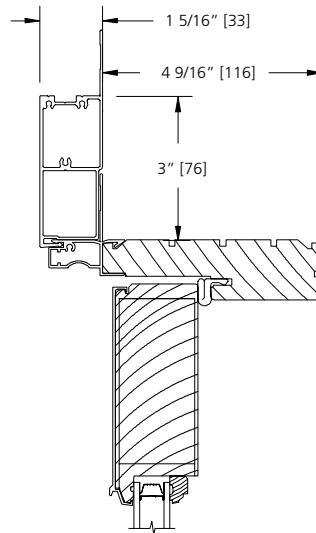

3 1/2" FLAT CASING

SCALE: 3" = 1'

LITE CUT INFORMATION

Clad In-Swing and Out-Swing patio doors are available in 7/8", 1-1/8" and 1-3/8" widths for SDL (Simulated Divided Lites), 5/8", 23/32" and 1" GBG (Grilles between the Glass) and 7/8" removable grilles. Standard lite cuts are rectangular.

LITE CUT OPTIONS

Special lite cut patterns can include a wide variety of straight line and radius patterns. The illustrations shown here represent just a few of the possibilities. Rectangular, horizontal, vertical and Prairie lite patterns are available in all standard size clad swinging patio doors. Uneven, diamond, radius and Gothic lite cuts are available, subject to approval. Approvals are based on the ability to fulfill the design requirement while maintaining the construction integrity of the finished product.

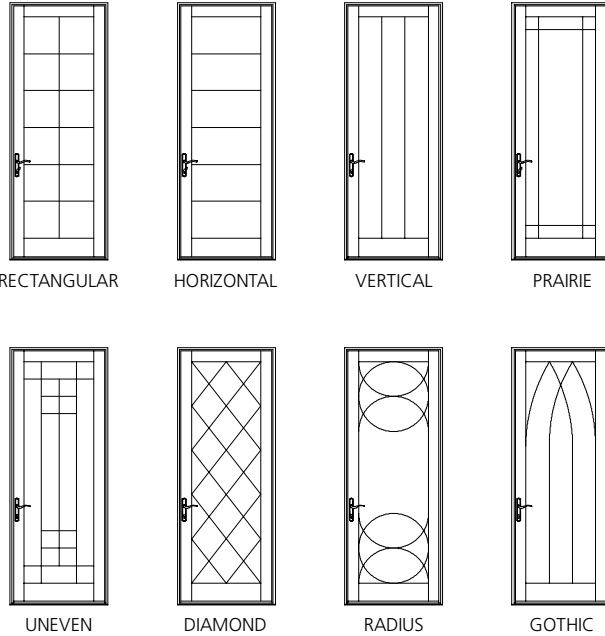

BAR ALIGNMENT

Alignment of divided lite muntin bars from one product to the next is often required by fine architectural design. Wood grilles, GBG's, and Simulated Divided Lites may be specified with muntin bars aligned.



GRILLES & SDL LITE PATTERNS

CLAD SWING DOORS - Standard Lite Patterns

Applies to all Wood Grilles, Airspace Grilles, and SDL (Simulated Divided Lite)

SINGLE SWING DOORS

6-8 HEIGHT		6-11 HEIGHT		7-3 HEIGHT		8-0 HEIGHT	
UNIT SIZE	STANDARD LITE PATTERN	UNIT SIZE	STANDARD LITE PATTERN	UNIT SIZE	STANDARD LITE PATTERN	UNIT SIZE	STANDARD LITE PATTERN
SCHD 2668	2W x 5H	SCHD 26611	2W x 5H	SCHD 2673	2W x 5H	SCHD 2680	2W x 6H
SCHD 5068	2W x 5H	SCHD 50611	2W x 5H	SCHD 5073	2W x 5H	SCHD 5080	2W x 6H
SCHD 7668	2W x 5H	SCHD 76611	2W x 5H	SCHD 7673	2W x 5H	SCHD 7680	2W x 6H
SCHD 2968	3W x 5H	SCHD 29611	3W x 5H	SCHD 2973	3W x 5H	SCHD 2980	3W x 6H
SCHD 5668	3W x 5H	SCHD 56611	3W x 5H	SCHD 5673	3W x 5H	SCHD 5680	3W x 6H
SCHD 8368	3W x 5H	SCHD 83611	3W x 5H	SCHD 8373	3W x 5H	SCHD 8380	3W x 6H
SCHD 3068	3W x 5H	SCHD 30611	3W x 5H	SCHD 3073	3W x 5H	SCHD 3080	3W x 6H
SCHD 6068	3W x 5H	SCHD 60611	3W x 5H	SCHD 6073	3W x 5H	SCHD 6080	3W x 6H
SCHD 9068	3W x 5H	SCHD 90611	3W x 5H	SCHD 9073	3W x 5H	SCHD 9080	3W x 6H
SCHD 3068 COM	3W x 5H	SCHD 30611 COM	3W x 5H	SCHD 3073 COM	3W x 5H	SCHD 3080 COM	3W x 6H
SCHD 6068 COM	3W x 5H	SCHD 60611 COM	3W x 5H	SCHD 6073 COM	3W x 5H	SCHD 6080 COM	3W x 6H
SCHD 9068 COM	3W x 5H	SCHD 90611 COM	3W x 5H	SCHD 9073 COM	3W x 5H	SCHD 9080 COM	3W x 6H

FRENCH SWING DOORS

6-8 HEIGHT		6-11 HEIGHT		7-3 HEIGHT		8-0 HEIGHT	
UNIT SIZE	STANDARD LITE PATTERN	UNIT SIZE	STANDARD LITE PATTERN	UNIT SIZE	STANDARD LITE PATTERN	UNIT SIZE	STANDARD LITE PATTERN
SCHD 4068F	2W x 5H	SCHD 40611F	2W x 5H	SCHD 4073F	2W x 5H	SCHD 4080F	2W x 6H
SCHD 5068F	2W x 5H	SCHD 50611F	2W x 5H	SCHD 5073F	2W x 5H	SCHD 5080F	2W x 6H
SCHD 5668F	3W x 5H	SCHD 56611F	3W x 5H	SCHD 5673F	3W x 5H	SCHD 5680F	3W x 6H
SCHD 6068F	3W x 5H	SCHD 60611F	3W x 5H	SCHD 6073F	3W x 5H	SCHD 6080F	3W x 6H

PINE BOTTOM PANEL SWING DOORS

6-8 HEIGHT		6-11 HEIGHT		7-3 HEIGHT		8-0 HEIGHT	
UNIT SIZE	STANDARD LITE PATTERN	UNIT SIZE	STANDARD LITE PATTERN	UNIT SIZE	STANDARD LITE PATTERN	UNIT SIZE	STANDARD LITE PATTERN
SCHD 2668	2W x 3H	SCHD 26611	2W x 3H	SCHD 2673	2W x 3H	SCHD 2680	2W x 4H
SCHD 5068	2W x 3H	SCHD 50611	2W x 3H	SCHD 5073	2W x 3H	SCHD 5080	2W x 4H
SCHD 7668	2W x 3H	SCHD 76611	2W x 3H	SCHD 7673	2W x 3H	SCHD 7680	2W x 4H
SCHD 2968	3W x 3H	SCHD 29611	3W x 3H	SCHD 2973	3W x 3H	SCHD 2980	3W x 4H
SCHD 5668	3W x 3H	SCHD 56611	3W x 3H	SCHD 5673	3W x 3H	SCHD 5680	3W x 4H
SCHD 8368	3W x 3H	SCHD 83611	3W x 3H	SCHD 8373	3W x 3H	SCHD 8380	3W x 4H
SCHD 3068	3W x 3H	SCHD 30611	3W x 3H	SCHD 3073	3W x 3H	SCHD 3080	3W x 4H
SCHD 6068	3W x 3H	SCHD 60611	3W x 3H	SCHD 6073	3W x 3H	SCHD 6080	3W x 4H
SCHD 9068	3W x 3H	SCHD 90611	3W x 3H	SCHD 9073	3W x 3H	SCHD 9080	3W x 4H
SCHD 3068 COM	3W x 3H	SCHD 30611 COM	3W x 3H	SCHD 3073 COM	3W x 3H	SCHD 3080 COM	3W x 4H
SCHD 6068 COM	3W x 3H	SCHD 60611 COM	3W x 3H	SCHD 6073 COM	3W x 3H	SCHD 6080 COM	3W x 4H
SCHD 9068 COM	3W x 3H	SCHD 90611 COM	3W x 3H	SCHD 9073 COM	3W x 3H	SCHD 9080 COM	3W x 4H

SEGMENT HEAD SWING DOORS

6-8 HEIGHT		6-11 HEIGHT		7-3 HEIGHT		8-0 HEIGHT	
UNIT SIZE	STANDARD LITE PATTERN	UNIT SIZE	STANDARD LITE PATTERN	UNIT SIZE	STANDARD LITE PATTERN	UNIT SIZE	STANDARD LITE PATTERN
SCHD 2668	2W x 5H	SCHD 26611	2W x 5H	SCHD 2673	2W x 5H	SCHD 2680	2W x 6H
SCHD 5068	2W x 5H	SCHD 50611	2W x 5H	SCHD 5073	2W x 5H	SCHD 5080	2W x 6H
SCHD 2968	3W x 5H	SCHD 29611	3W x 5H	SCHD 2973	3W x 5H	SCHD 2980	3W x 6H
SCHD 5668	3W x 5H	SCHD 56611	3W x 5H	SCHD 5673	3W x 5H	SCHD 5680	3W x 6H
SCHD 3068	3W x 5H	SCHD 30611	3W x 5H	SCHD 3073	3W x 5H	SCHD 3080	3W x 6H
SCHD 6068	3W x 5H	SCHD 60611	3W x 5H	SCHD 6073	3W x 5H	SCHD 6080	3W x 6H
SCHD 3068 COM	3W x 5H	SCHD 30611 COM	3W x 5H	SCHD 3073 COM	3W x 5H	SCHD 3080 COM	3W x 6H
SCHD 6068 COM	3W x 5H	SCHD 60611 COM	3W x 5H	SCHD 6073 COM	3W x 5H	SCHD 6080 COM	3W x 6H
SCHD 4068F	2W x 5H	SCHD 40611F	2W x 5H	SCHD 4073F	2W x 5H	SCHD 4080F	2W x 6H
SCHD 5068F	2W x 5H	SCHD 50611F	2W x 5H	SCHD 5073F	2W x 5H	SCHD 5080F	2W x 6H
SCHD 5668F	3W x 5H	SCHD 56611F	3W x 5H	SCHD 5673F	3W x 5H	SCHD 5680F	3W x 6H
SCHD 6068F	3W x 5H	SCHD 60611F	3W x 5H	SCHD 6073F	3W x 5H	SCHD 6080F	3W x 6H
SCHD 6068F COM	3W x 5H	SCHD 60611F COM	3W x 5H	SCHD 6073F COM	3W x 5H	SCHD 6080F COM	3W x 6H

CUSTOM LITE PATTERNS ARE AVAILABLE

NOTE: LISTED LITE PATTERNS ARE PER DOOR PANEL

**CLEAR OPENING LAYOUT
IN-SWING PATIO DOORS**

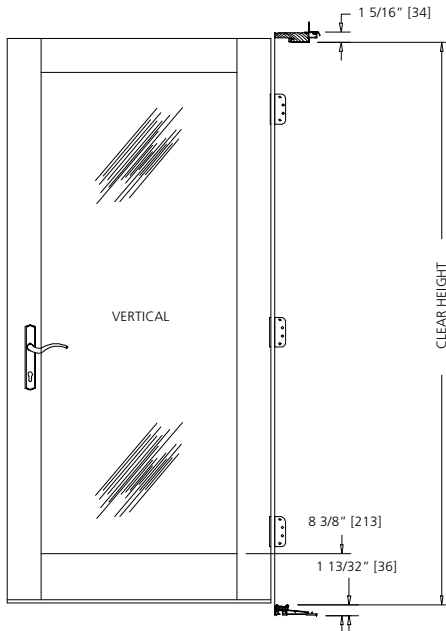

HORIZONTAL
Swinging door hinged off jamb

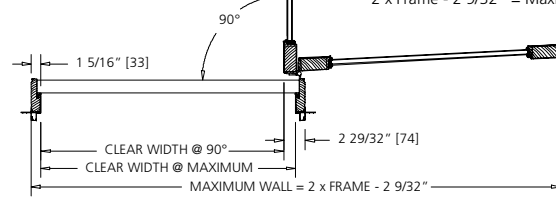

CLEAR OPENING FORMULA:
HORIZONTAL
Frame - 4 5/16" = Clear Opening @ 90°
Frame - 2 11/16" = Clear Opening @ Maximum
2 x Frame - 2 9/32" = Maximum Wall

HORIZONTAL
Swinging door hinged off fixed mullion

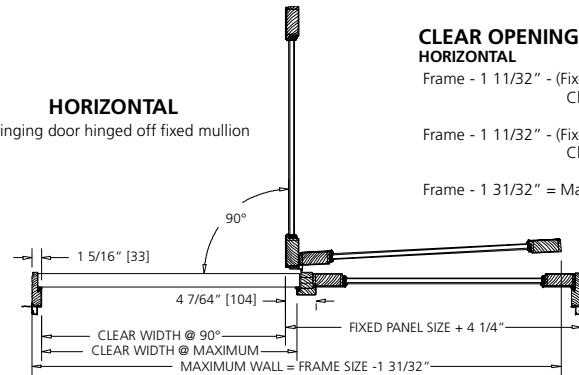

CLEAR OPENING FORMULA:
HORIZONTAL
Frame - 1 11/32" - (Fixed panel size + 4 1/4") =
Clear opening @ 90°
Frame - 1 11/32" - (Fixed panel size + 2 7/16") =
Clear opening @ maximum
Frame - 1 31/32" = Maximum wall

VERTICAL
Standard sill
Frame - 2 23/32" = Clear height
Handicap sill
Frame - 1 27/32" = Clear height

Daylight opening height at bottom
rail to handicap sill is 12" with
10-1/4" bottom rail, and 8-3/8"
with standard bottom rail.

HORIZONTAL
Swinging door hinged off jamb

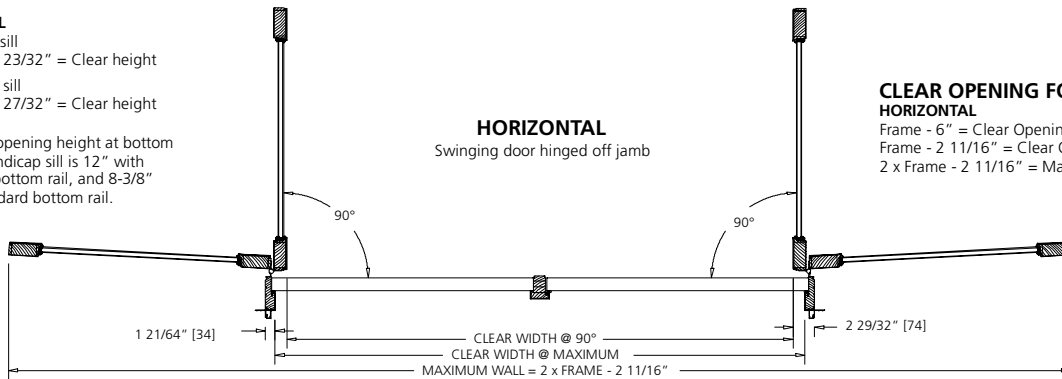

CLEAR OPENING FORMULA:
HORIZONTAL
Frame - 6" = Clear Opening @ 90°
Frame - 2 11/16" = Clear Opening @ Maximum
2 x Frame - 2 11/16" = Maximum Wall

HORIZONTAL
Swinging door hinged off fixed mullion

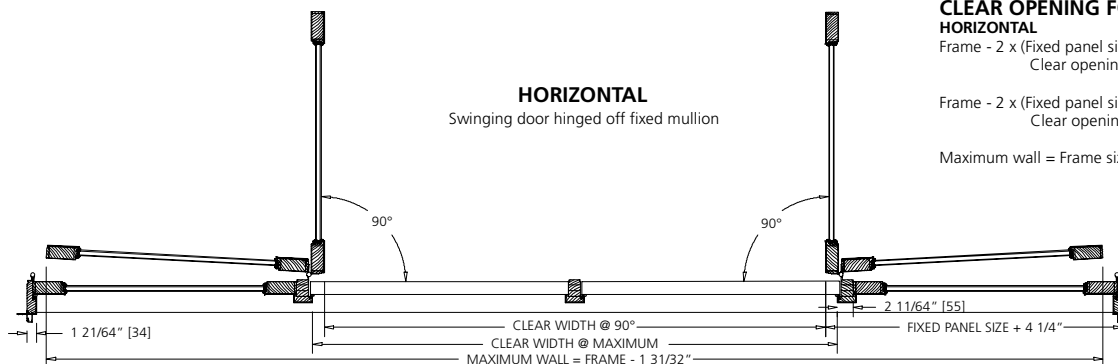

CLEAR OPENING FORMULA:
HORIZONTAL
Frame - 2 x (Fixed panel size + 4 1/4") =
Clear opening @ 90°
Frame - 2 x (Fixed panel size + 2 7/16") =
Clear opening @ maximum
Maximum wall = Frame size - 1 31/32"

**CLEAR OPENING LAYOUT
OUT-SWING PATIO DOORS**

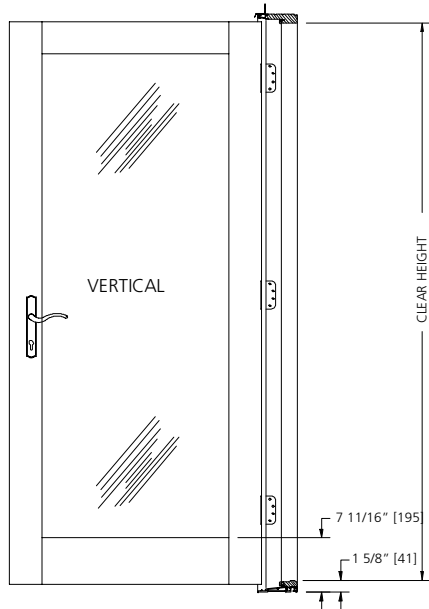

HORIZONTAL
Swinging door hinged off jamb

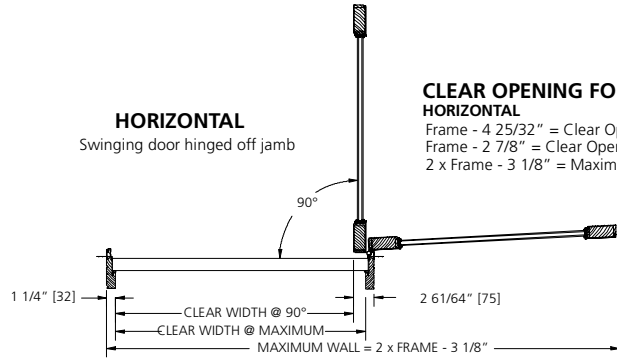

**CLEAR OPENING FORMULA:
HORIZONTAL**

Frame - 4 25/32" = Clear Opening @ 90°
Frame - 2 7/8" = Clear Opening @ Maximum
2 x Frame - 3 1/8" = Maximum Wall

NOTE: DETAILS ARE SHOWN WITH STANDARD HINGES. OPERATION OF UNITS WITH ADJUSTABLE HINGES WILL HAVE LIMITED ROTATION.

**CLEAR OPENING FORMULA:
HORIZONTAL**

Frame - 1 7/16" - (Fixed panel size + 4 21/32") = Clear opening @ 90°

Frame - 1 7/16" - (Fixed panel size + 2 3/4") = Clear opening @ maximum

Frame - 2 5/16" = Maximum wall

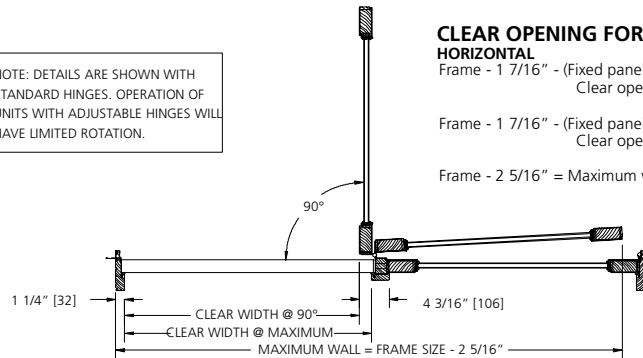

VERTICAL
Standard sill
Frame - 3 1/8" = Clear height
Handicap sill
Frame - 1 15/16" = Clear height

Daylight opening height at bottom rail to handicap sill is 11 5/16" with 10-1/4" bottom rail, and 7 11/16" with standard bottom rail.

HORIZONTAL
Swinging door hinged off jamb

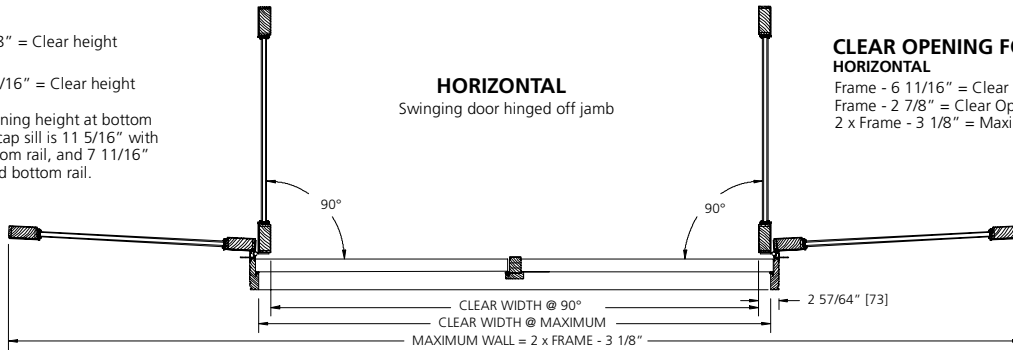

**CLEAR OPENING FORMULA:
HORIZONTAL**

Frame - 6 11/16" = Clear Opening @ 90°
Frame - 2 7/8" = Clear Opening @ Maximum
2 x Frame - 3 1/8" = Maximum Wall

HORIZONTAL
Swinging door hinged off fixed mullion

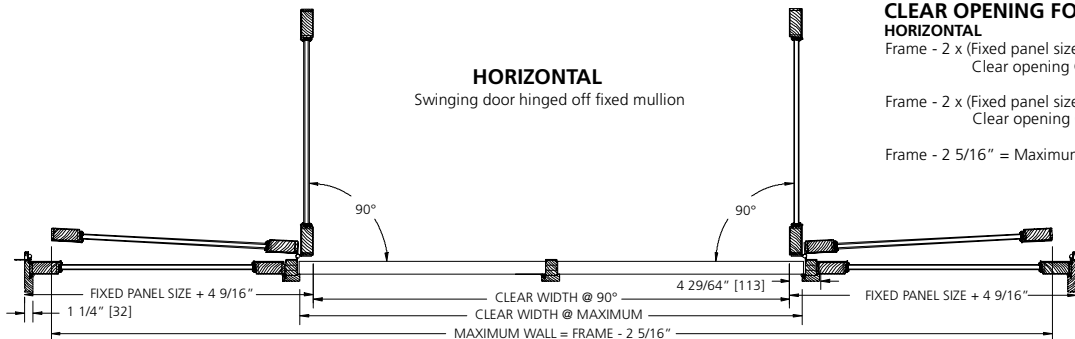

**CLEAR OPENING FORMULA:
HORIZONTAL**

Frame - 2 x (Fixed panel size + 4 9/16") = Clear opening @ 90°

Frame - 2 x (Fixed panel size + 2 3/4") = Clear opening @ maximum

Frame - 2 5/16" = Maximum Wall

CLEAR OPENING LAYOUT
SECTOR TOP IN-SWING PATIO DOORS

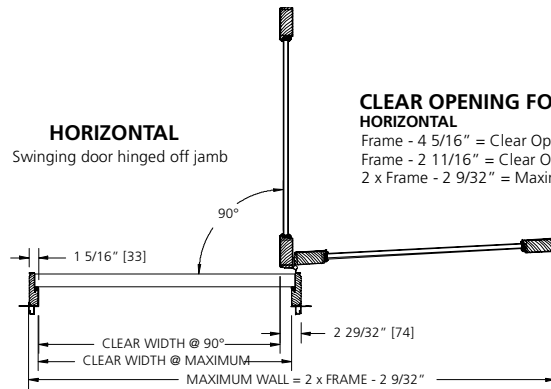
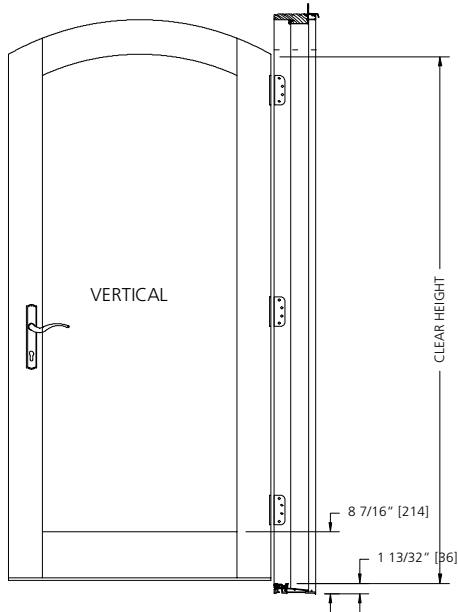

CLEAR OPENING FORMULA:
HORIZONTAL

Frame - $4 \frac{5}{16}''$ = Clear Opening @ 90°
 Frame - $2 \frac{11}{16}''$ = Clear Opening @ Maximum
 $2 \times$ Frame - $2 \frac{9}{32}''$ = Maximum Wall

VERTICAL

Radius head clear opening height varies with unit width - see table.

Daylight opening height at bottom rail to handicap sill is 12" with 10-1/4" bottom rail, and 8-3/8" with standard bottom rail.

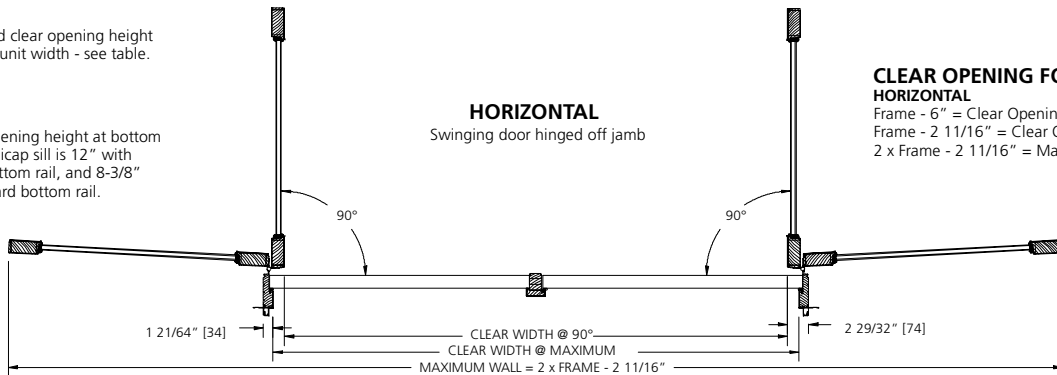

CLEAR OPENING FORMULA:
HORIZONTAL

Frame - 6" = Clear Opening @ 90°
 Frame - $2 \frac{11}{16}''$ = Clear Opening @ Maximum
 $2 \times$ Frame - $2 \frac{11}{16}''$ = Maximum Wall

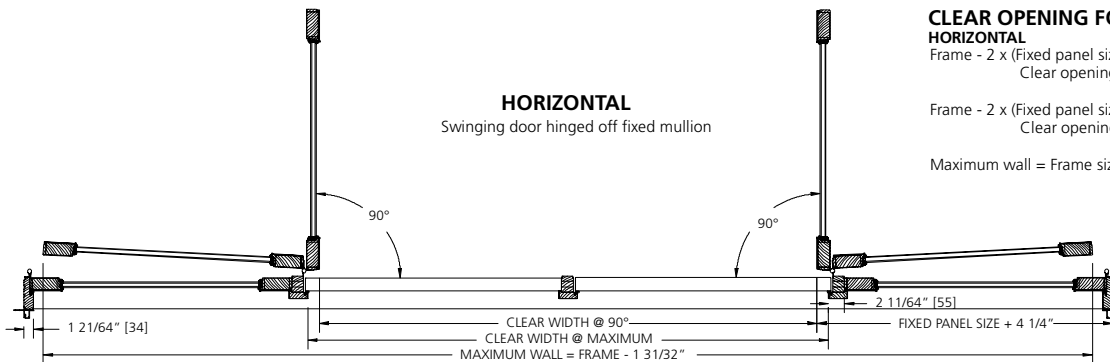

CLEAR OPENING FORMULA:
HORIZONTAL

Frame - $2 \times$ (Fixed panel size + $4 \frac{1}{4}''$) = Clear opening @ 90°
 Frame - $2 \times$ (Fixed panel size + $2 \frac{7}{16}''$) = Clear opening @ maximum
 Maximum wall = Frame size - $1 \frac{31}{32}''$

**CLEAR OPENING LAYOUT
SECTOR TOP OUT-SWING PATIO DOORS**

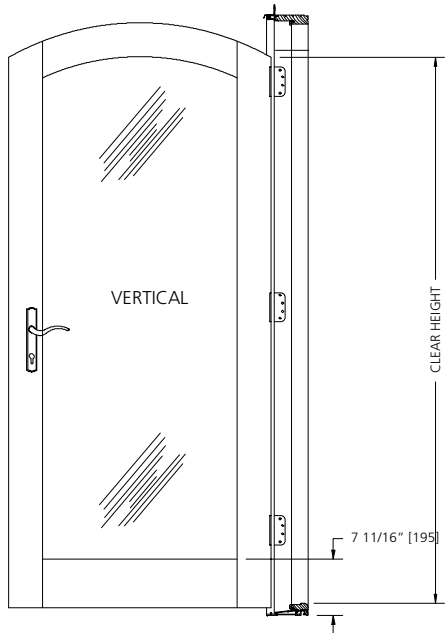

NOTE: DETAILS ARE SHOWN WITH STANDARD HINGES. OPERATION OF UNITS WITH ADJUSTABLE HINGES WILL HAVE LIMITED ROTATION.

HORIZONTAL
Swinging door hinged off jamb

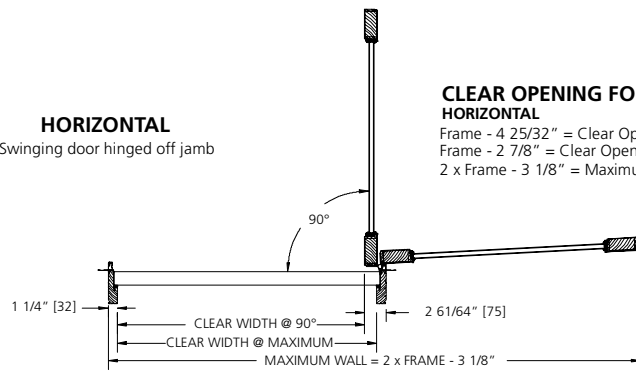

**CLEAR OPENING FORMULA:
HORIZONTAL**
Frame - 4 25/32" = Clear Opening @ 90°
Frame - 2 7/8" = Clear Opening @ Maximum
2 x Frame - 3 1/8" = Maximum Wall

VERTICAL
Radius head clear opening height varies with unit width - see table.

Daylight opening height at bottom rail to handicap sill is 11 5/16" with 10-1/4" bottom rail, and 7 11/16" with standard bottom rail.

HORIZONTAL
Swinging door hinged off jamb

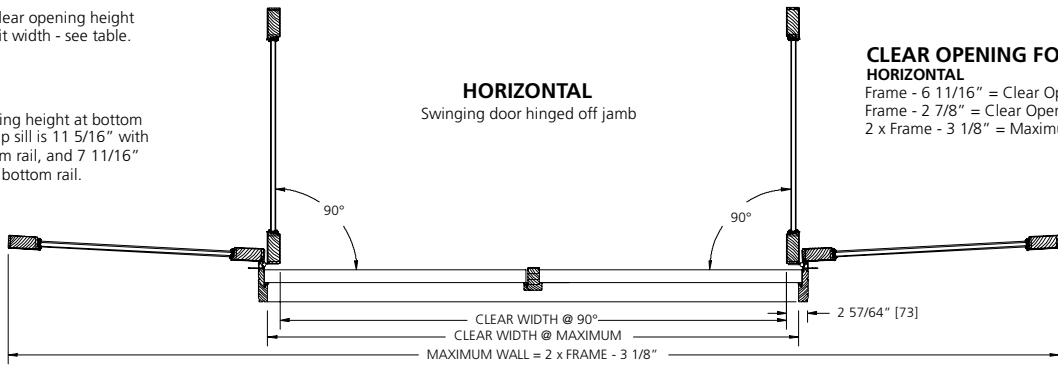

**CLEAR OPENING FORMULA:
HORIZONTAL**
Frame - 6 11/16" = Clear Opening @ 90°
Frame - 2 7/8" = Clear Opening @ Maximum
2 x Frame - 3 1/8" = Maximum Wall

HORIZONTAL
Swinging door hinged off fixed mullion

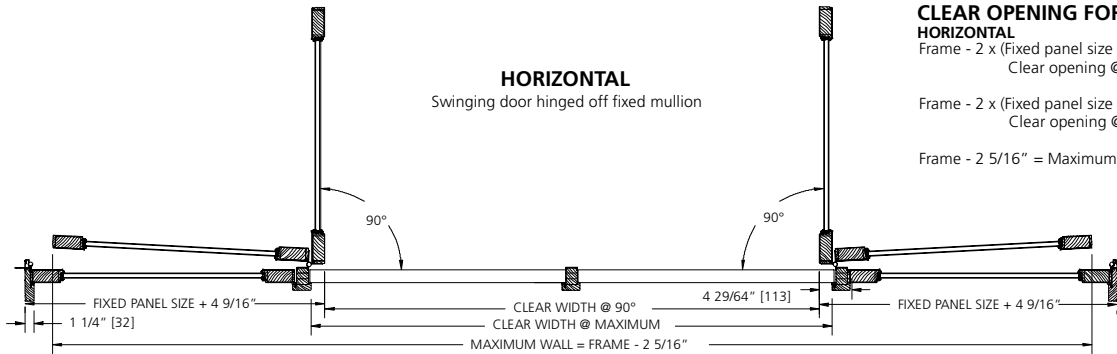

**CLEAR OPENING FORMULA:
HORIZONTAL**
Frame - 2 x (Fixed panel size + 4 9/16") = Clear opening @ 90°
Frame - 2 x (Fixed panel size + 2 3/4") = Clear opening @ maximum
Frame - 2 5/16" = Maximum Wall

CLEAR OPENING AND DAYLIGHT SPECIFICATIONS

SINGLE SWING DOORS

Unit No.	Sq. Ft. Vent & Clear Opening Per Operating Panel	Clear Opening		Sq. Ft. Daylight Opening Per Panel	Sq. Ft. Unit
		Width (in.)	Height (in.)		
SCHD 1-0 x 6-8	S.S.	S.S.	S.S.	2.83	6.63
SCHD 1-6 x 6-8	S.S.	S.S.	S.S.	5.62	9.94
SCHD 2-0 x 6-8	11.37	21 13/32	76 1/2	7.40	13.25
SCHD 2-6 x 6-8	14.56	27 13/32	76 1/2	8.91	16.56
SCHD 2-9 x 6-8	16.16	30 13/32	76 1/2	10.31	18.22
SCHD 3-0 x 6-8	17.75	33 13/32	76 1/2	11.71	19.87
SCHD 3-0COM x 6-8	19.11	35 31/32	76 1/2	12.91	21.29
SCHD 1-0 x 6-11	S.S.	S.S.	S.S.	2.83	6.88
SCHD 1-6 x 6-11	S.S.	S.S.	S.S.	5.62	10.31
SCHD 2-0 x 6-11	11.82	21 13/32	79 1/2	7.40	13.75
SCHD 2-6 x 6-11	15.13	27 13/32	79 1/2	8.91	17.19
SCHD 2-9 x 6-11	16.79	30 13/32	79 1/2	10.31	18.91
SCHD 3-0 x 6-11	18.44	33 13/32	79 1/2	11.71	20.63
SCHD 3-0COM x 6-11	19.86	35 31/32	79 1/2	12.91	22.09
SCHD 1-0 x 7-3	S.S.	S.S.	S.S.	2.99	7.21
SCHD 1-6 x 7-3	S.S.	S.S.	S.S.	6.04	10.81
SCHD 2-0 x 7-3	12.41	21 13/32	83 1/2	7.95	14.42
SCHD 2-6 x 7-3	15.89	27 13/32	83 1/2	9.58	18.02
SCHD 2-9 x 7-3	17.63	30 13/32	83 1/2	11.08	19.82
SCHD 3-0 x 7-3	19.37	33 13/32	83 1/2	12.58	21.63
SCHD 3-0COM x 7-3	20.86	35 31/32	83 1/2	13.87	23.16
SCHD 1-0 x 8-0	S.S.	S.S.	S.S.	3.37	7.96
SCHD 1-6 x 8-0	S.S.	S.S.	S.S.	6.71	11.98
SCHD 2-0 x 8-0	13.75	21 13/32	92 1/2	8.83	15.92
SCHD 2-6 x 8-0	17.60	27 13/32	92 1/2	10.64	19.90
SCHD 2-9 x 8-0	19.53	30 13/32	92 1/2	12.31	21.89
SCHD 3-0 x 8-0	21.46	33 13/32	92 1/2	13.98	23.87
SCHD 3-0COM x 8-0	23.10	35 31/32	92 1/2	15.41	25.57
SCHD 2-6 x 9-0	19.89	27 13/32	104 1/2	12.23	22.40
SCHD 2-9 x 9-0	22.07	30 13/32	104 1/2	14.15	24.64
SCHD 3-0 x 9-0	24.24	33 13/32	104 1/2	16.07	26.88
SCHD 2-6 x 10-0	22.17	27 13/32	116 1/2	13.83	24.90
SCHD 2-9 x 10-0	24.60	30 13/32	116 1/2	16.00	27.39
SCHD 3-0 x 10-0	27.03	33 13/32	116 1/2	18.17	29.88

Note: S.S. denotes Stationary Sidelite.

For Multi-Panel units: The vent opening, daylight opening, and unit size can be determined by adding the figures for the constituent panels.

FRENCH SWING DOORS

Unit No.	Sq. Ft. Vent & Clear Opening	Clear Opening		Sq. Ft. Daylight Opening Per Panel	Sq. Ft. Unit
		Width (in.)	Height (in.)		
SCHD 4-0 x 6-8F	23.54	44 5/16	76 1/2	7.40	26.50
SCHD 5-0 x 6-8F	29.91	56 5/16	76 1/2	8.91	33.12
SCHD 5-6 x 6-8F	33.10	62 5/16	76 1/2	10.31	36.48
SCHD 6-0 x 6-8F	36.29	68 5/16	76 1/2	11.71	39.75
SCHD 4-0 x 6-11F	24.46	44 5/16	79 1/2	7.40	27.50
SCHD 5-0 x 6-11F	31.09	56 5/16	79 1/2	8.91	34.37
SCHD 5-6 x 6-11F	34.40	62 5/16	79 1/2	10.31	37.81
SCHD 6-0 x 6-11F	37.71	68 5/16	79 1/2	11.71	41.25
SCHD 4-0 x 7-3F	25.70	44 5/16	83 1/2	7.95	28.84
SCHD 5-0 x 7-3F	32.65	56 5/16	83 1/2	9.58	36.04
SCHD 5-6 x 7-3F	36.13	62 5/16	83 1/2	11.08	39.64
SCHD 6-0 x 7-3F	39.61	68 5/16	83 1/2	12.58	43.26
SCHD 4-0 x 8-0F	28.46	44 5/16	92 1/2	8.83	31.83
SCHD 5-0 x 8-0F	36.17	56 5/16	92 1/2	10.64	39.79
SCHD 5-6 x 8-0F	40.03	62 5/16	92 1/2	12.31	43.77
SCHD 6-0 x 8-0F	43.88	68 5/16	92 1/2	13.98	47.75
SCHD 5-0 x 9-0F	40.87	56 5/16	104 1/2	12.23	44.80
SCHD 5-6 x 9-0F	45.22	62 5/16	104 1/2	14.15	49.28
SCHD 6-0 x 9-0F	49.57	68 5/16	104 1/2	16.07	53.76
SCHD 5-0 x 10-0F	45.56	56 5/16	116 1/2	13.83	49.80
SCHD 5-6 x 10-0F	50.41	62 5/16	116 1/2	16.00	54.78
SCHD 6-0 x 10-0F	55.27	68 5/16	116 1/2	18.17	59.76

Note: French Swing Door Daylight Openings are square foot per panel.

CLEAR OPENING AND DAYLIGHT SPECIFICATIONS

PINE BOTTOM SWING DOORS

Unit No.	Sq. Ft. Vent & Clear Opening	Clear Opening		Sq. Ft. Daylight Opening Per Panel	Sq. Ft. Unit
		Width (in.)	Height (in.)		
SCHD 1-6 x 6-8	S.S.	S.S.	S.S.	3.12	9.94
SCHD 2-6 x 6-8	14.56	27 13/32	76 1/2	4.94	16.56
SCHD 2-9 x 6-8	16.15	30 13/32	76 1/2	5.71	18.22
SCHD 3-0 x 6-8	17.75	33 13/32	76 1/2	6.49	19.87
SCHD 3-0 x 6-8 COM	19.11	35 31/32	76 1/2	7.15	21.29
SCHD 1-6 x 6-11	S.S.	S.S.	S.S.	3.12	10.31
SCHD 2-6 x 6-11	15.13	27 13/32	79 1/2	4.94	17.19
SCHD 2-9 x 6-11	16.79	30 13/32	79 1/2	5.71	18.91
SCHD 3-0 x 6-11	18.44	33 13/32	79 1/2	6.49	20.63
SCHD 3-0 x 6-11 COM	19.86	35 31/32	79 1/2	7.15	22.09
SCHD 1-6 x 7-3	S.S.	S.S.	S.S.	S.S.	10.81
SCHD 2-6 x 7-3	15.89	27 13/32	83 1/2	5.47	18.02
SCHD 2-9 x 7-3	17.63	30 13/32	83 1/2	6.33	19.82
SCHD 3-0 x 7-3	19.37	33 13/32	83 1/2	7.19	21.63
SCHD 3-0 x 7-3 COM	20.86	35 31/32	83 1/2	7.92	23.16
SCHD 1-6 x 8-0	S.S.	S.S.	S.S.	4.2	11.98
SCHD 2-6 x 8-0	17.60	27 13/32	92 1/2	6.67	19.9
SCHD 2-9 x 8-0	19.53	30 13/32	92 1/2	7.71	21.89
SCHD 3-0 x 8-0	21.46	33 13/32	92 1/2	8.76	23.87
SCHD 3-0 x 8-0 COM	23.11	35 31/32	92 1/2	9.65	25.57

Note: S.S. denotes Stationary Sidelite.

SECTOR TOP SWING DOORS

Unit No.	Sq. Ft. Vent & Clear Opening	Clear Opening		Sq. Ft. Daylight Opening Per Panel	Sq. Ft. Unit
		Width (in.)	Height (in.)		
SCHD 2-6 x 6-8	12.69	27 13/32	66 21/32	8.48	15.42
SCHD 2-9 x 6-8	14.07	30 13/32	66 21/32	9.81	16.96
SCHD 3-0 x 6-8	15.46	33 13/32	66 21/32	11.15	18.50
SCHD 3-0 x 6-8 COM	16.65	35 31/32	66 21/32	12.28	19.82
SCHD 2-6 x 6-11	13.26	27 13/32	69 21/32	8.48	16.04
SCHD 2-9 x 6-11	14.71	30 13/32	69 21/32	9.81	17.65
SCHD 3-0 x 6-11	16.16	33 13/32	69 21/32	11.15	19.25
SCHD 3-0 x 6-11 COM	17.40	35 31/32	69 21/32	12.28	20.62
SCHD 2-6 x 7-3	14.02	27 13/32	73 21/32	8.98	16.88
SCHD 2-9 x 7-3	15.55	30 13/32	73 21/32	10.39	18.56
SCHD 3-0 x 7-3	17.09	33 13/32	73 21/32	11.80	20.25
SCHD 3-0 x 7-3 COM	18.40	35 31/32	73 21/32	13.00	21.69
SCHD 2-6 x 8-0	15.73	27 13/32	82 21/32	10.21	18.75
SCHD 2-9 x 8-0	17.45	30 13/32	82 21/32	11.81	30.63
SCHD 3-0 x 8-0	19.18	33 13/32	82 21/32	13.41	22.50
SCHD 3-0 x 8-0 COM	20.65	35 31/32	82 21/32	14.78	24.10
SCHD 2-6 x 9-0F	18.01	27 13/32	94 21/32	11.77	21.46
SCHD 2-9 x 9-0F	19.99	30 13/32	94 21/32	13.62	23.60
SCHD 3-0 x 9-0F	21.96	33 13/32	94 21/32	15.46	25.75
SCHD 2-6 x 10-0F	20.30	27 13/32	106 21/32	13.37	23.46
SCHD 2-9 x 10-0F	22.52	30 13/32	106 21/32	15.46	26.35
SCHD 3-0 x 10-0F	24.74	33 13/32	106 21/32	17.56	28.75

**UNIT SIZING, ROUGH OPENINGS & MASONRY OPENINGS:
IN-SWING PATIO DOORS**

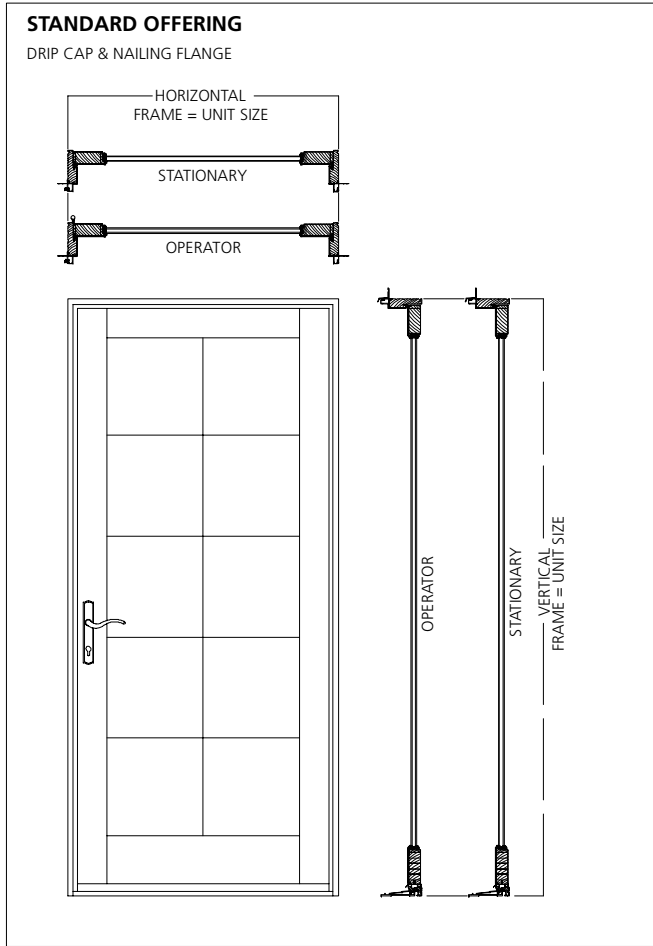

GENERAL NOTES:

UNITS WITH NO EXTERIOR TRIM
OR DRIP CAP & NAILING FLANGE:
FRAME SIZE = UNIT SIZE

UNIT SIZE IS ALWAYS THE
EXTREME SIZE OF THE DOOR
WITH OR WITHOUT TRIM
(DRIP CAP & NAILING FLANGE ARE
NOT ADDED TO ANY UNIT SIZING)

ROUGH OPENING IS ALWAYS 3/4" OVER
FRAME SIZE OF THE DOOR

MASONRY OPENING IS ALWAYS 1/2"
OVER THE UNIT SIZE OF THE DOOR

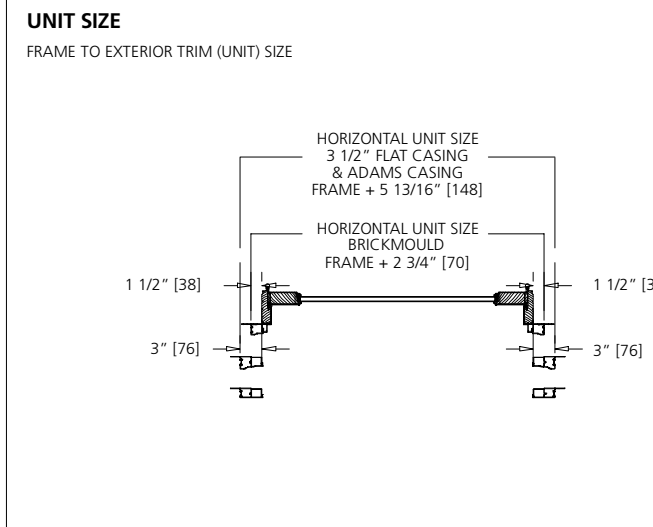
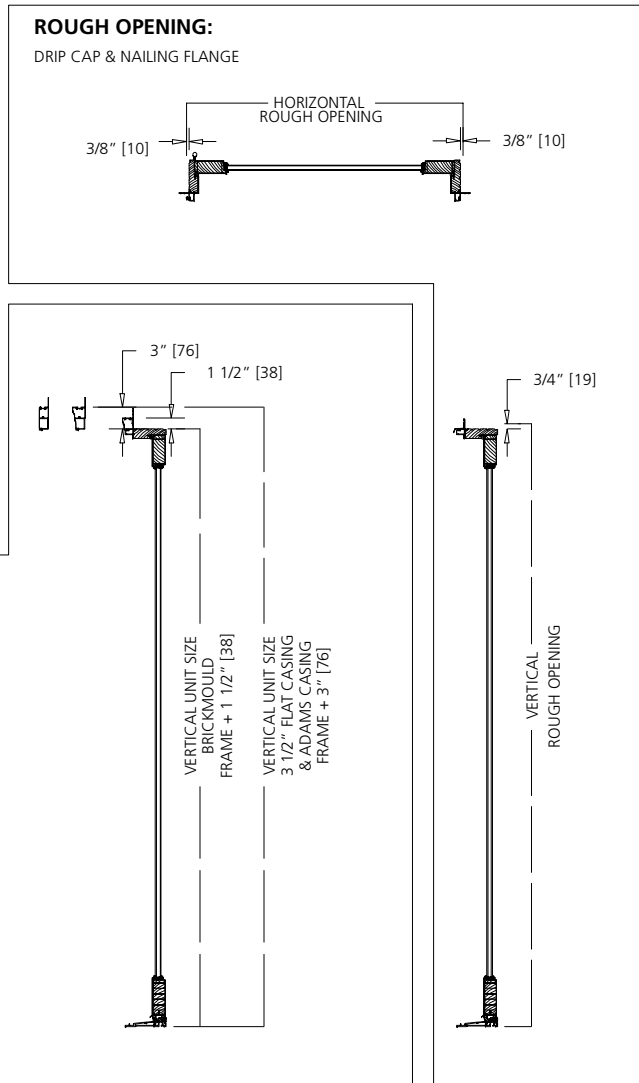

**UNIT SIZING, ROUGH OPENINGS & MASONRY OPENINGS:
OUT-SWING PATIO DOORS**

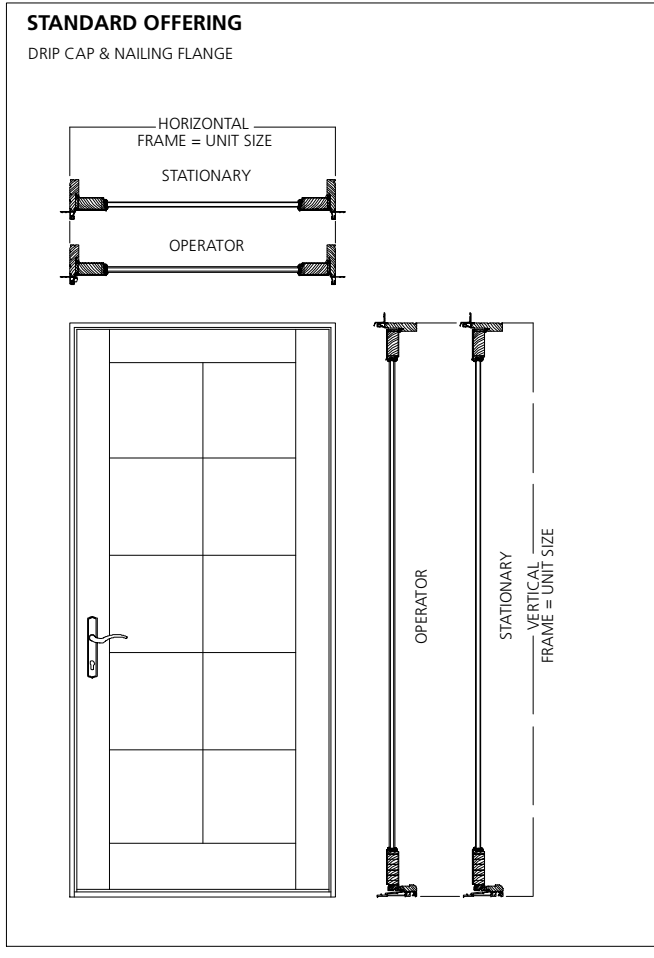

GENERAL NOTES:

UNITS WITH NO EXTERIOR TRIM
OR DRIP CAP & NAILING FLANGE:
FRAME SIZE = UNIT SIZE

UNIT SIZE IS ALWAYS THE
EXTREME SIZE OF THE DOOR
WITH OR WITHOUT TRIM
(DRIP CAP & NAILING FLANGE ARE
NOT ADDED TO ANY UNIT SIZING)

ROUGH OPENING IS ALWAYS 3/4" OVER
FRAME SIZE OF THE DOOR

MASONRY OPENING IS ALWAYS 1/2"

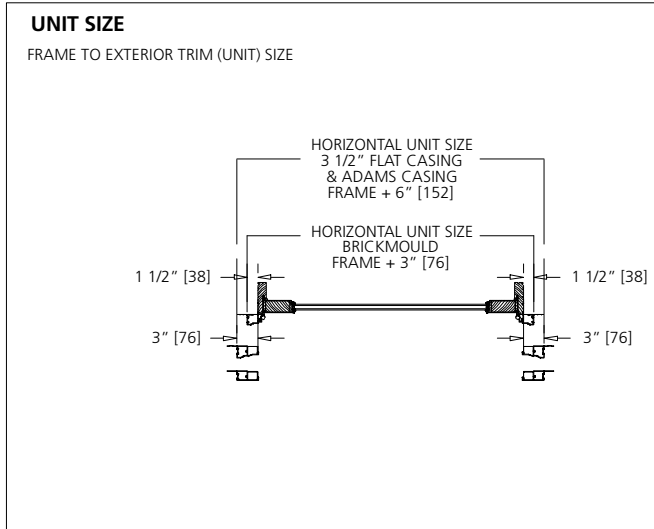
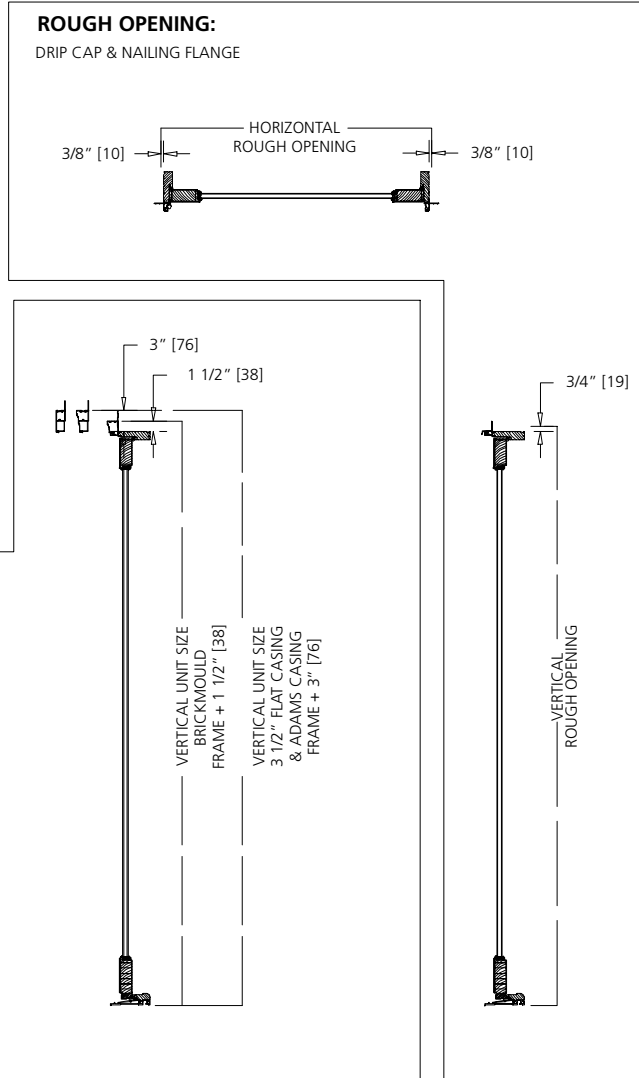

SINGLE IN-SWING

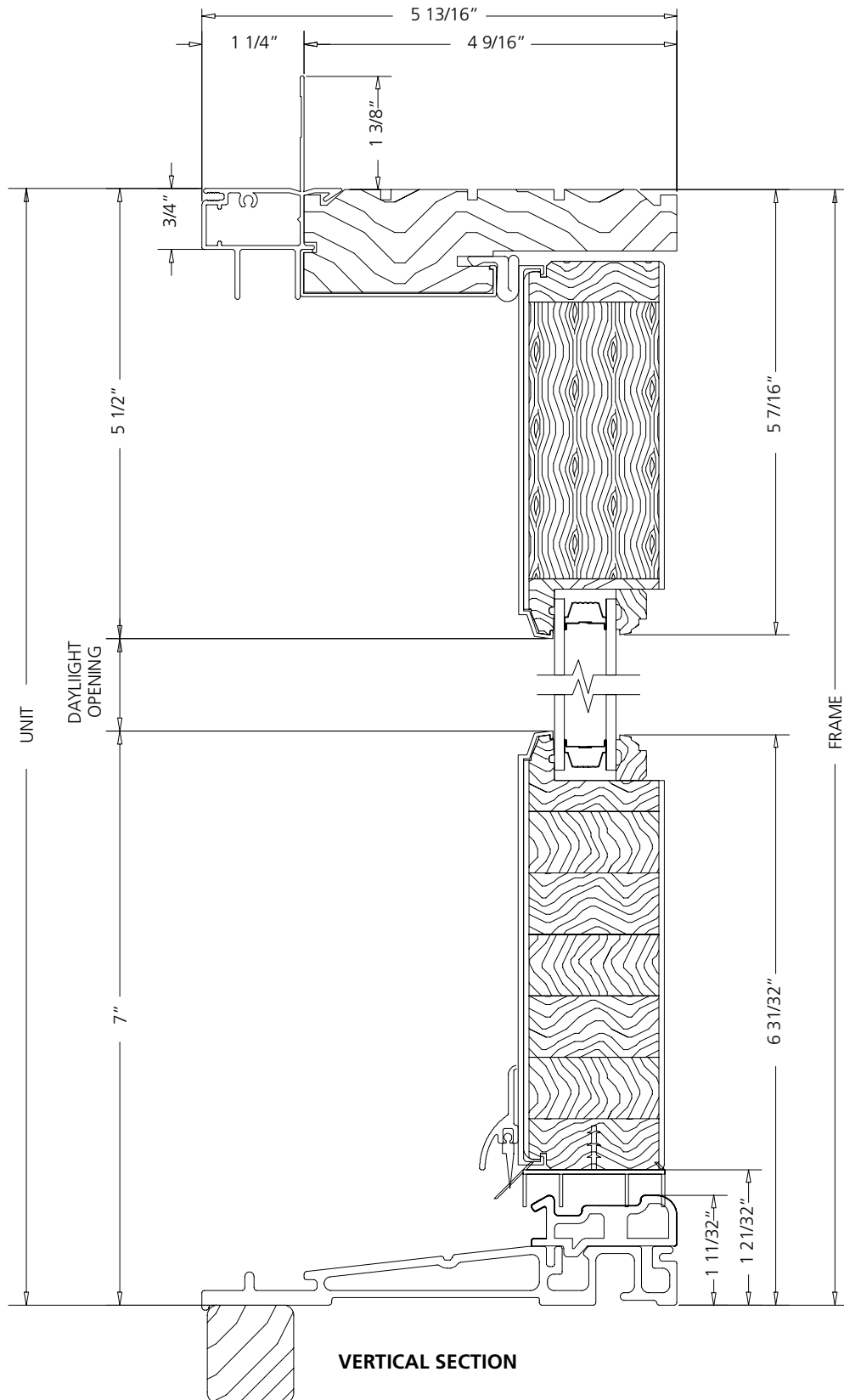

Note: Bottom rail shown is for 6'-8" doors. Bottom rail is 3" taller for doors over 6'-8".

SCALE: 6" = 1'

SINGLE IN-SWING

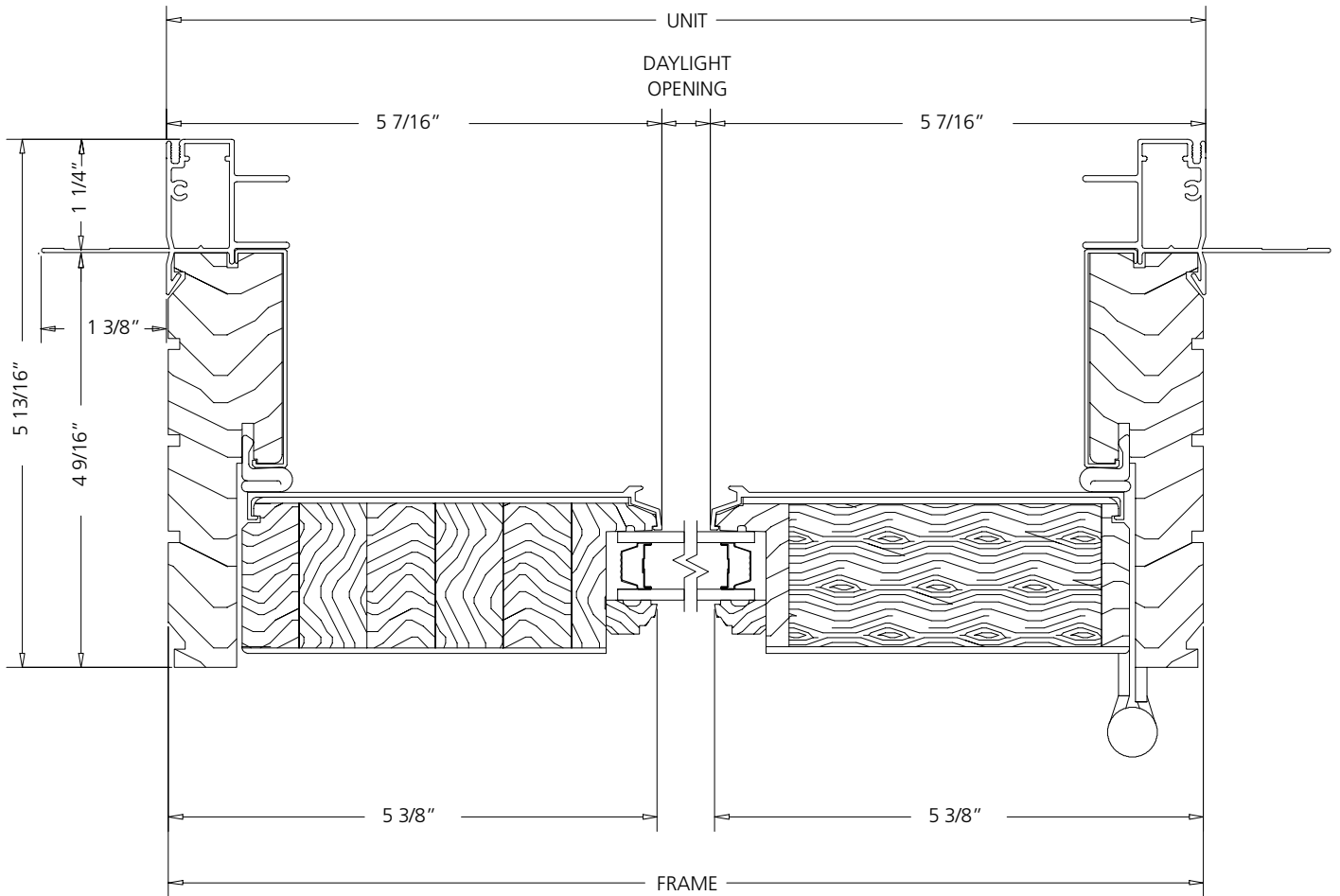

HORIZONTAL SECTION

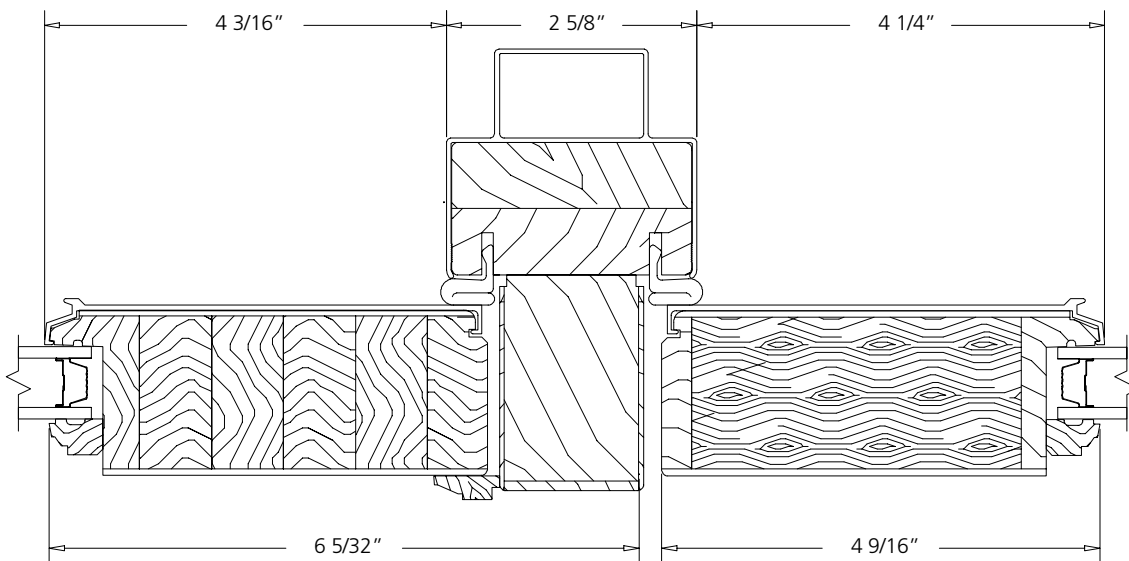

**POST SECTION
VIEW A-A**

VIEW A-A

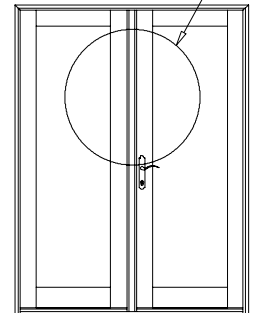

SCALE: 6" = 1'

SIDELIGHT IN-SWING

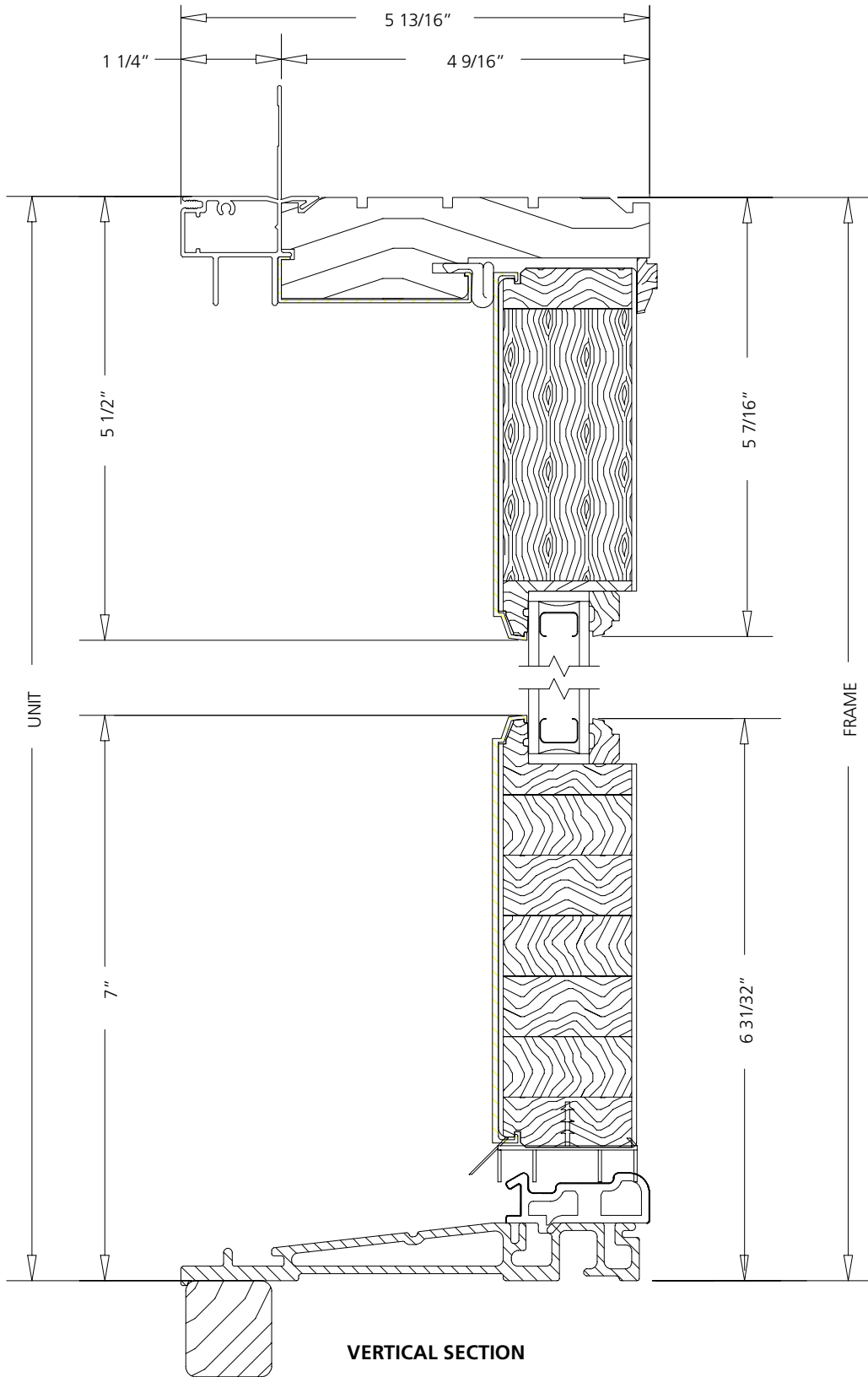

Note: Bottom rail shown is for 6'-8" doors. Bottom rail is 3" taller for doors over 6'-8".

SCALE: 6" = 1'

SIDELIGHT IN-SWING

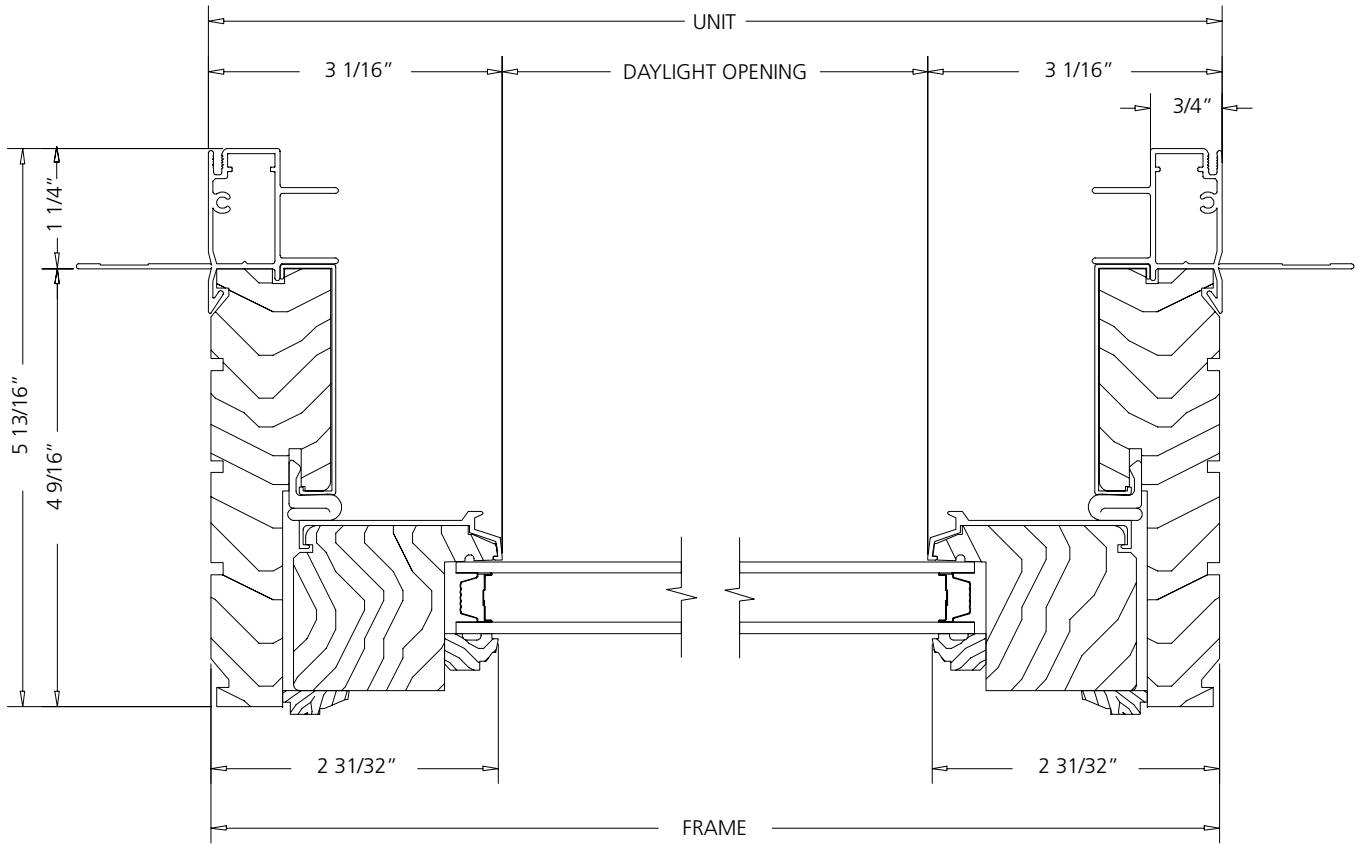

HORIZONTAL SECTION

SCALE: 6" = 1'

SINGLE SWING OUT-SWING

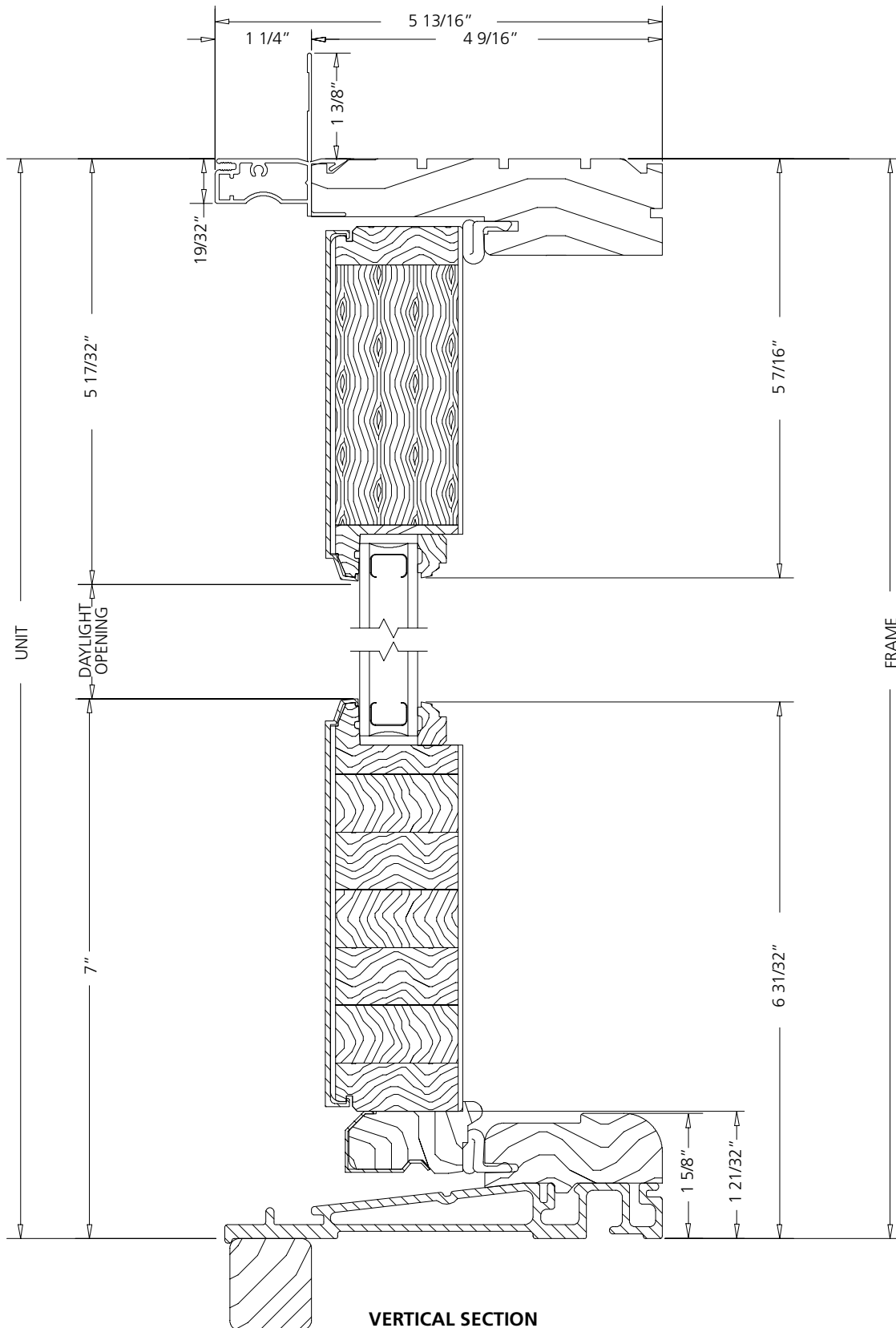

Note: Bottom rail shown is for 6'-8" doors. Bottom rail is 3" taller for doors over 6'-8".

SCALE: 6" = 1'

SINGLE SWING OUT-SWING

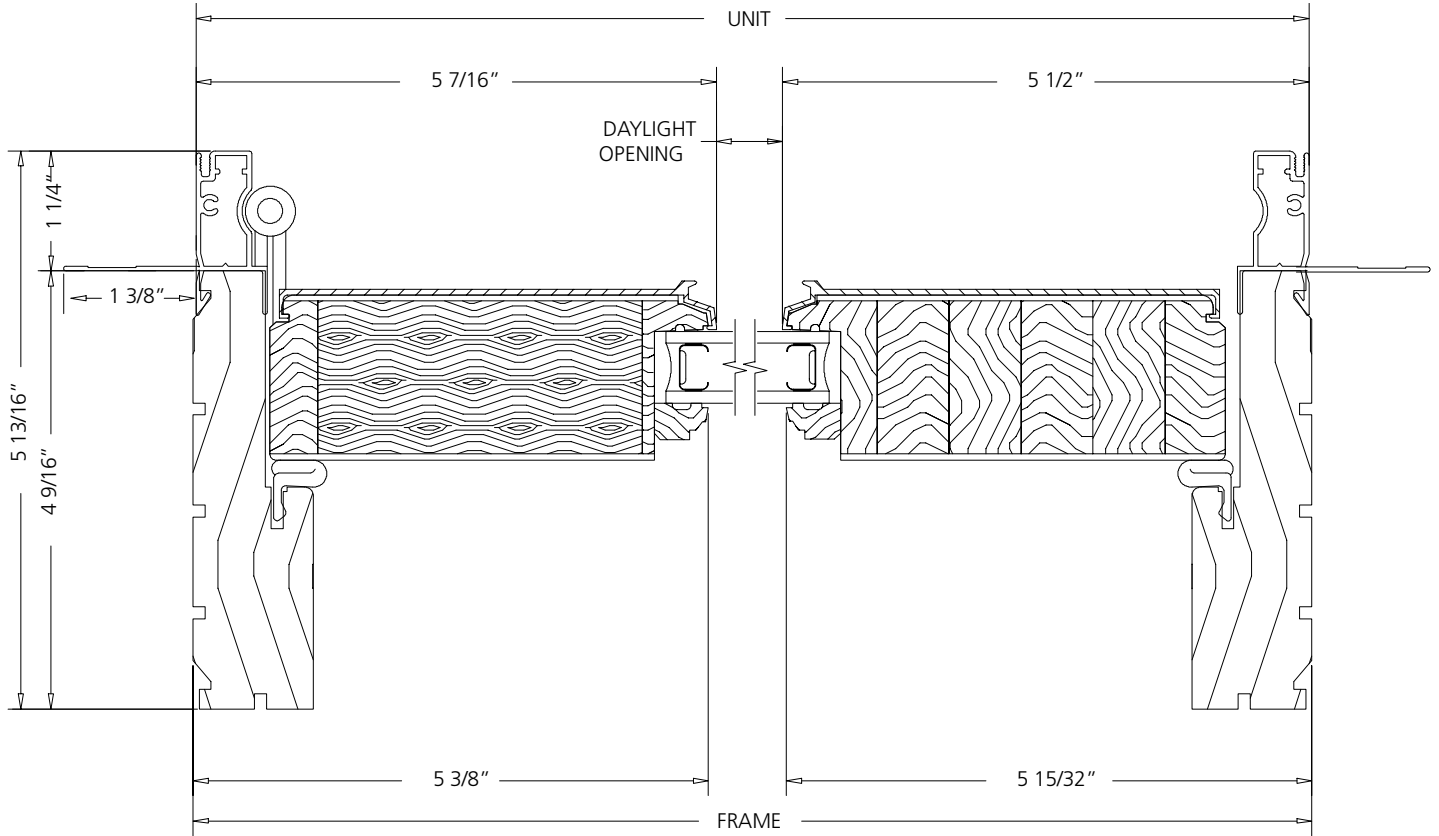

HORIZONTAL SECTION

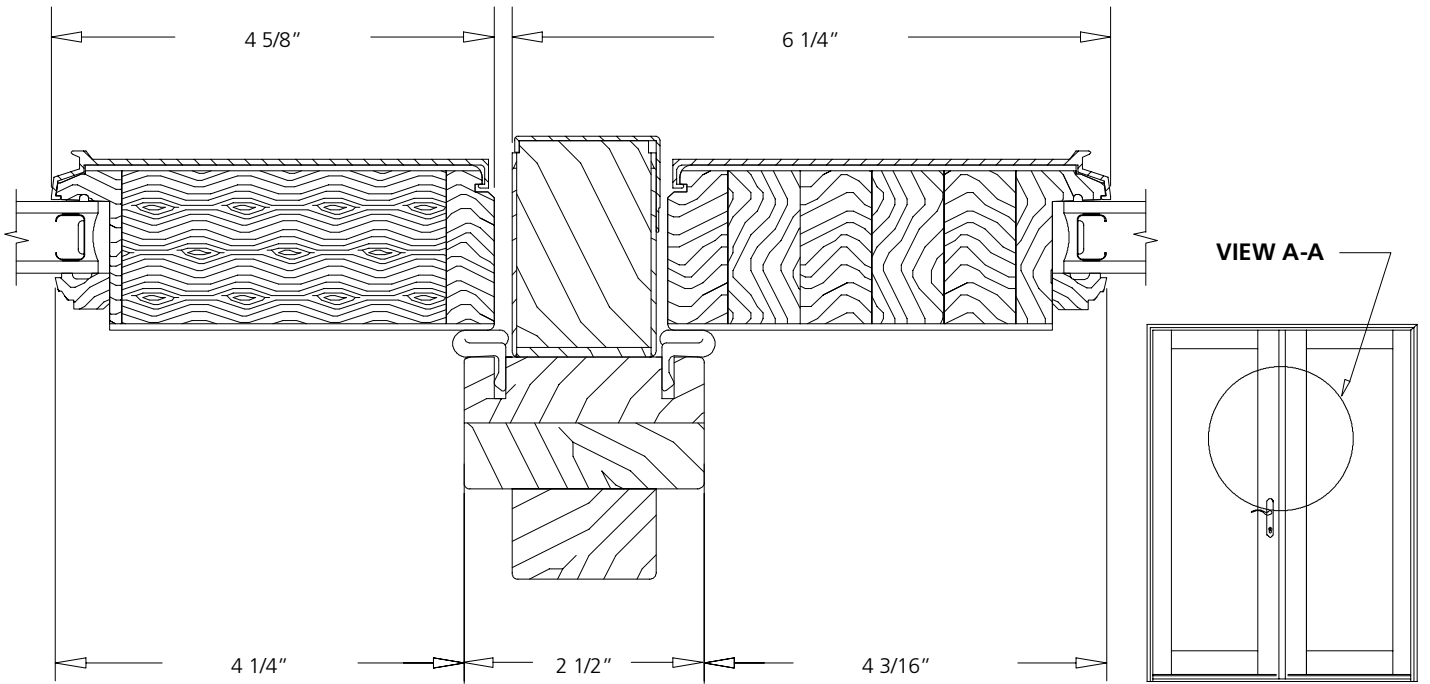

**POST SECTION
VIEW A-A
HORIZONTAL SECTION**

SCALE: 6" = 1'

SIDLIGHT OUT-SWING

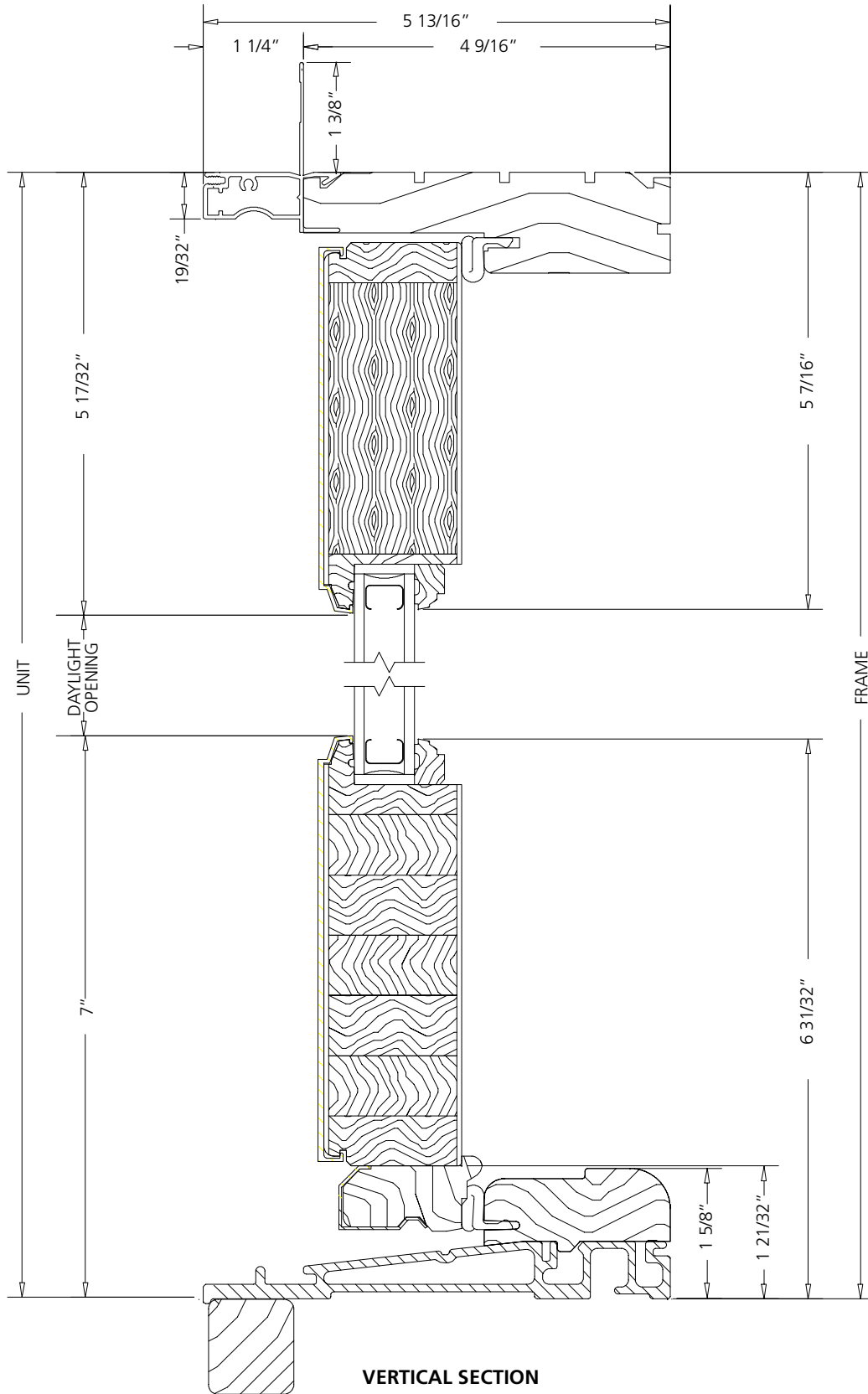

Note: Bottom rail shown is for 6'-8" doors. Bottom rail is 3" taller for doors over 6'-8".

SCALE: 6" = 1'

SIDLIGHT OUT-SWING

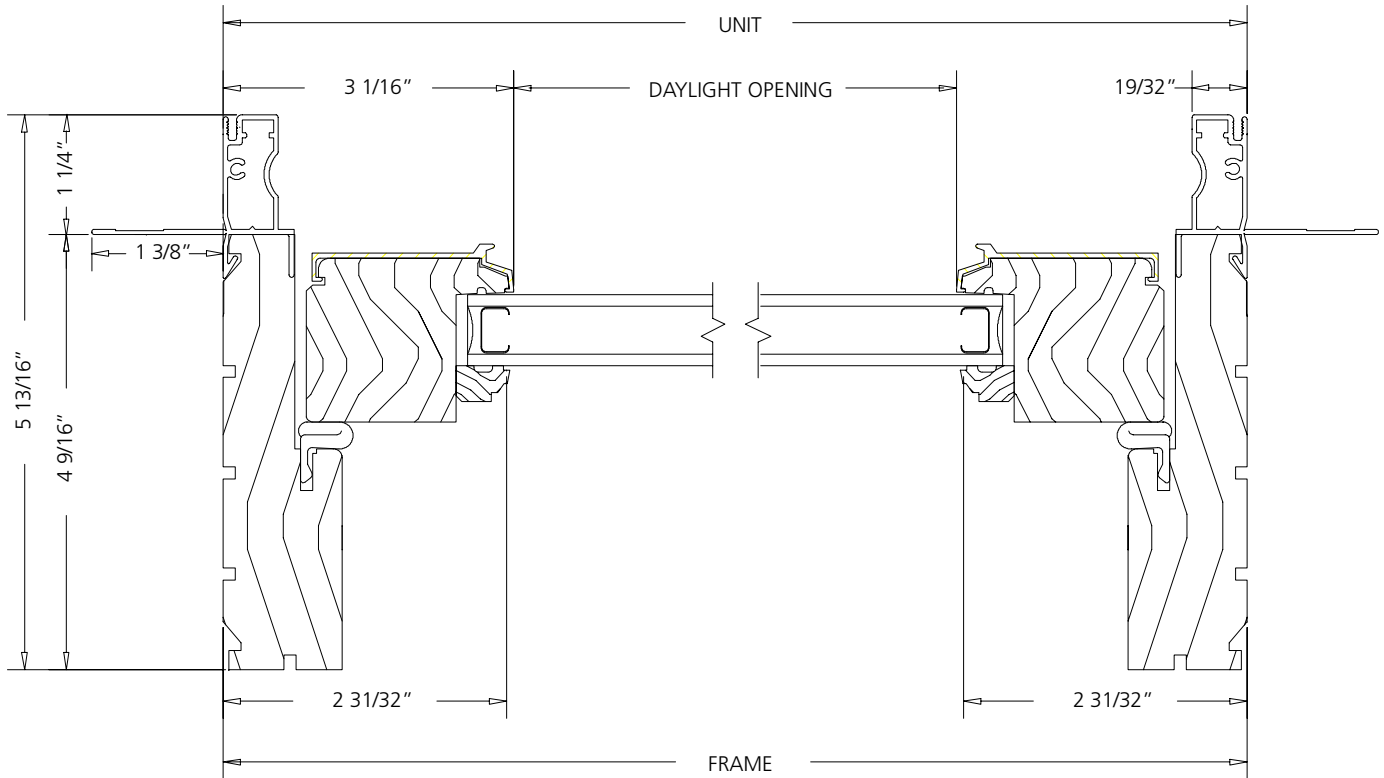

HORIZONTAL SECTION

SCALE: 6" = 1'

FRENCH IN-SWING

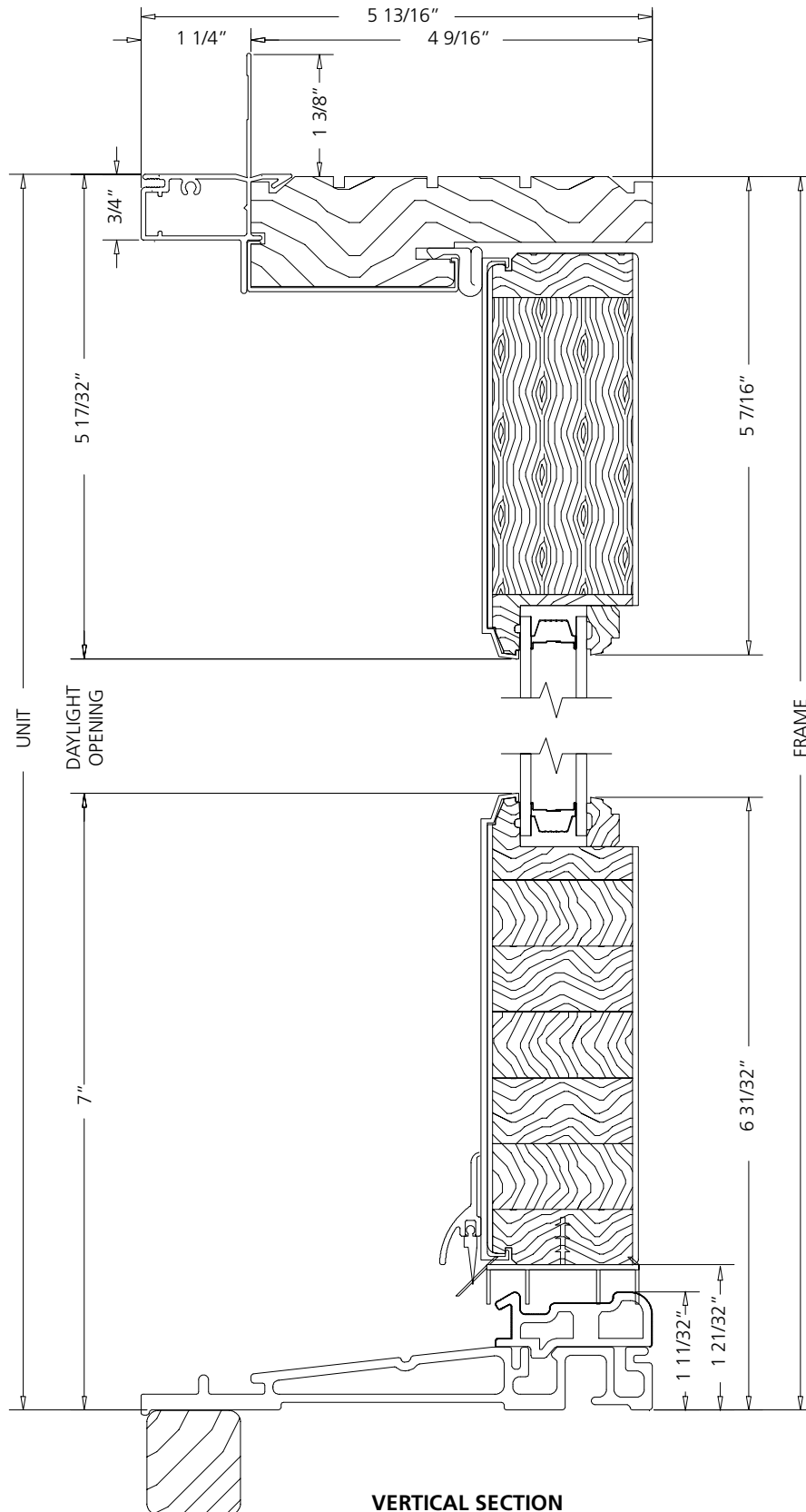

VERTICAL SECTION

Note: Bottom rail shown is for 6'-8" doors. Bottom rail is 3" taller for doors over 6'-8".

SCALE: 6" = 1'

FRENCH IN-SWING

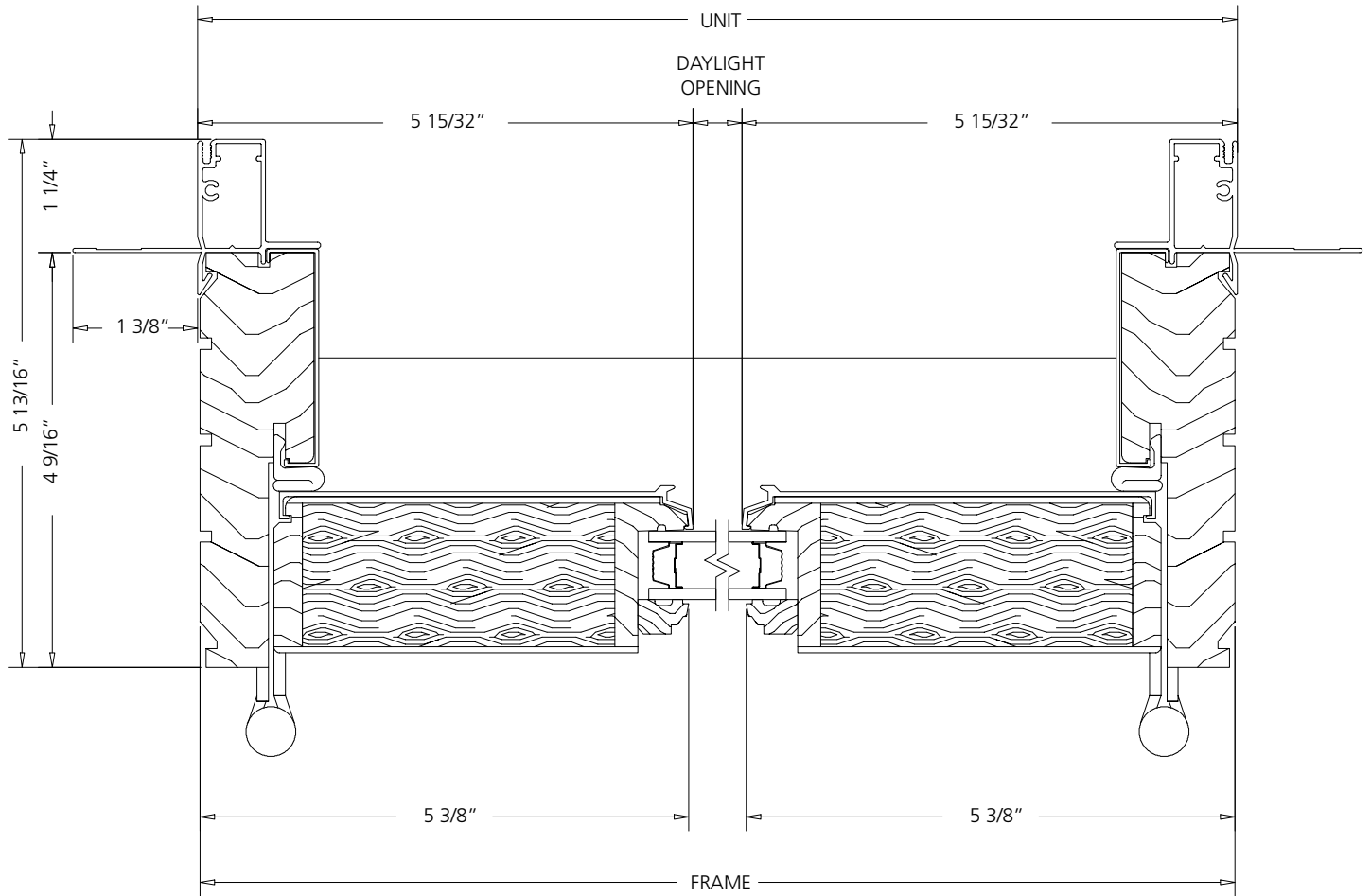

HORIZONTAL SECTION

SCALE: 6" = 1'

4-0 FRENCH IN-SWING

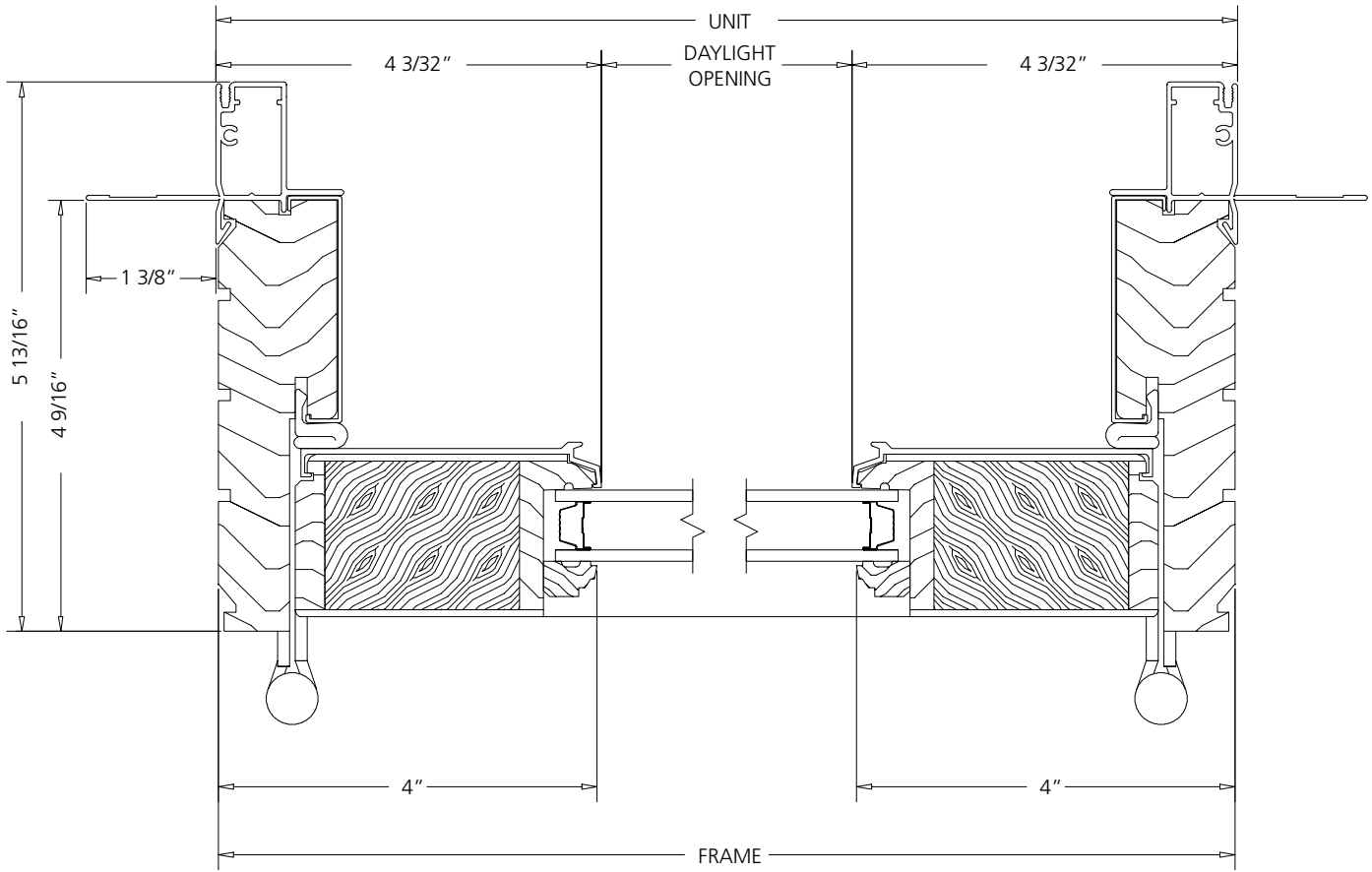

HORIZONTAL SECTION

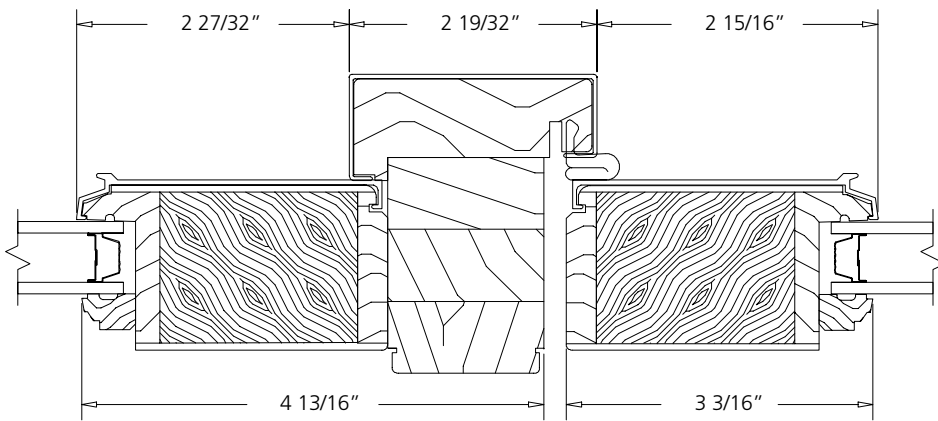

**ASTRAGAL SECTION
VIEW A-A**

VIEW A-A

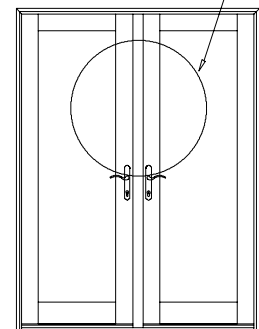

SCALE: 6" = 1'

FRENCH OUT-SWING

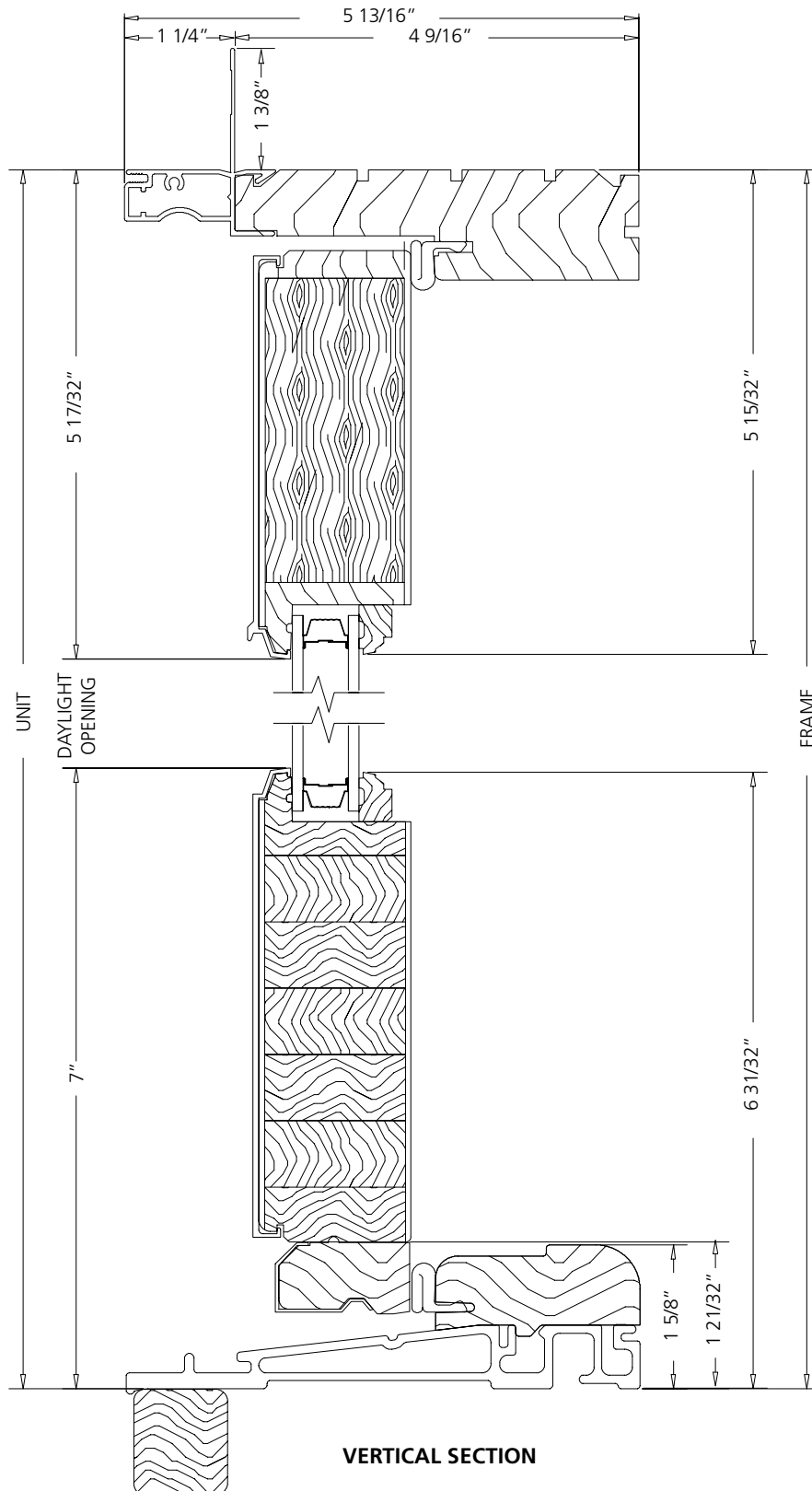

Note: Bottom rail shown is for 6'-8" doors. Bottom rail is 3" taller for doors over 6'-8".

SCALE: 6" = 1'

FRENCH OUT-SWING

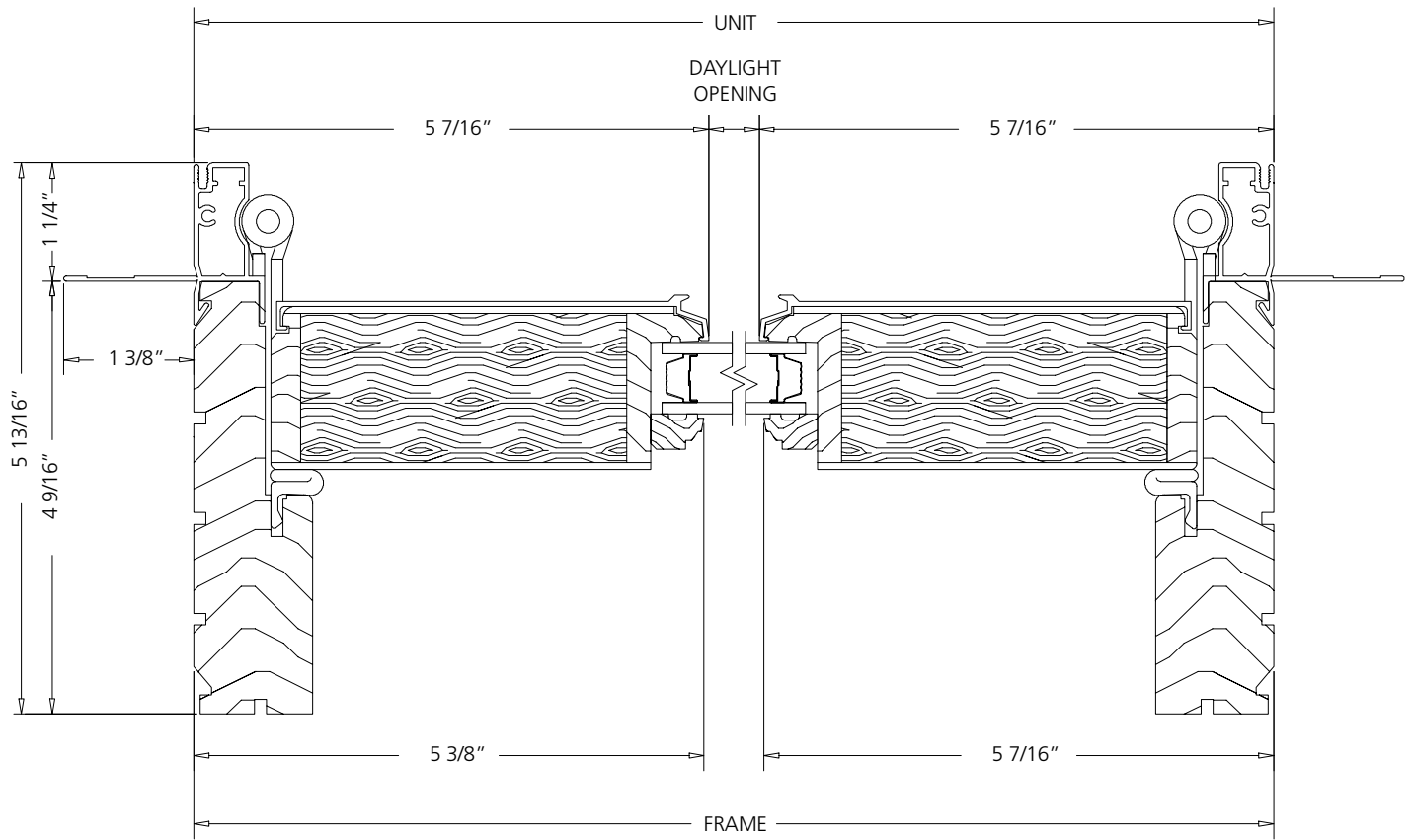

HORIZONTAL SECTION

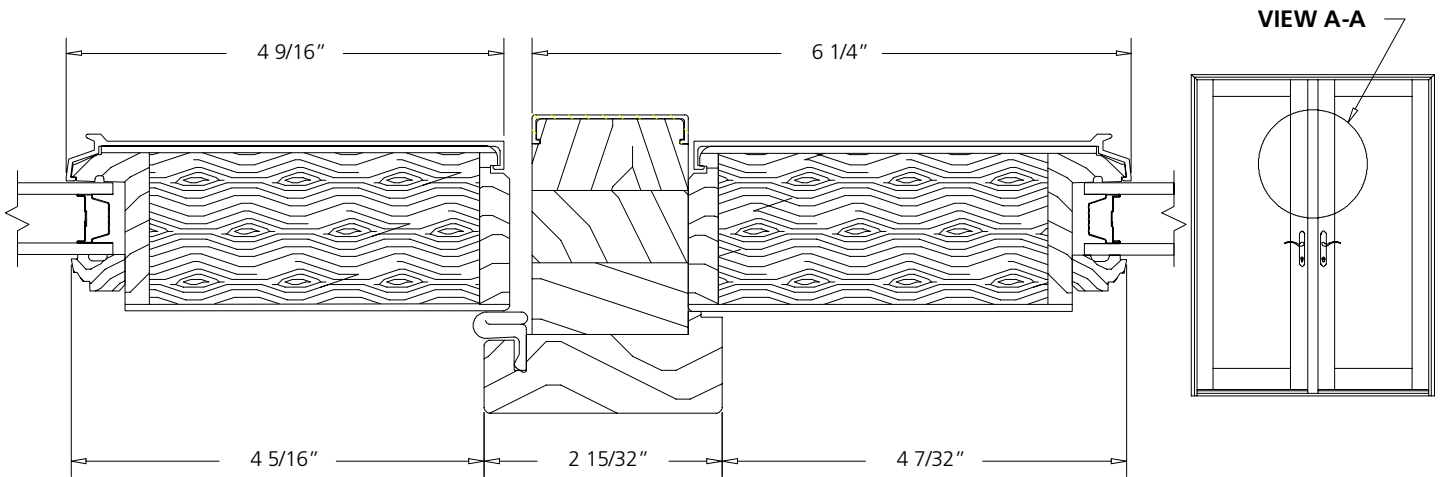

**ASTRAGAL HORIZONTAL SECTION
VIEW A-A**

SCALE: 6" = 1'

4-0 FRENCH OUT-SWING

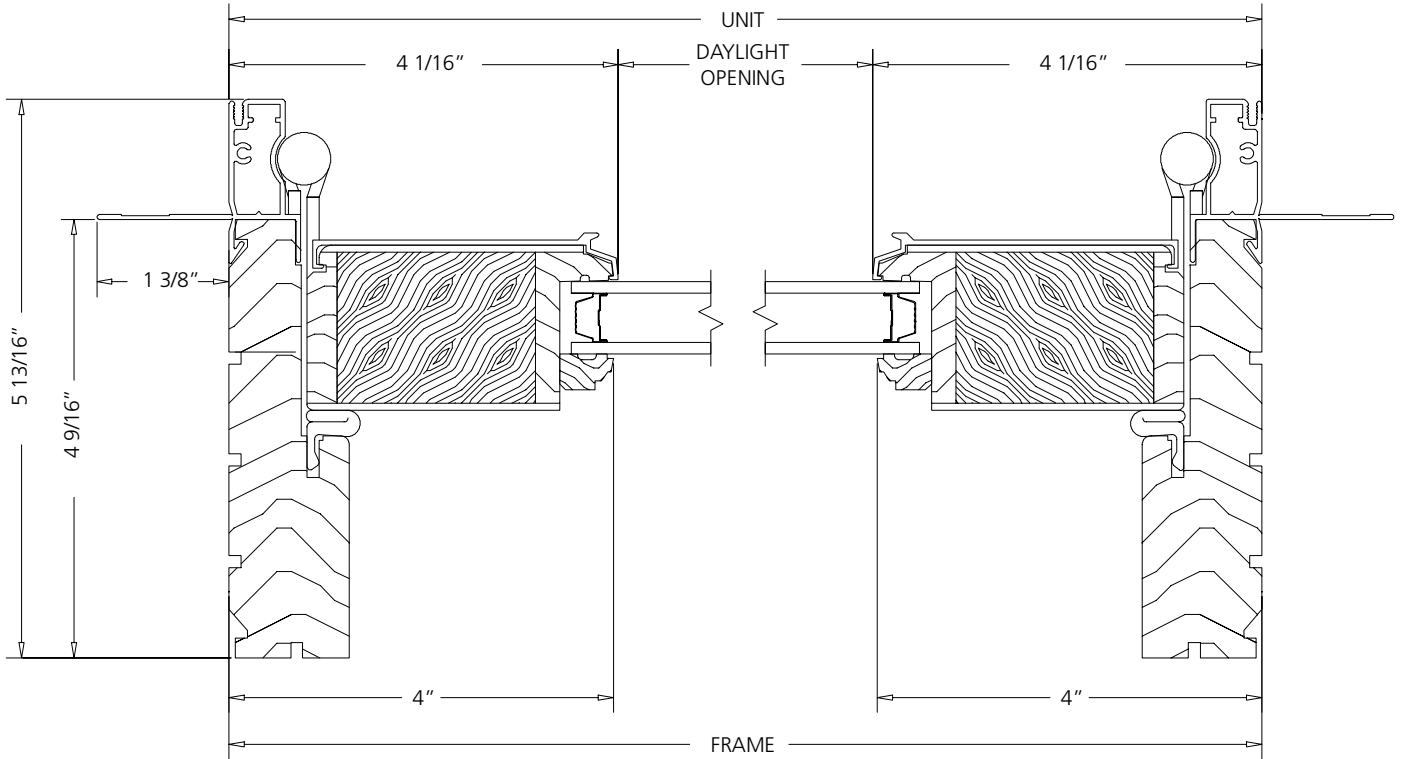

HORIZONTAL SECTION

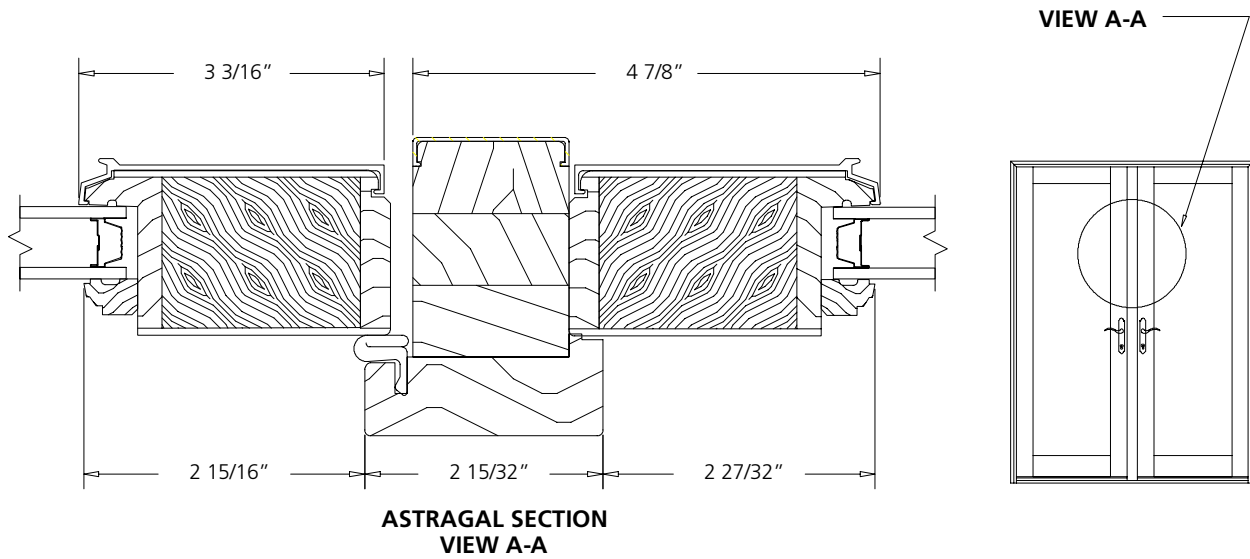

**ASTRAGAL SECTION
VIEW A-A**

SCALE: 6" = 1'

TRANSOM

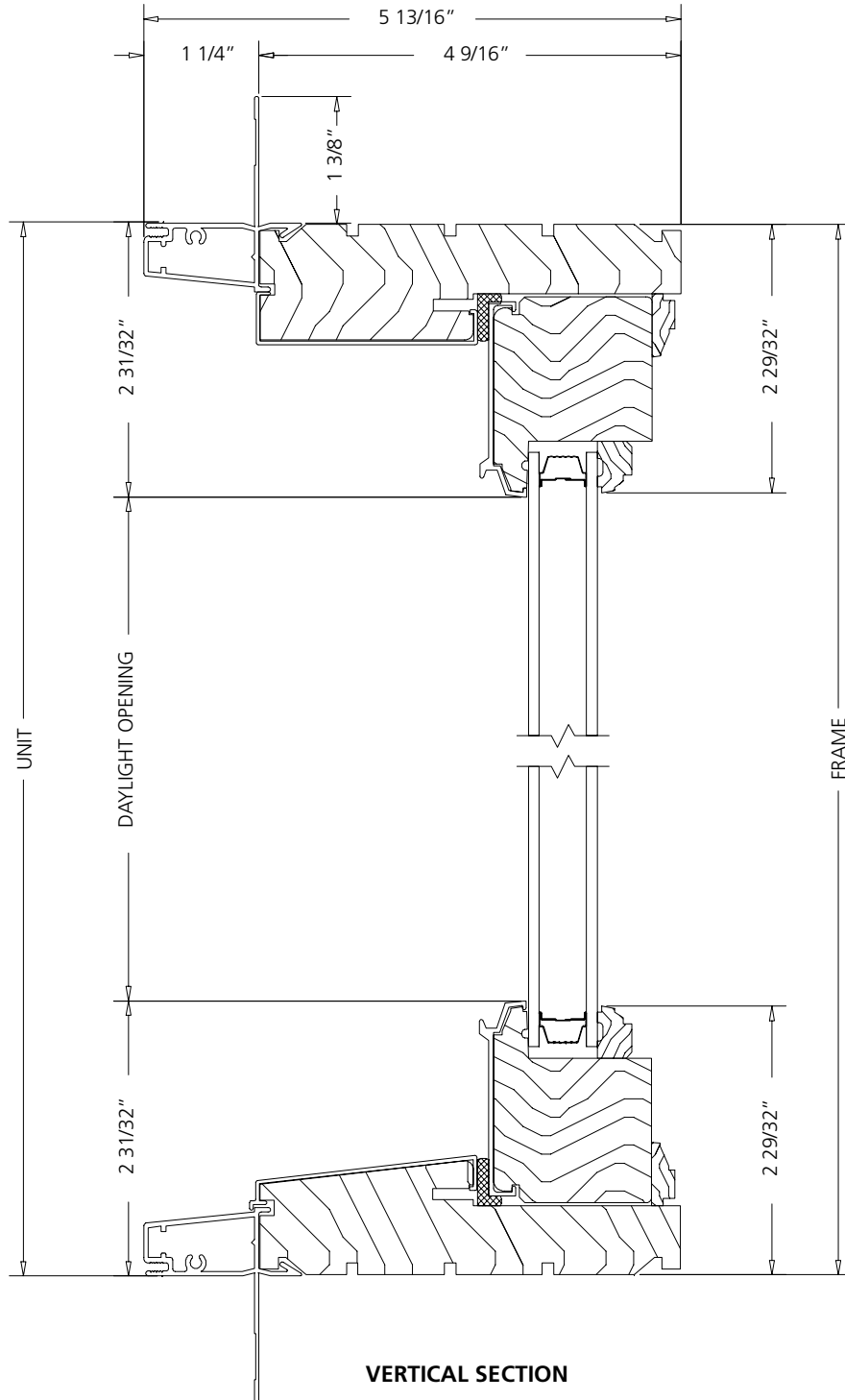

SCALE: 6" = 1'

TRANSOM

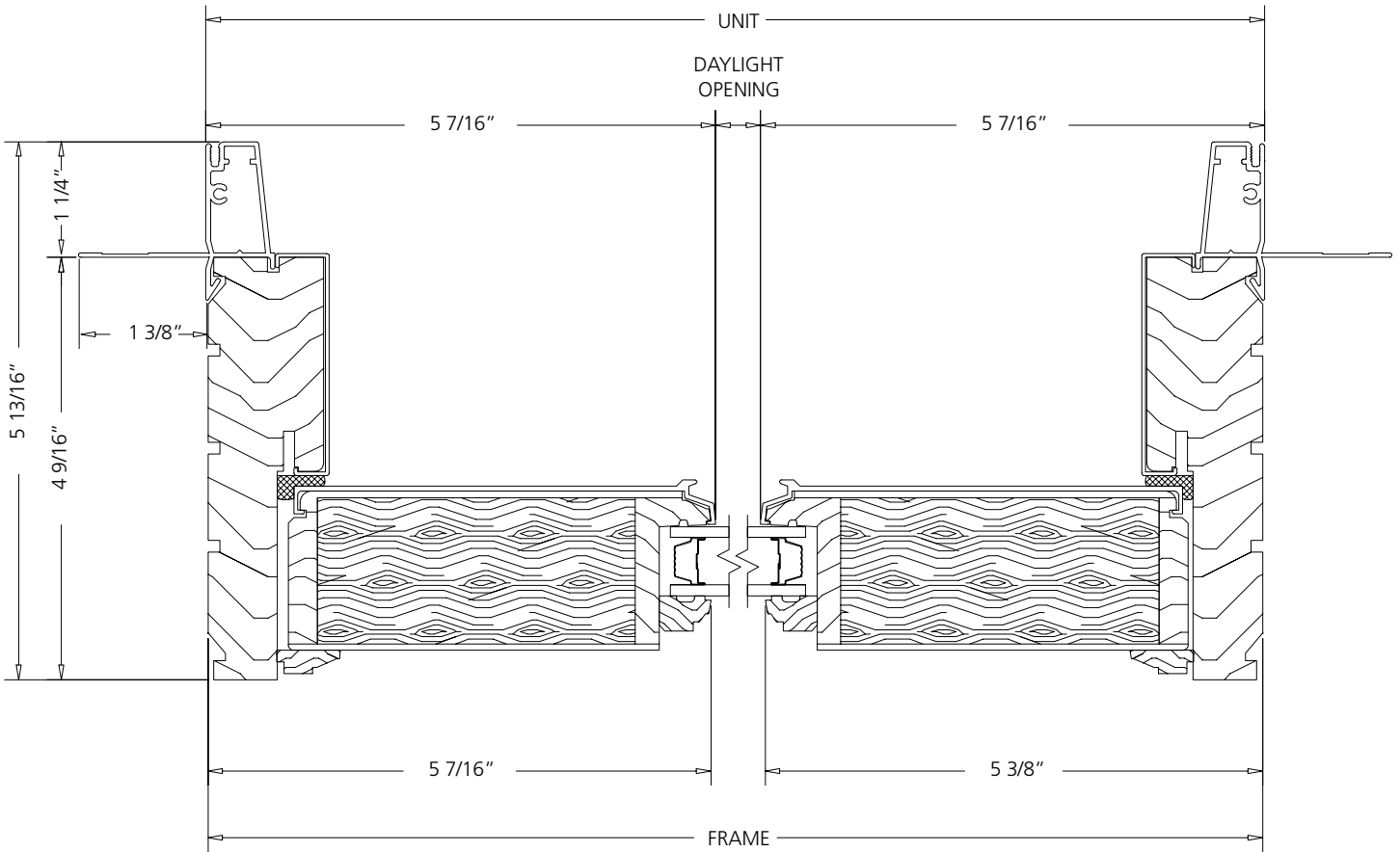

HORIZONTAL SECTION

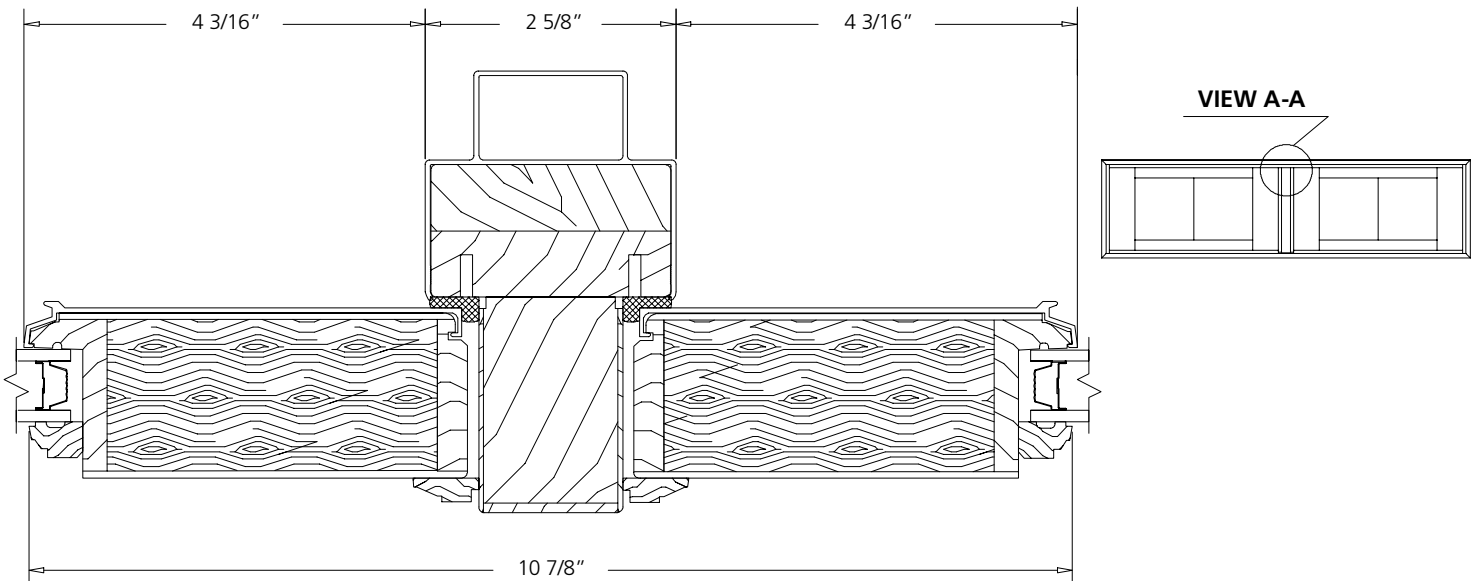

**ASTRAGAL SECTION
VIEW A-A**

SCALE: 6" = 1'

SWING DOOR BOTTOM RAIL OPTIONS

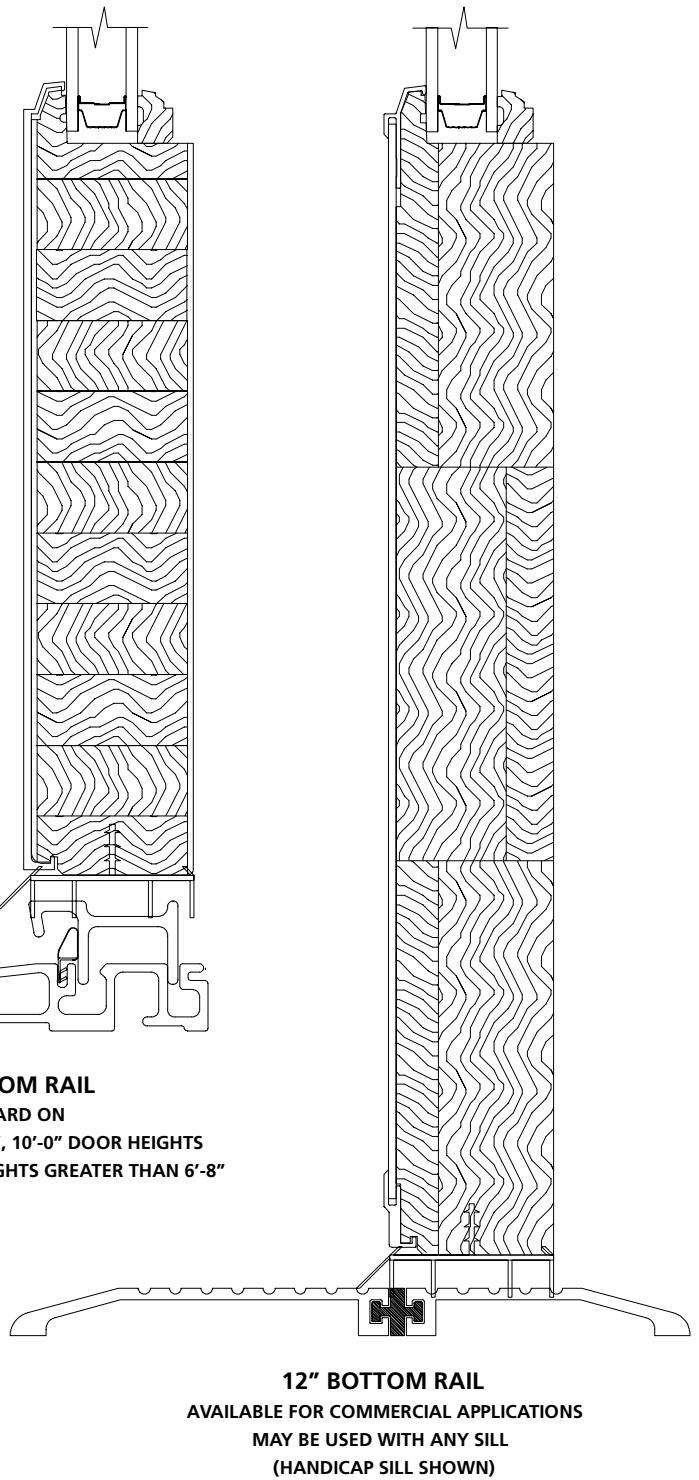
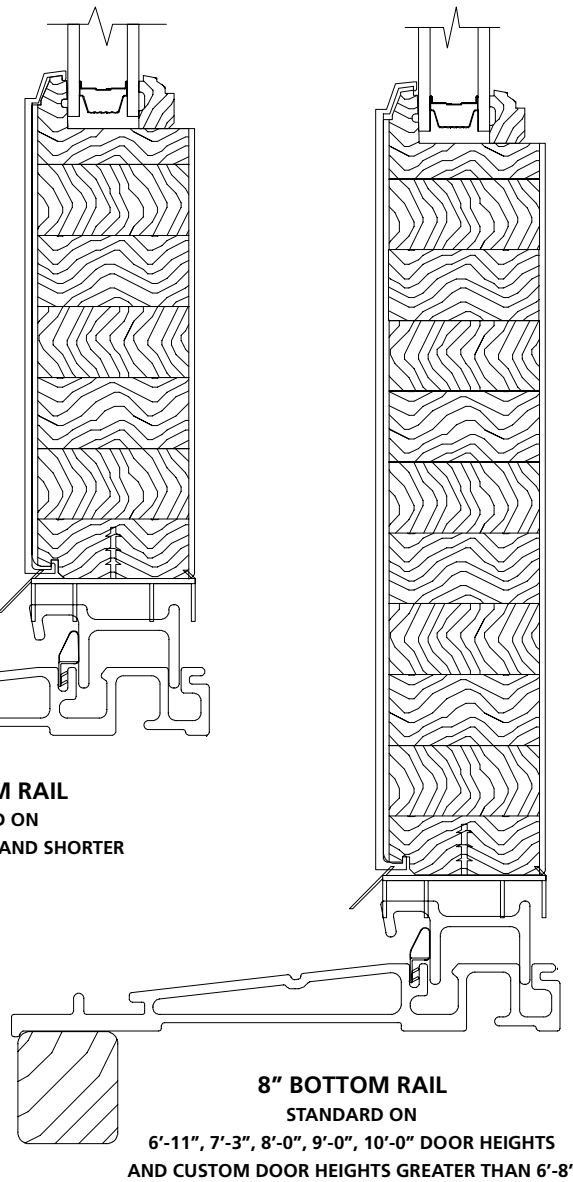
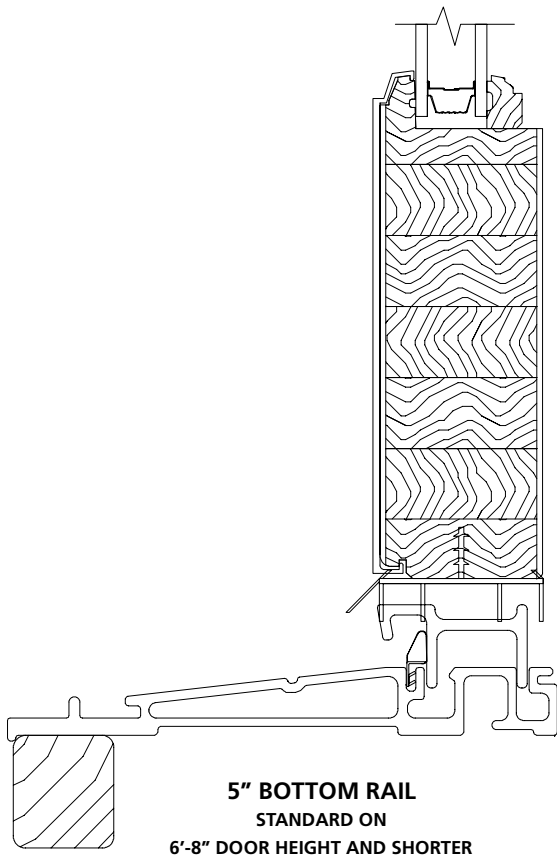

SCALE: 6" = 1'

STANDARD SILL OPTIONS

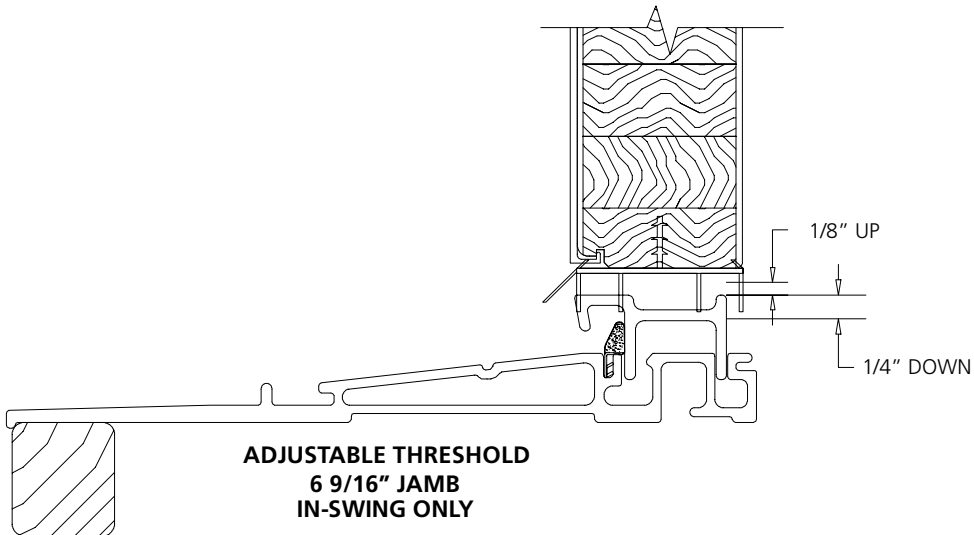
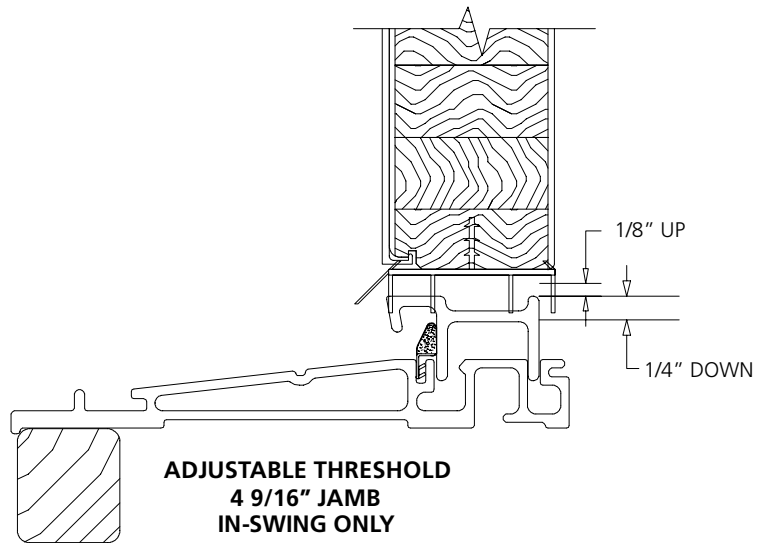
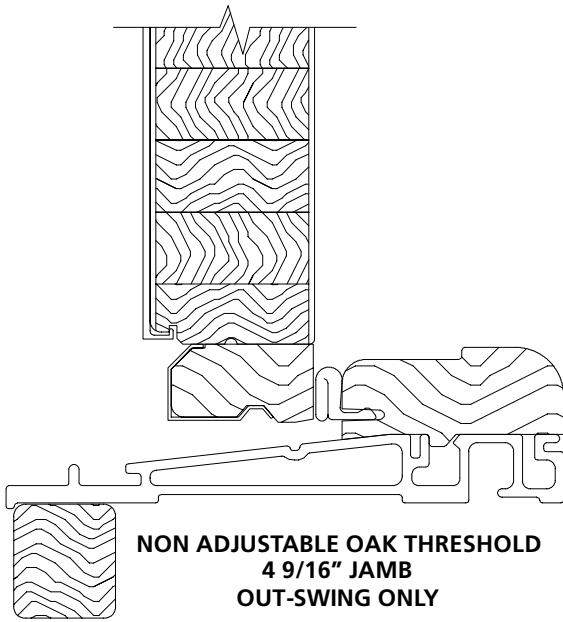
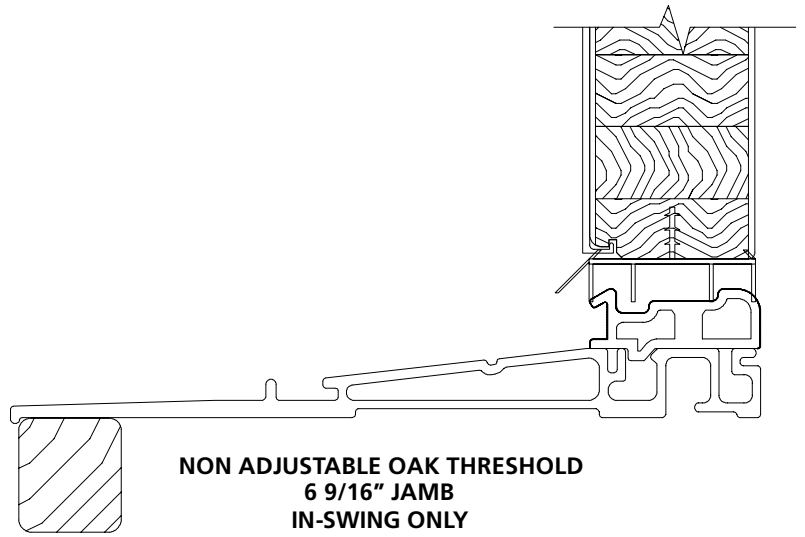
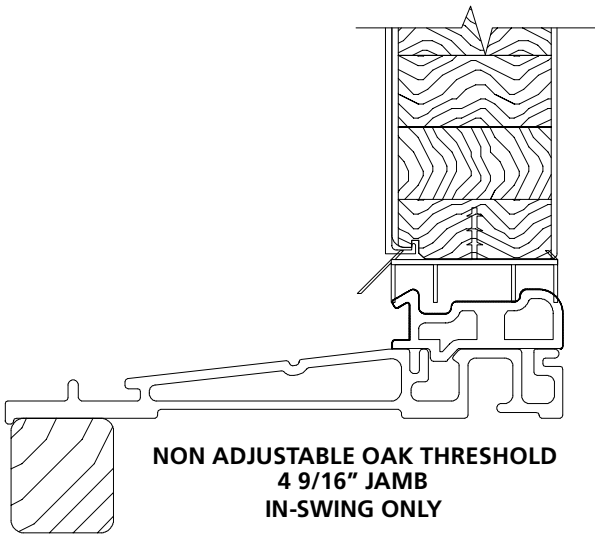

SCALE: 6" = 1'

HANDICAP SILL OPTIONS

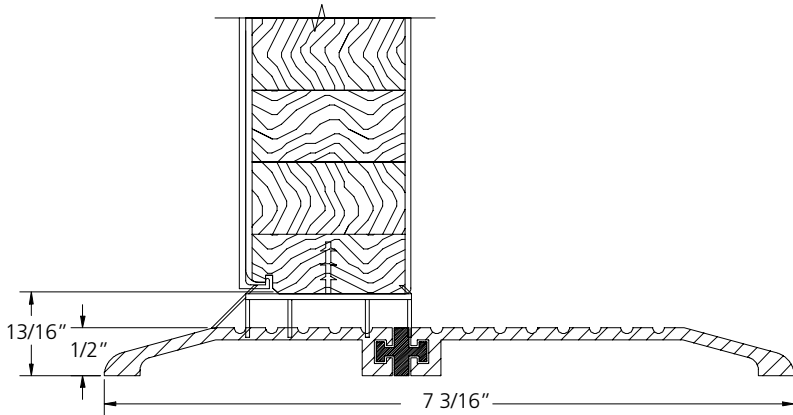

**HANDICAP SILL
OUT-SWING**

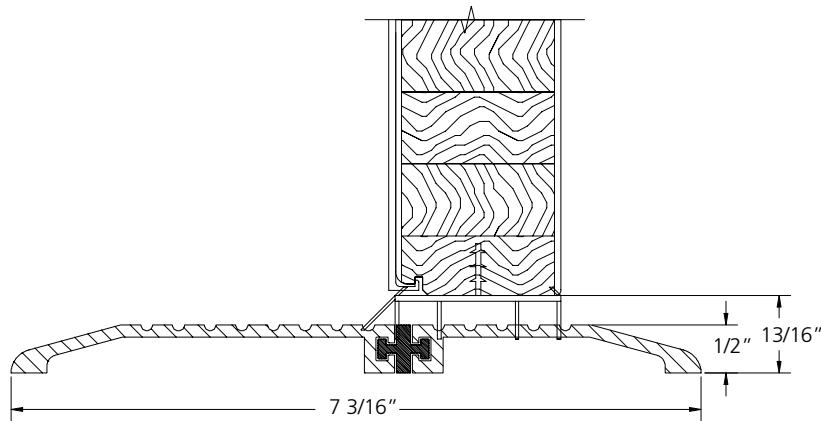

**HANDICAP SILL
IN-SWING**

Note: Handicapped sills are intended to meet the requirements of CABO/ANSI A117.1, Accessible and Usable Buildings and Facilities, paragraph 4.13.8. They feature an extruded, flexible vinyl thermal break to minimize heat transfer and the buildup of frost or condensation in cold climates. The use of the handicap sill does reduce the standard door height by 13/16".

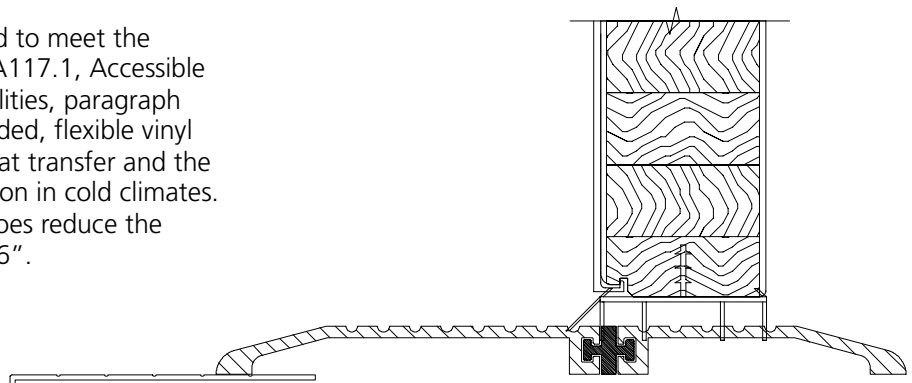

**HANDICAP SILL
IN-SWING**

**HANDICAP SILL WITH SILL EXPANDER
MAXIMUM PROJECTION IS 2"**

SCALE: 6" = 1'

SINGLE SWING IN-SWING

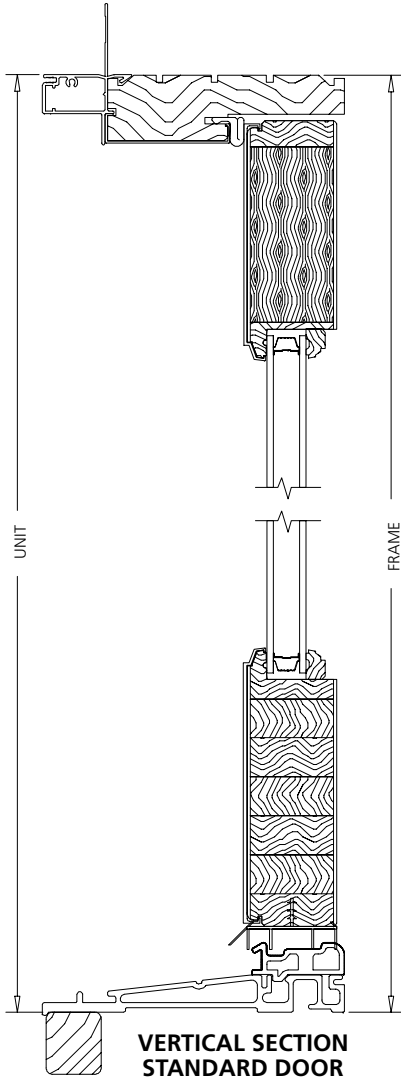

**VERTICAL SECTION
STANDARD DOOR**

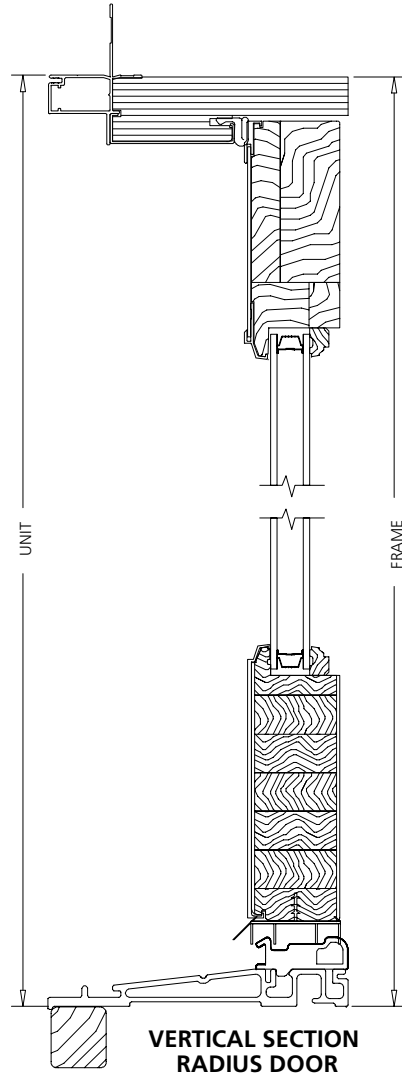

**VERTICAL SECTION
RADIUS DOOR**

Note: Bottom rail shown is for 6'-8" doors. Bottom rail is 3" taller for doors over 6'-8".

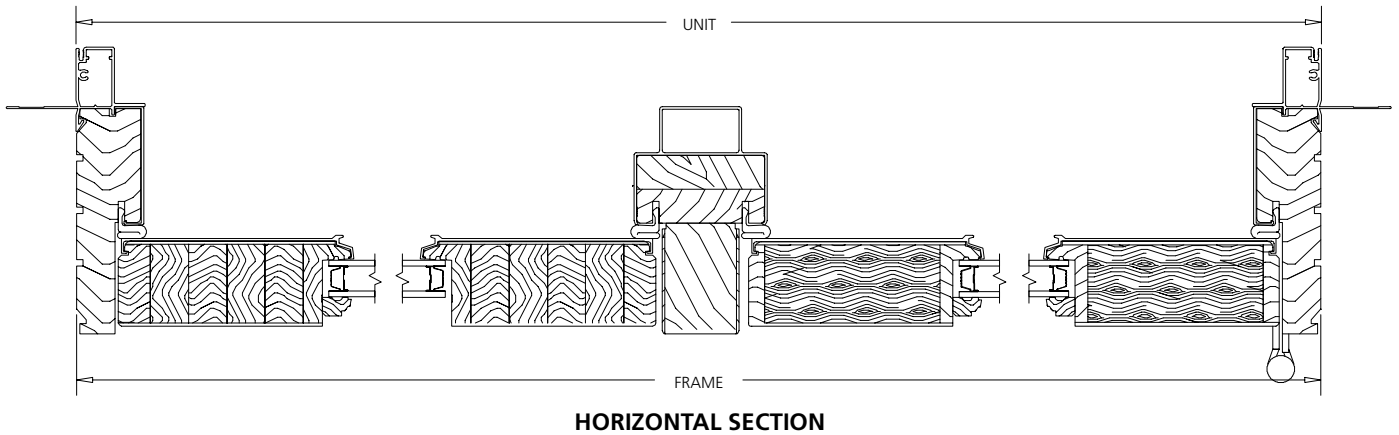

HORIZONTAL SECTION

SCALE: 3" = 1'

**SINGLE SWING IN-SWING
WITH 6-9/16" JAMB**

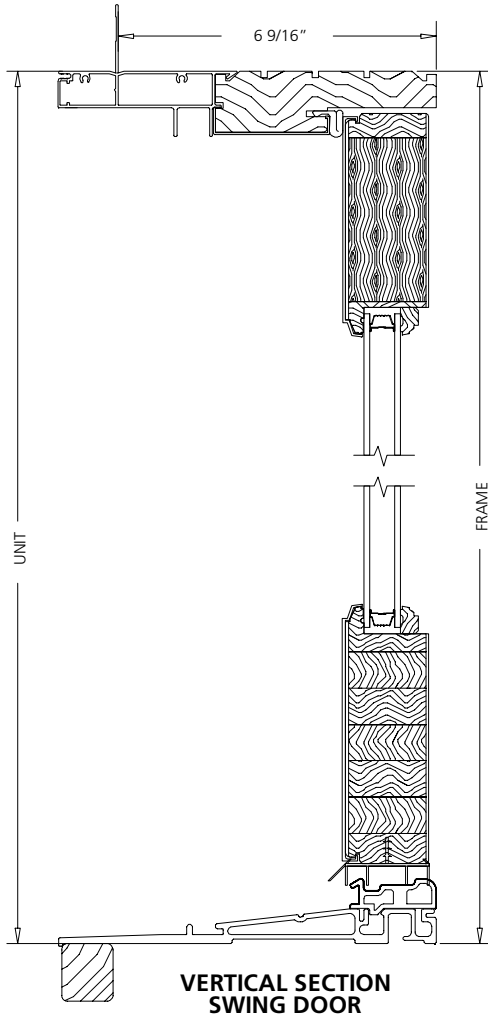

**VERTICAL SECTION
SWING DOOR**

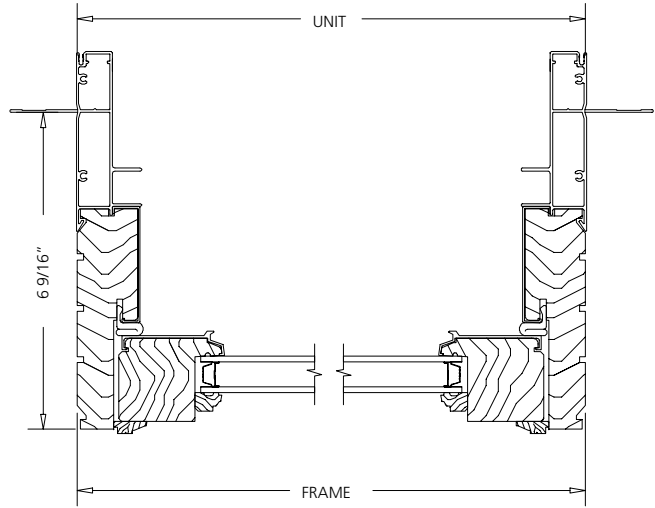

**HORIZONTAL SECTION
SWING DOOR SIDELIGHT**

Note: Bottom rail shown is for 6'-8" doors.
Bottom rail is 3" taller for doors over 6'-8".

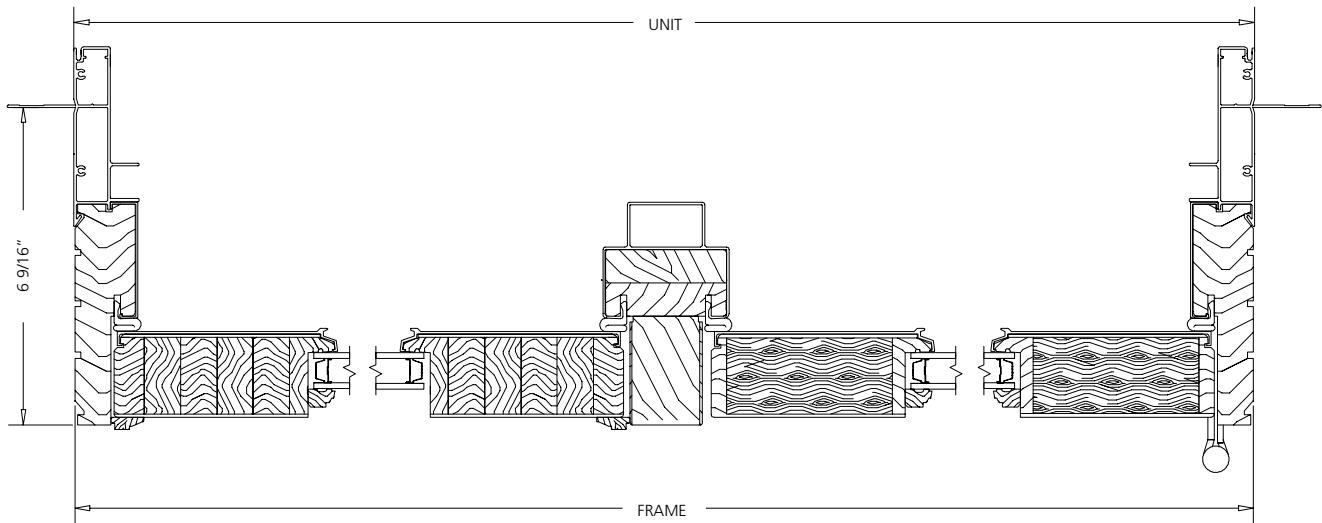

**HORIZONTAL SECTION
SWING DOOR**

SCALE: 3" = 1'

**SINGLE SWING IN-SWING
WITH APPLIED CLAD BRICKMOULD AND NOSING**

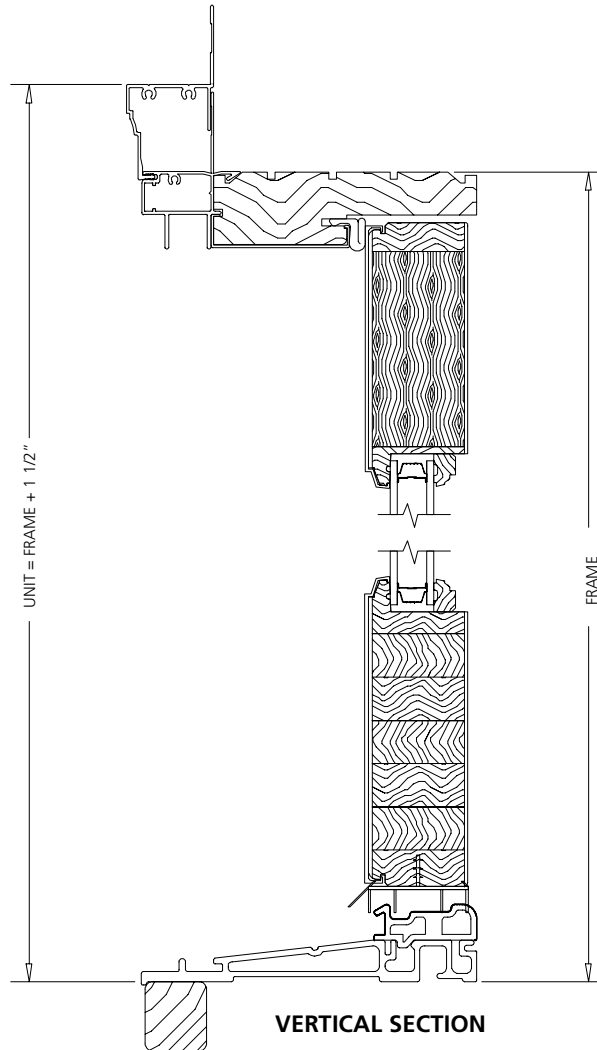

Note: Bottom rail shown is for 6'-8" doors. Bottom rail is 3" taller for doors over 6'-8".

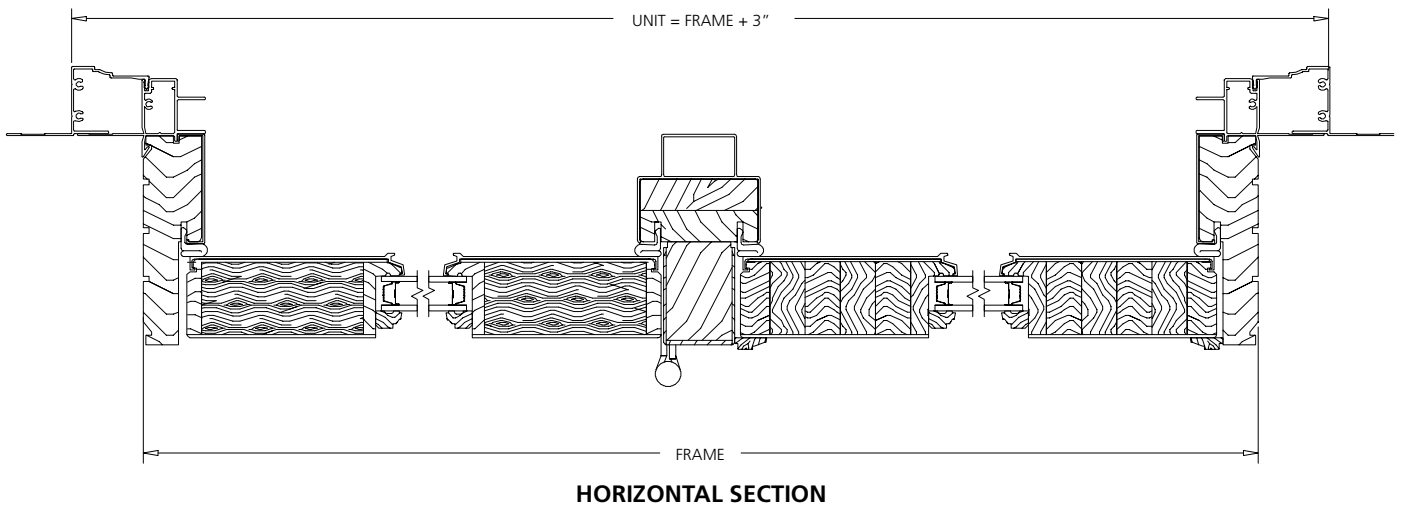

SCALE: 3" = 1'

SINGLE SWING IN-SWING

WITH CLAD PINE BOTTOM PANEL

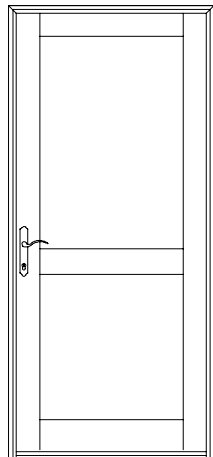
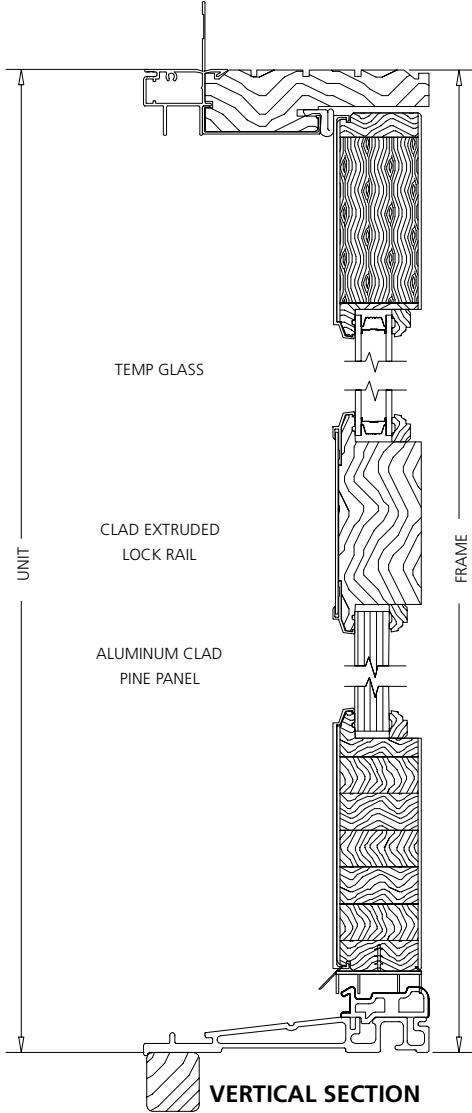

SWING DOOR ELEVATION

WITH GLASS BOTTOM PANEL

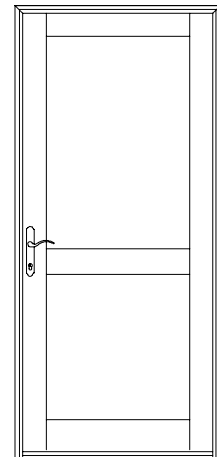
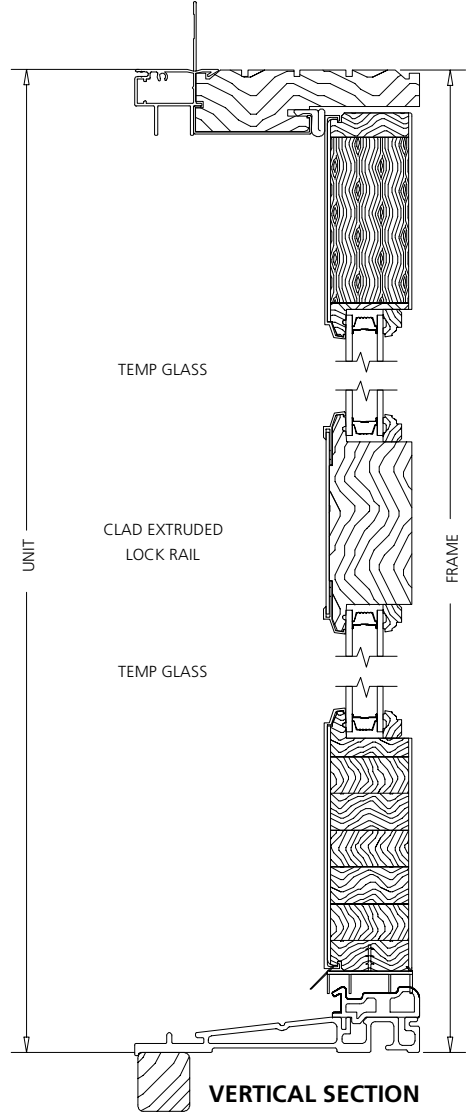

SWING DOOR ELEVATION

Note: Bottom rail shown is for 6'-8" doors. Bottom rail is 3" taller for doors over 6'-8".

SCALE: 3" = 1'

**SINGLE SWING IN-SWING
3-PANEL**

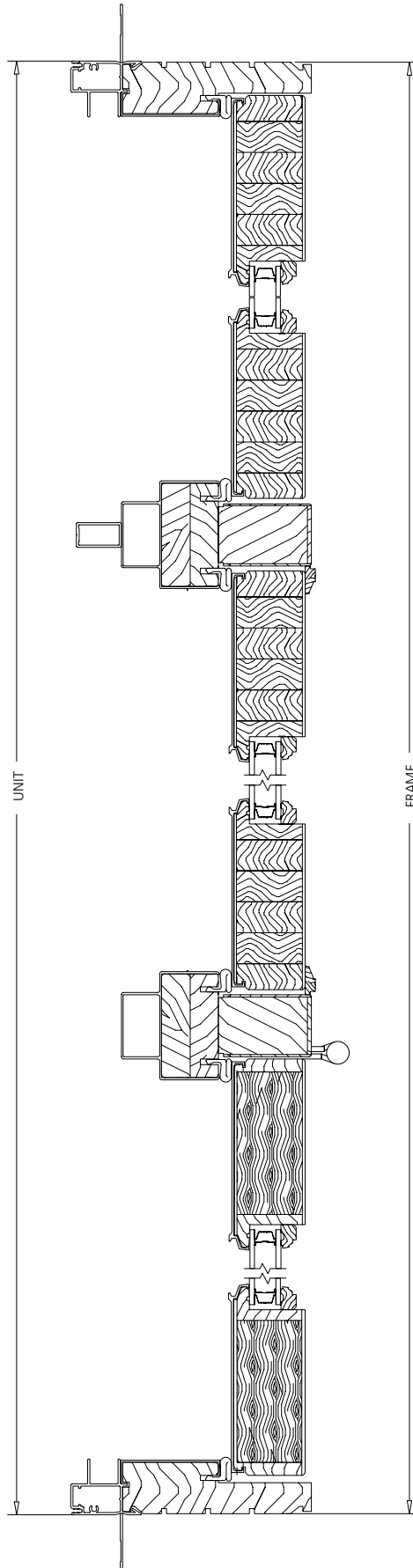

HORIZONTAL SECTION

SCALE: 3" = 1'

SINGLE SWING OUT-SWING

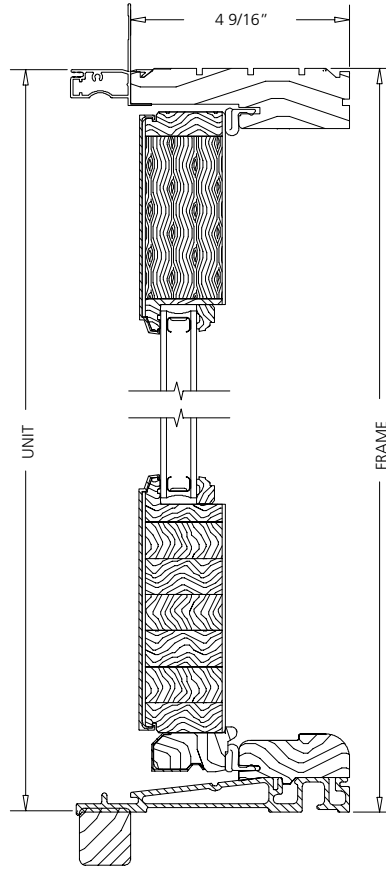

VERTICAL SECTION

Note: Bottom rail shown is for 6'-8" doors. Bottom rail is 3" taller for doors over 6'-8".

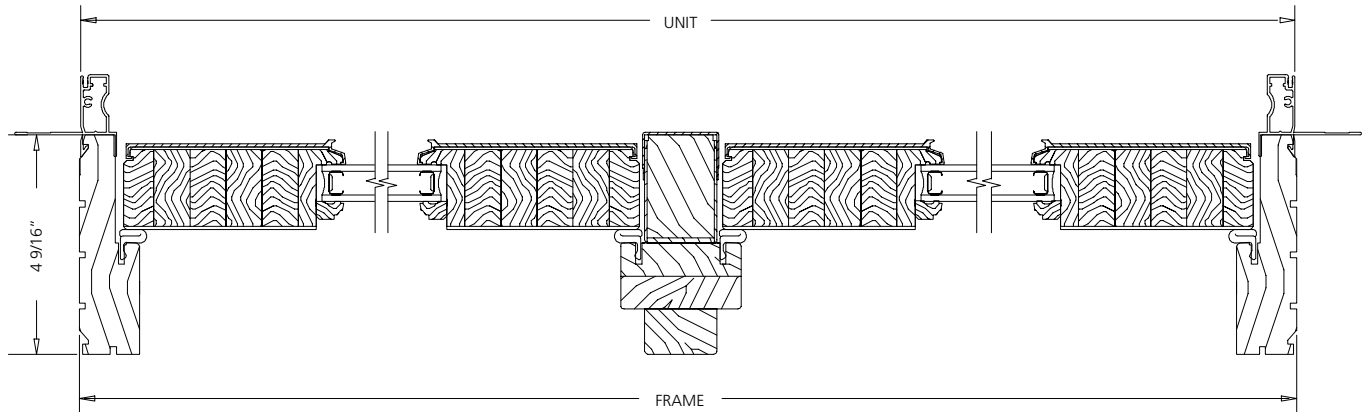

HORIZONTAL SECTION

SCALE: 3" = 1'

**SINGLE SWING OUT-SWING
WITH 6-9/16" EXTENSION JAMB**

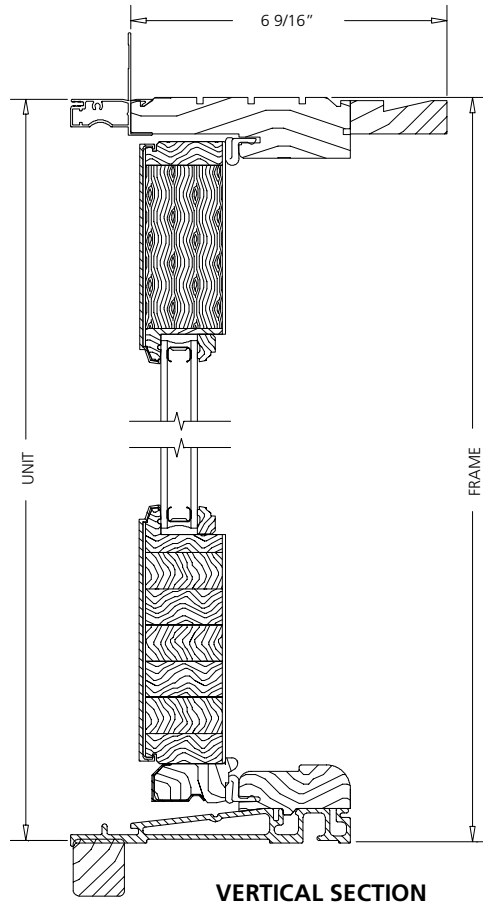

VERTICAL SECTION

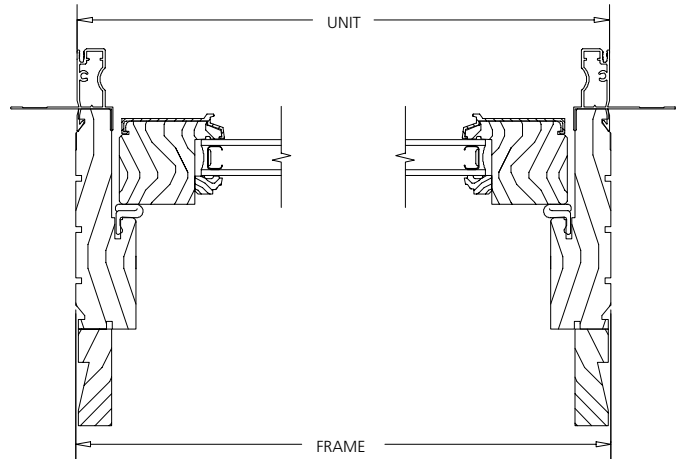

**HORIZONTAL SECTION
SIDELIGHT**

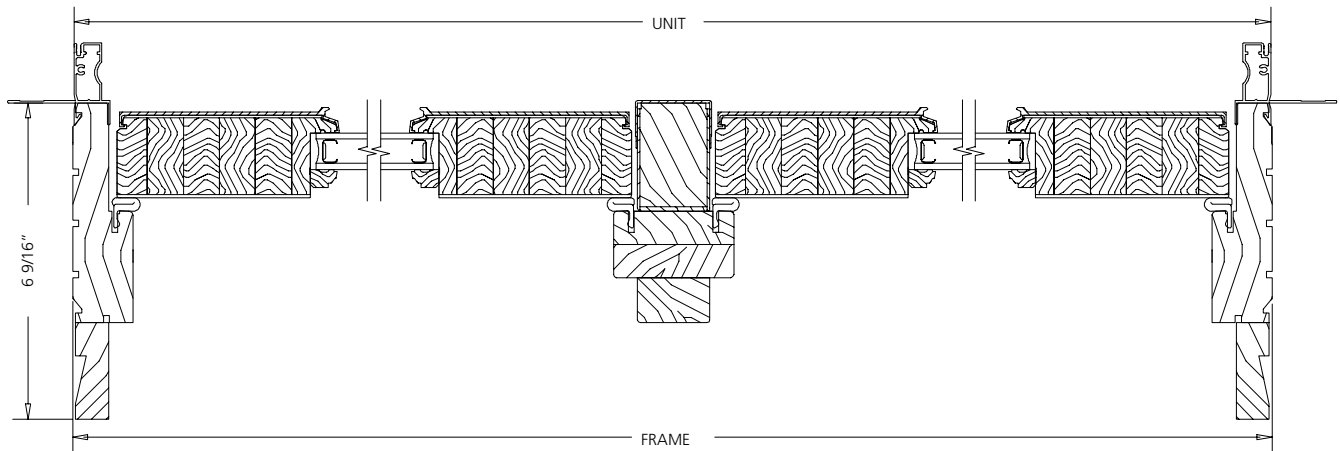

HORIZONTAL SECTION

Note: Bottom rail shown is for 6'-8" doors. Bottom rail is 3" taller for doors over 6'-8".

SCALE: 3" = 1'

**SINGLE SWING OUT-SWING
WITH APPLIED CLAD BRICKMOULD**

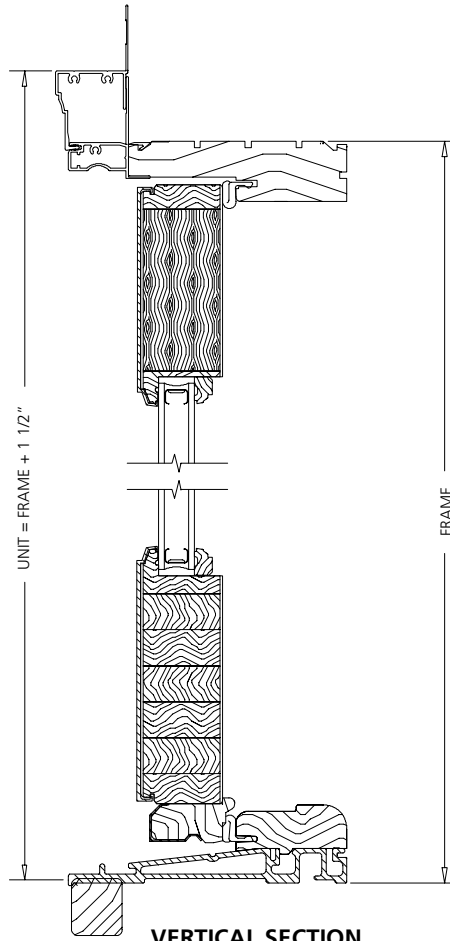

VERTICAL SECTION

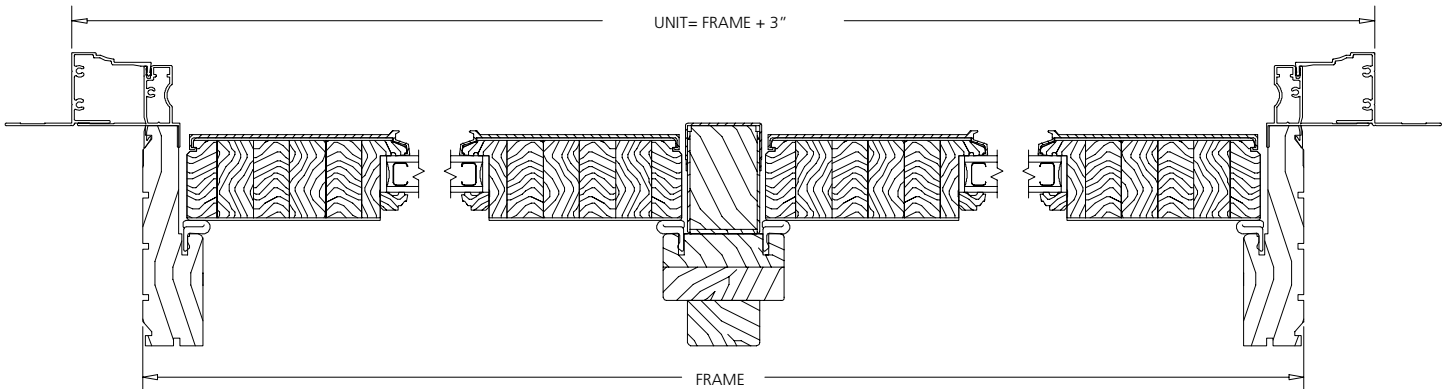

HORIZONTAL SECTION

Note: Bottom rail shown is for 6'-8" doors. Bottom rail is 3" taller for doors over 6'-8".

SCALE: 3" = 1'

SINGLE SWING OUT-SWING

WITH CLAD PINE BOTTOM PANEL

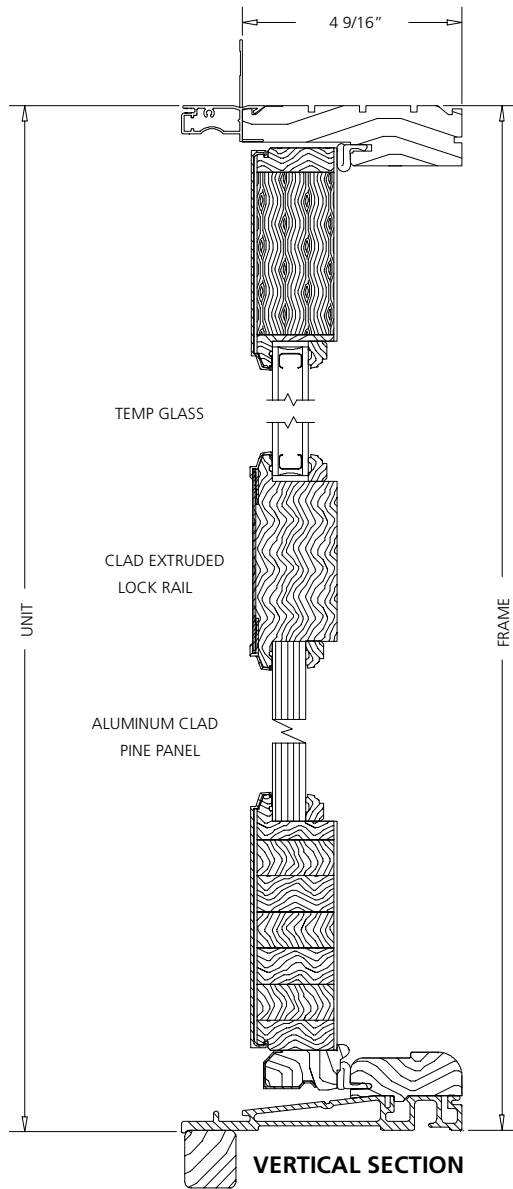

WITH GLASS BOTTOM PANEL

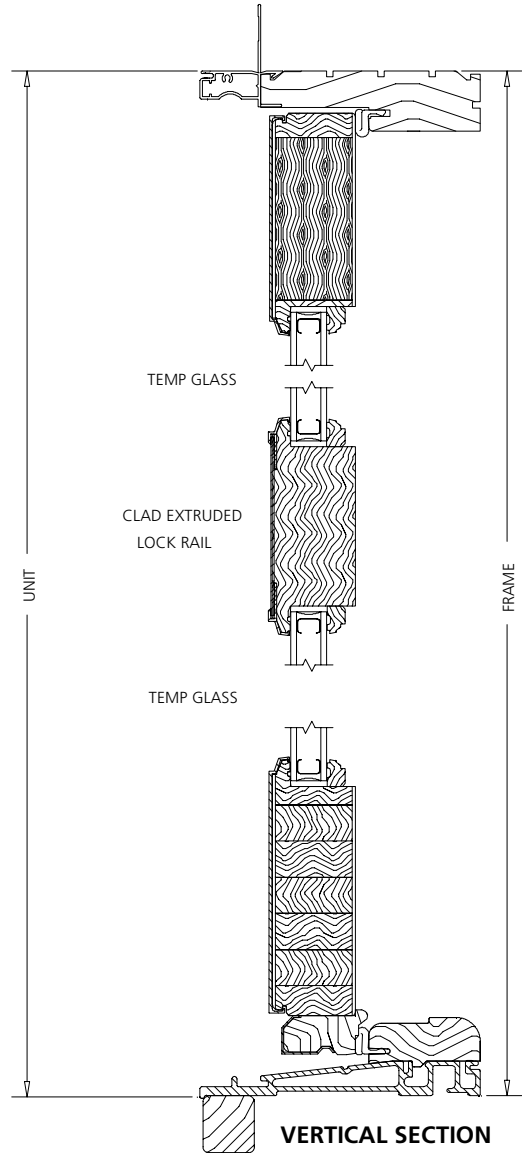

Note: Bottom rail shown is for 6'-8" doors. Bottom rail is 3" taller for doors over 6'-8".

SCALE: 3" = 1'

**SINGLE SWING OUT-SWING
3-PANEL**

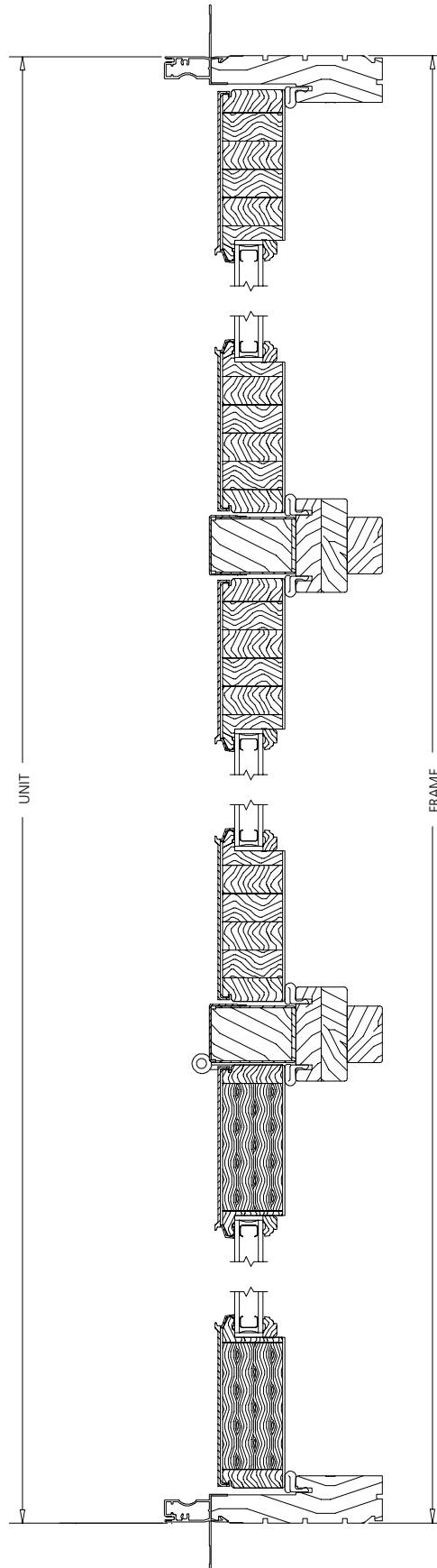

HORIZONTAL SECTION

SCALE: 3" = 1'

FRENCH IN-SWING

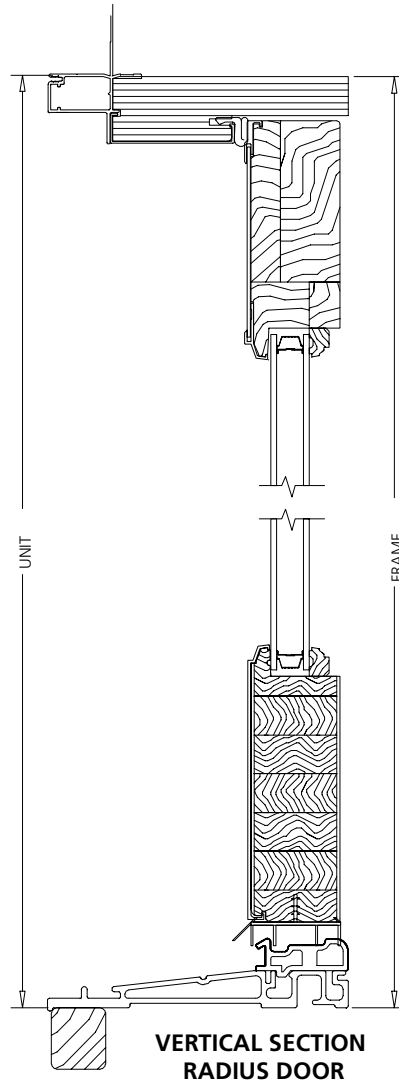
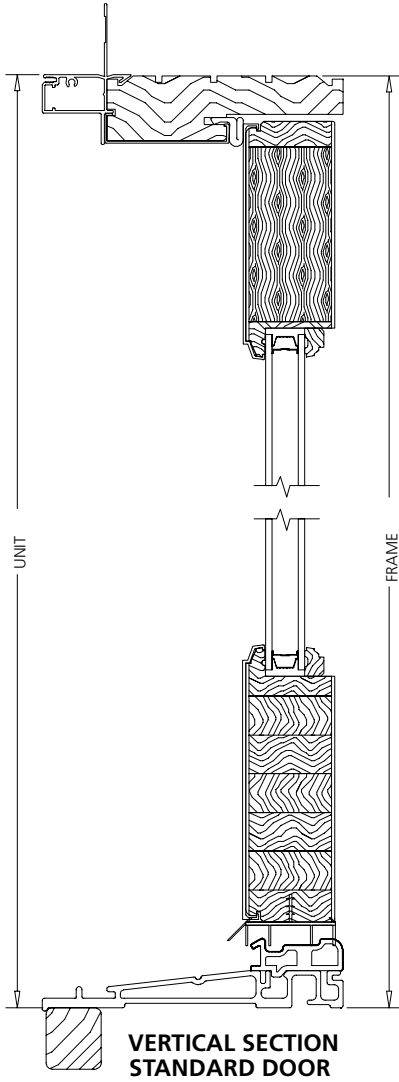

Note: Bottom rail shown is for 6'-8" doors. Bottom rail is 3" taller for doors over 6'-8".

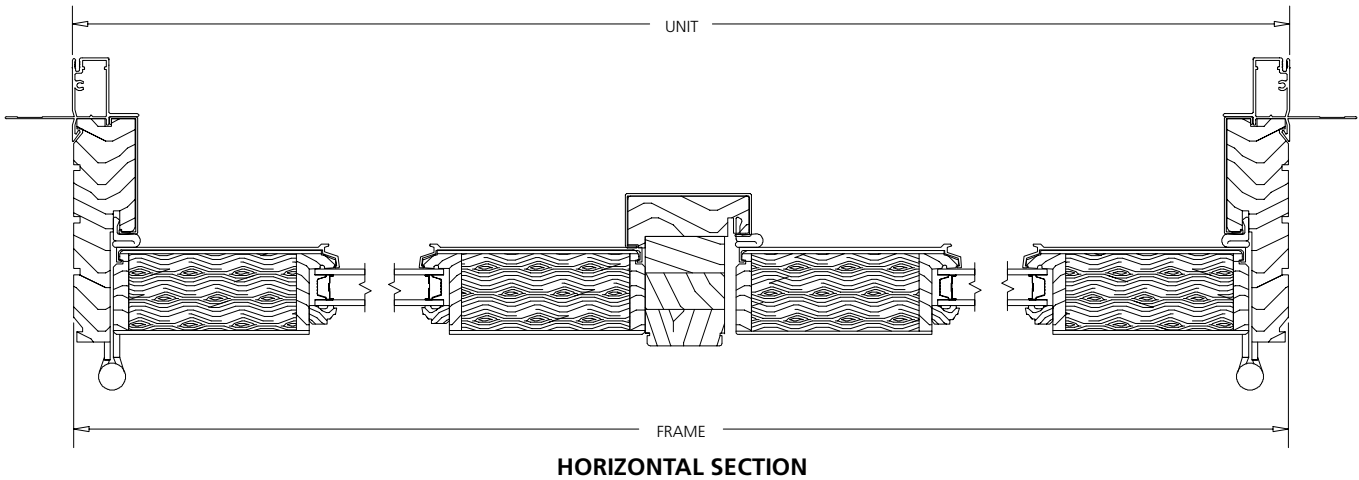

SCALE: 3" = 1'

**FRENCH IN-SWING
WITH SIDELIGHTS**

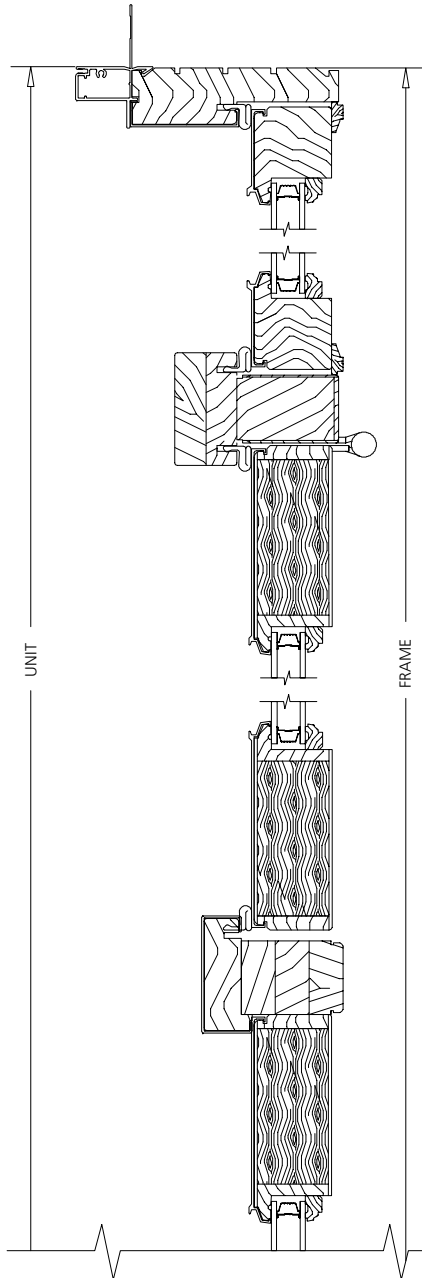

HORIZONTAL SECTION

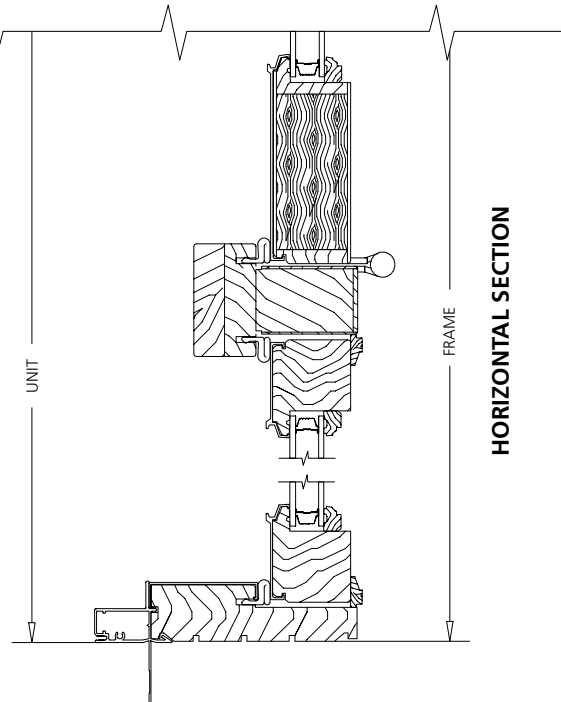

HORIZONTAL SECTION

Note: French In-swing door is shown with 2 1/8" stiles used in 1-0 and 1-6 sidelights. 2-0 sidelights have 3 3/16" stiles. Sidelights over 2-0 in width have 4 9/16" stiles.

SCALE: 3" = 1'

FRENCH OUT-SWING

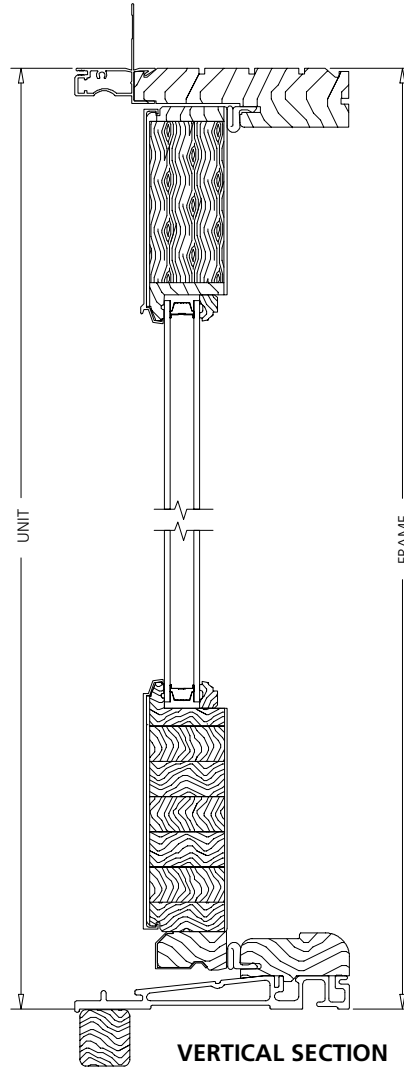

Note: Bottom rail shown is for 6'-8" doors. Bottom rail is 3" taller for doors over 6'-8".

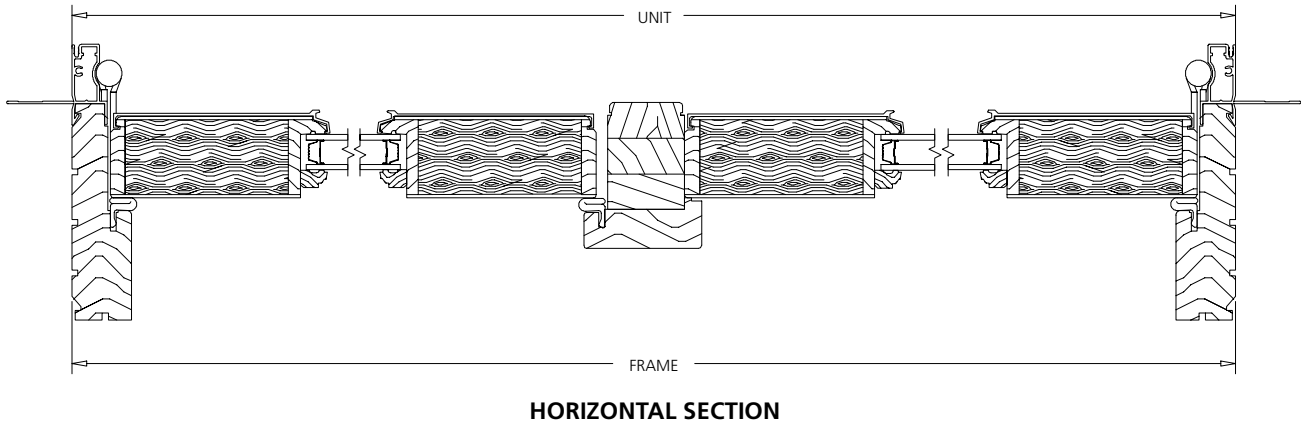

SCALE: 3" = 1'

**FRENCH OUT-SWING
WITH SIDELIGHTS**

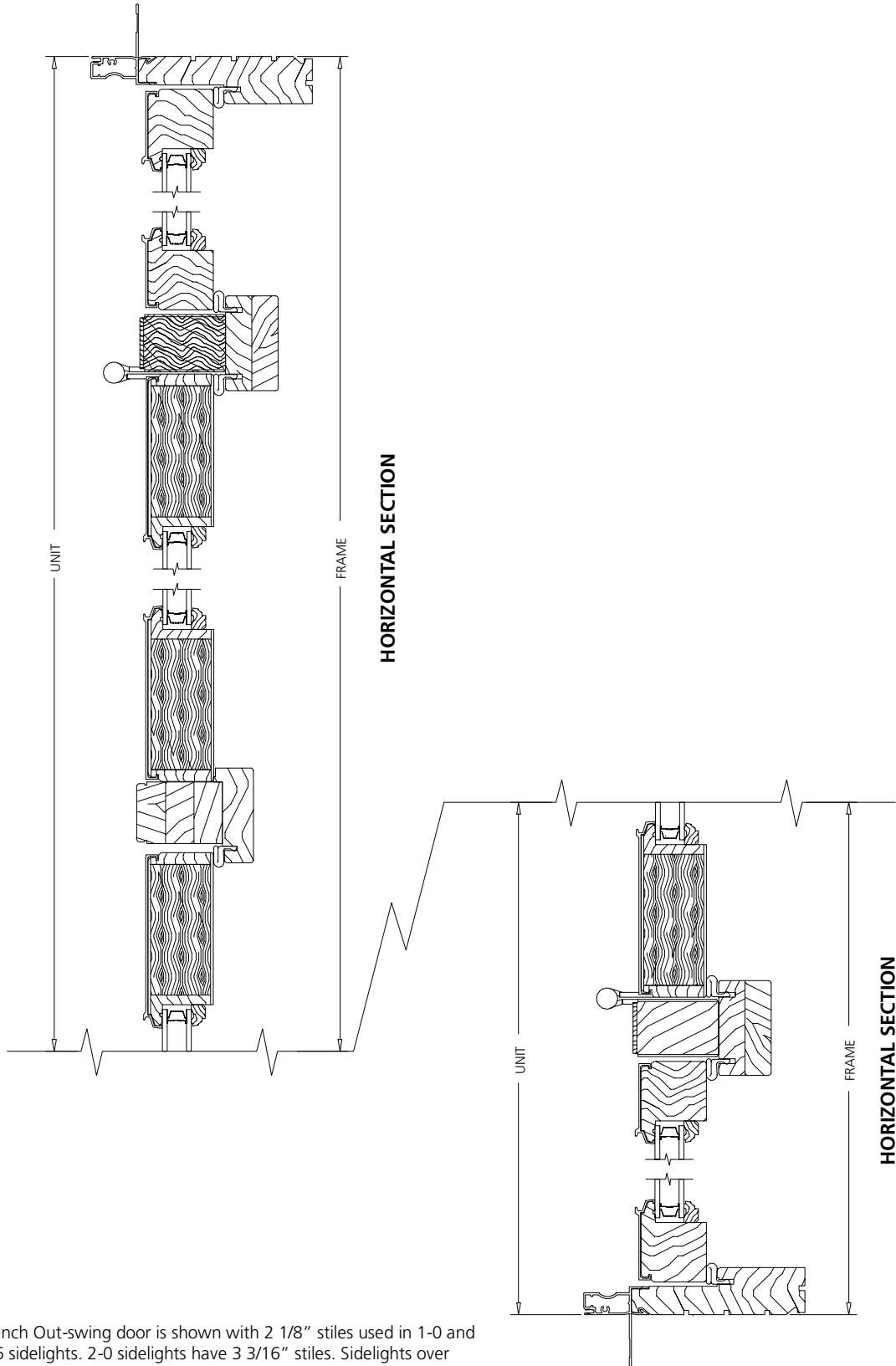

Note: French Out-swing door is shown with 2 1/8" stiles used in 1-0 and 1-6 sidelights. 2-0 sidelights have 3 3/16" stiles. Sidelights over 2-0 in width have 4 9/16" stiles.

SCALE: 3" = 1'

IN-SWING AND OUT-SWING TRANSOM MULL WITH 4-9/16" JAMB

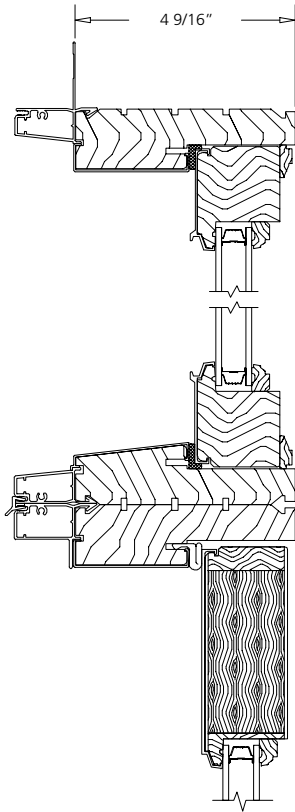

**VERTICAL SECTION
TRANSOM MULLED ABOVE
A CLAD IN-SWING
SINGLE AND FRENCH SWING DOOR**

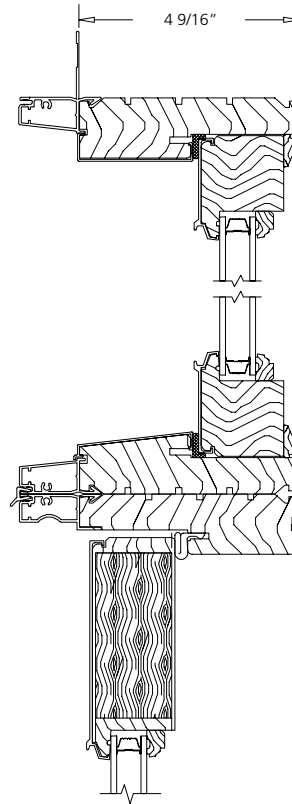

**VERTICAL SECTION
TRANSOM MULLED ABOVE
A CLAD OUT-SWING
SINGLE AND FRENCH SWING DOOR**

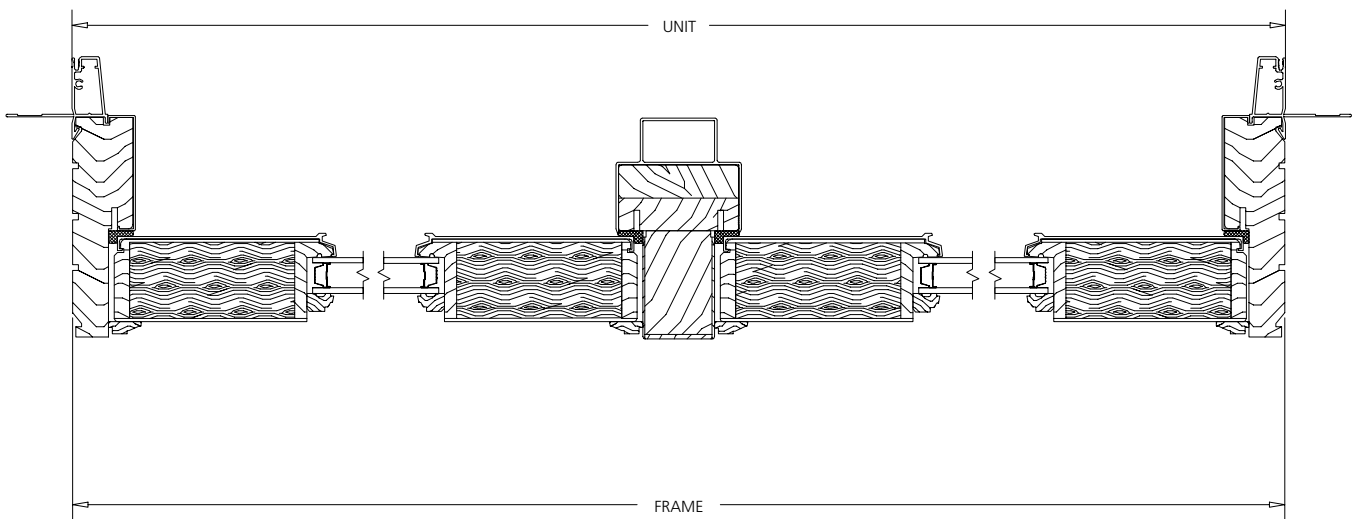

HORIZONTAL SECTION

SCALE: 3" = 1'

**IN-SWING AND OUT-SWING TRANSOM MULL
WITH 6-9/16" JAMB**

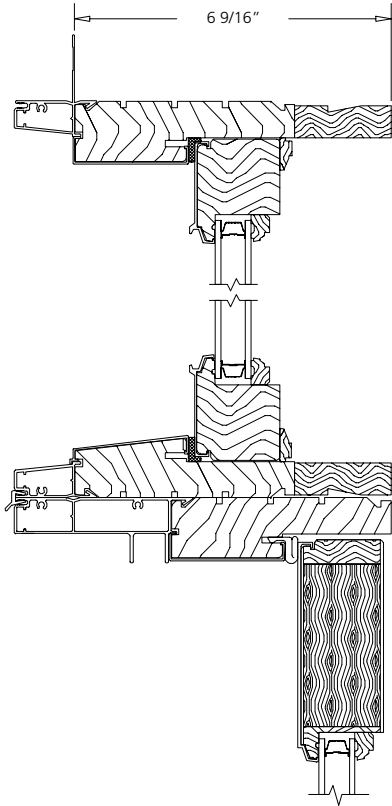

**VERTICAL SECTION
TRANSOM MULLED ABOVE
A CLAD IN-SWING
SINGLE AND FRENCH SWING DOOR**

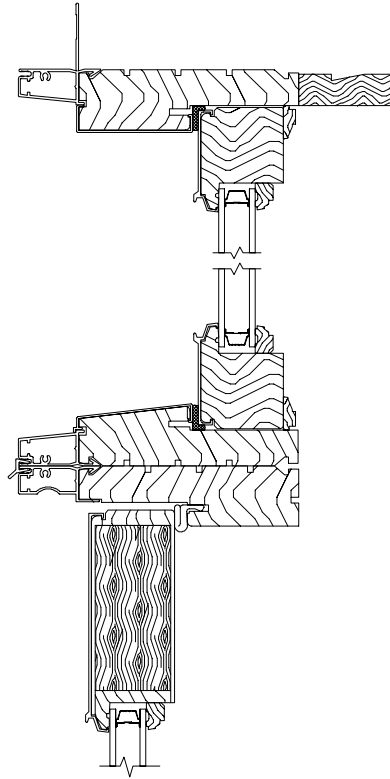

**VERTICAL SECTION
TRANSOM MULLED ABOVE
A CLAD OUT-SWING
SINGLE AND FRENCH SWING DOOR**

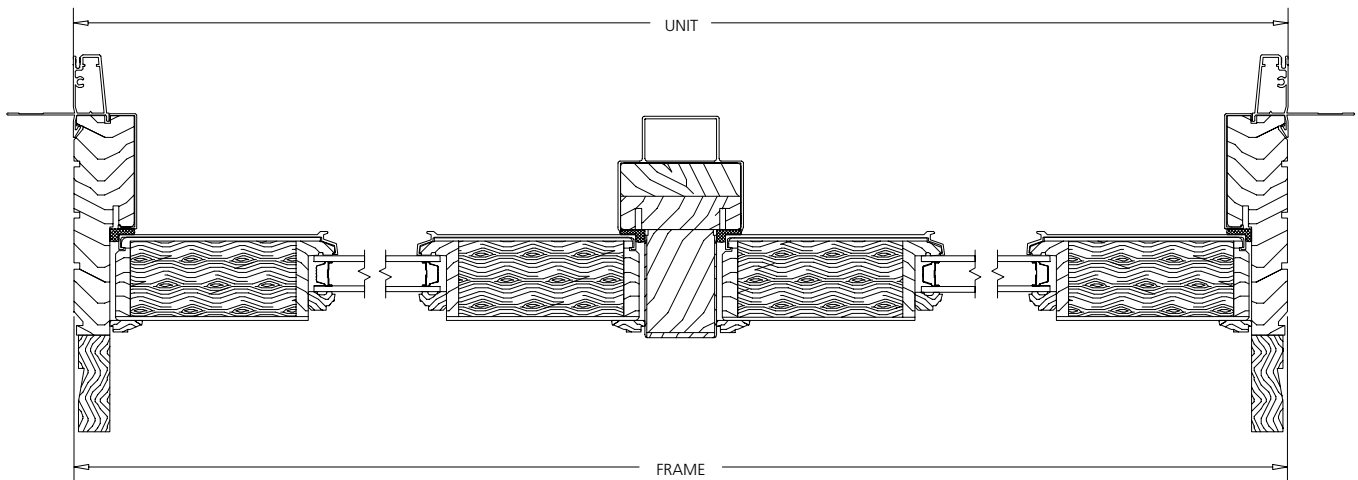

HORIZONTAL SECTION

SCALE: 3" = 1'

SWING SCREEN

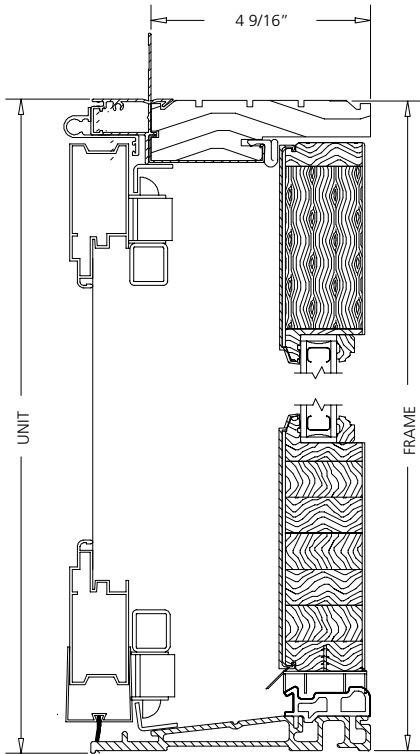

**VERTICAL SECTION
4 9/16" JAMB**

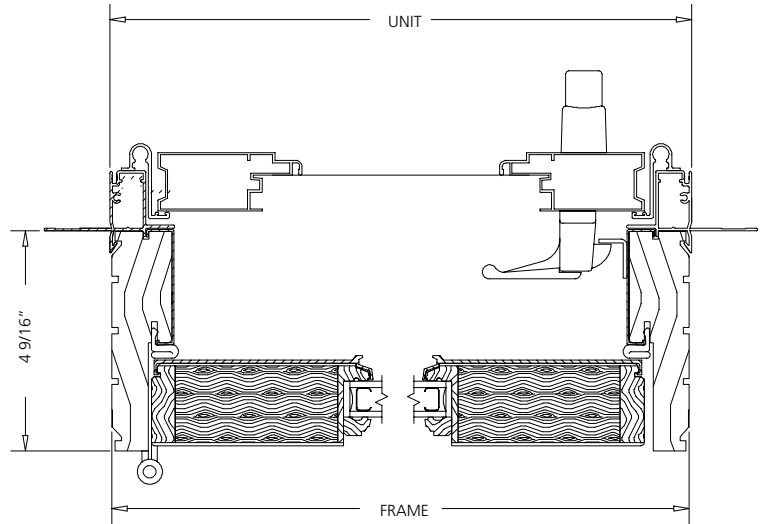

**HORIZONTAL SECTION
4 9/16" JAMB**

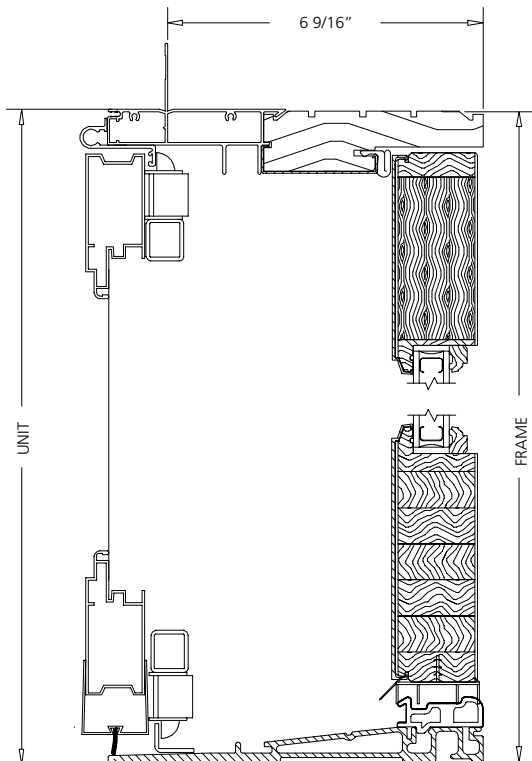

**VERTICAL SECTION
6 9/16" JAMB**

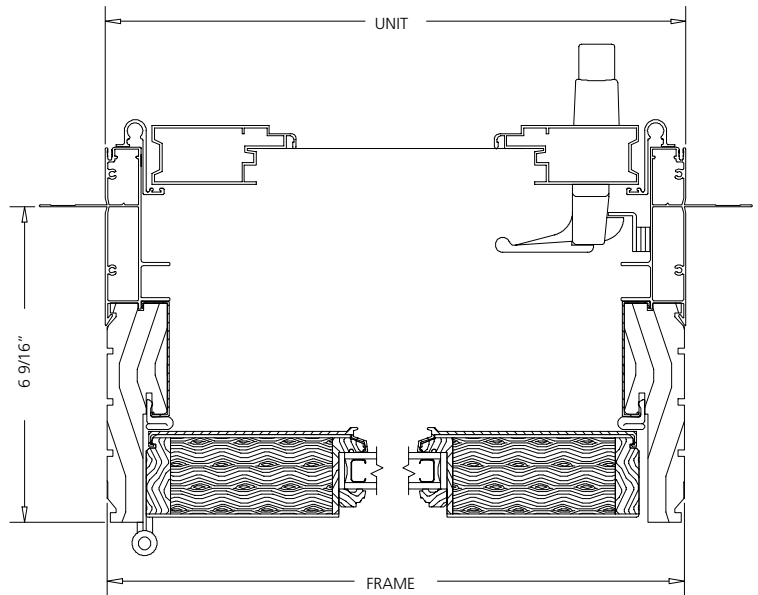

**HORIZONTAL SECTION
6 9/16" JAMB**

SCALE: 3" = 1'

**SWING SCREEN
WITH 6-9/16" JAMB**

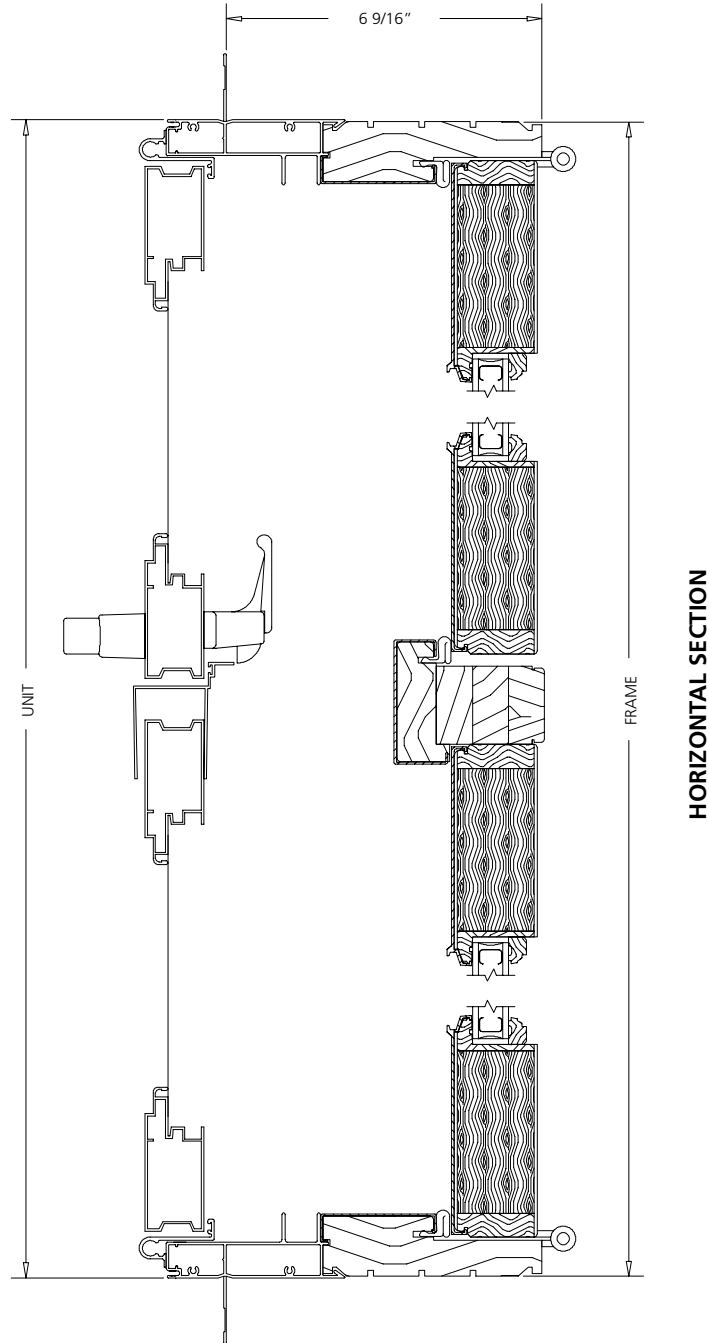

SCALE: 3" = 1'

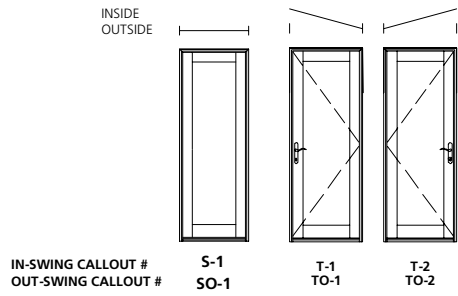

Doors pictured as viewed from exterior.

Top down view shows panels as In-Swing.

All extension is opposite panel swing.

OUT-SWING OPTION:
Numerical callout for Out-Swing doors does not change. Add "Out-Swing" to description and use TO callout.

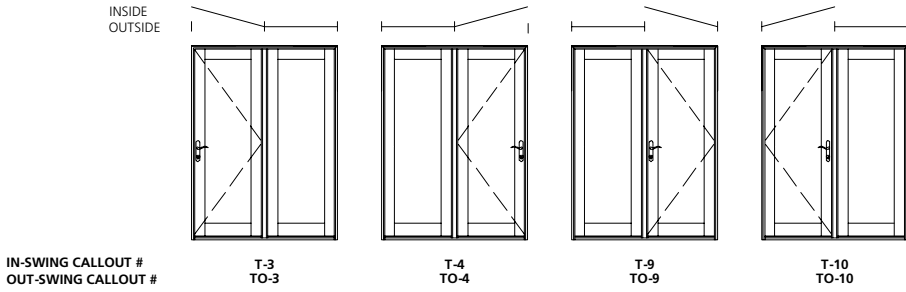

OUT-SWING OPTION:
Numerical callout for Out-Swing doors does not change. Add "Out-Swing" to description and use TO callout.

Top down view shows panels as In-Swing.

All extension is opposite panel swing.

Doors pictured as viewed from exterior.

INSIDE
OUTSIDE

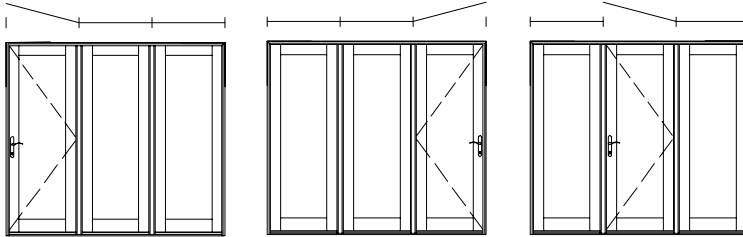

IN-SWING CALLOUT #
OUT-SWING CALLOUT #

T-5
TO-5

T-6
TO-6

T-7
TO-7

OUT-SWING OPTION:
Numerical callout for Out-Swing doors does not change. Add "Out-Swing" to description and use TO callout.

INSIDE
OUTSIDE

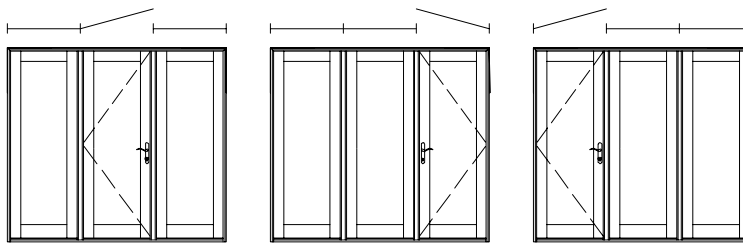

IN-SWING CALLOUT #
OUT-SWING CALLOUT #

T-8
TO-8

T-11
TO-11

T-12
TO-12

Top down view shows panels as In-Swing.

All extension is opposite panel swing.

Doors pictured as viewed from exterior.

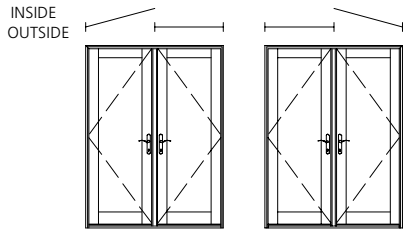

IN-SWING CALLOUT #	F-1	F-2
OUT-SWING CALLOUT #	FO-1	FO-2

OUT-SWING OPTION:
 Numerical callout for Out-Swing doors does not change. Add "Out-Swing" to description and use FO callout.

Top down view shows panels as In-Swing.

All extension is opposite panel swing.

Doors pictured as viewed from exterior.

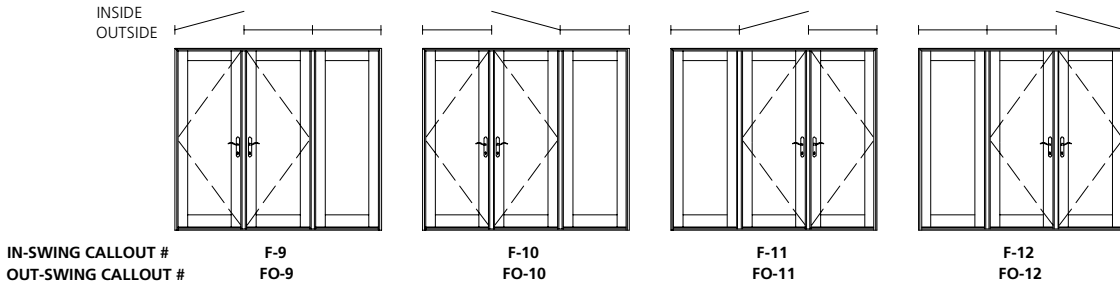

Doors pictured as viewed from exterior.

OUT-SWING OPTION:
 Numerical callout for Out-Swing doors does not change. Add "Out-Swing" to description and use FO callout.

Top down view shows panels as In-Swing.

All extension is opposite panel swing.

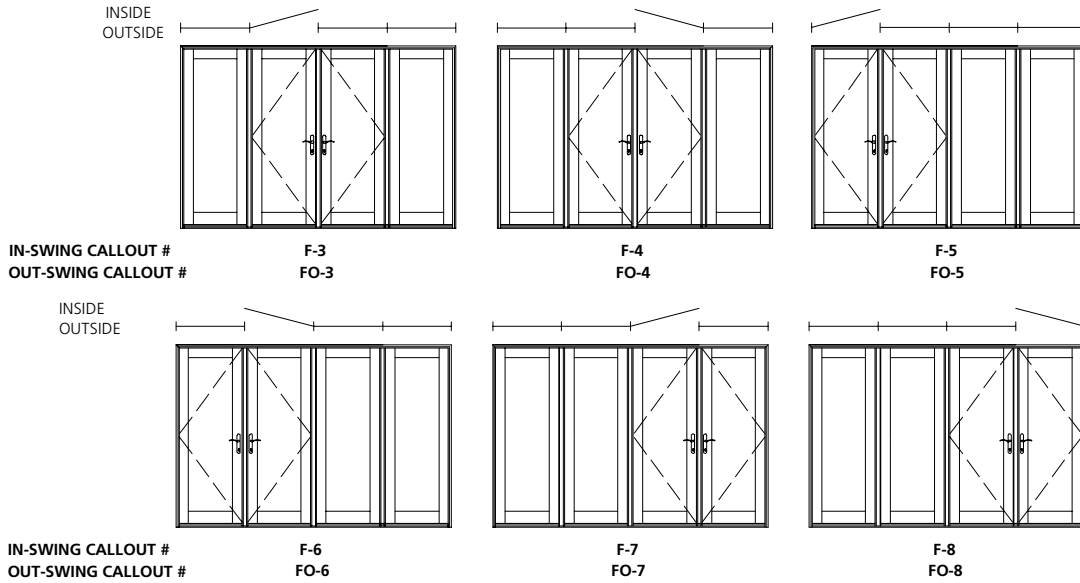

Doors pictured as viewed from exterior.

OUT-SWING OPTION:
Numerical callout for Out-Swing doors does not change. Add "Out-Swing" to description and use FO callout.

Top down view shows panels as In-Swing.

All extension is opposite panel swing.

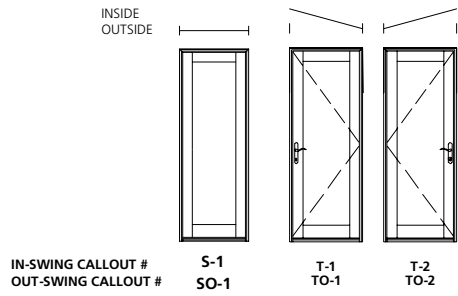

Doors pictured as viewed from exterior.

Top down view shows panels as In-Swing.

All extension is opposite panel swing.

OUT-SWING OPTION:
 Numerical callout for Out-Swing doors does not change. Add "Out-Swing" to description and use TO callout.

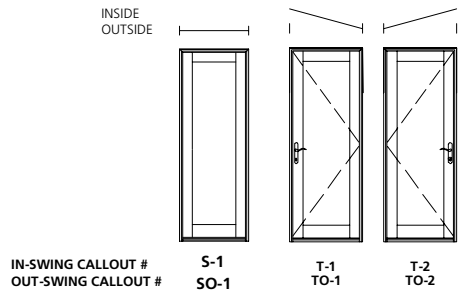

Doors pictured as viewed from exterior.

Top down view shows panels as In-Swing.

All extension is opposite panel swing.

OUT-SWING OPTION:
 Numerical callout for Out-Swing doors does not change. Add "Out-Swing" to description and use TO callout.

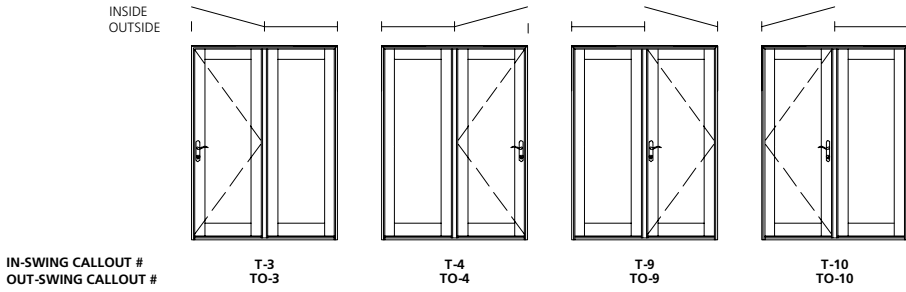

OUT-SWING OPTION:
Numerical callout for Out-Swing doors does not change. Add "Out-Swing" to description and use TO callout.

Top down view shows panels as In-Swing.

All extension is opposite panel swing.

Doors pictured as viewed from exterior.

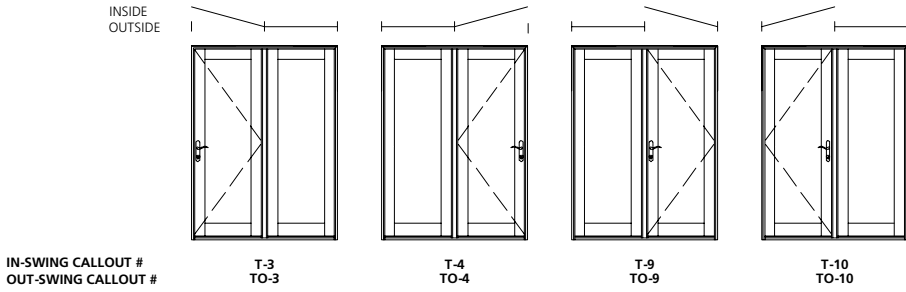

OUT-SWING OPTION:
Numerical callout for Out-Swing doors does not change. Add "Out-Swing" to description and use TO callout.

Top down view shows panels as In-Swing.

All extension is opposite panel swing.

Doors pictured as viewed from exterior.

INSIDE
OUTSIDE

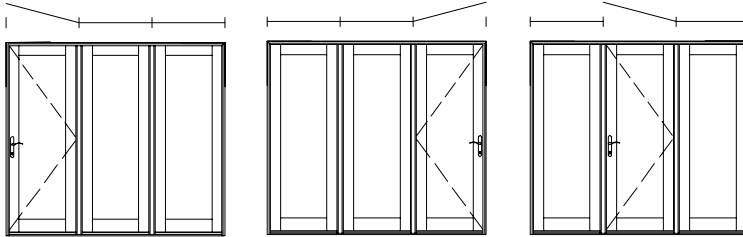

IN-SWING CALLOUT #
OUT-SWING CALLOUT #

T-5
TO-5

T-6
TO-6

T-7
TO-7

OUT-SWING OPTION:
Numerical callout for Out-Swing doors does not change. Add "Out-Swing" to description and use TO callout.

INSIDE
OUTSIDE

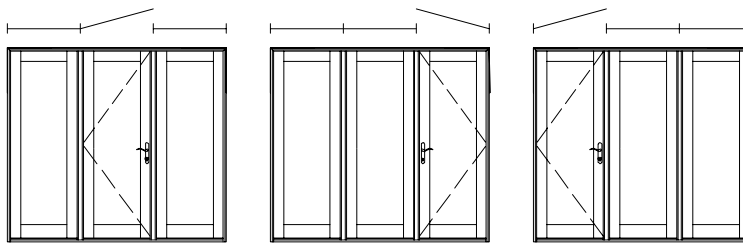

IN-SWING CALLOUT #
OUT-SWING CALLOUT #

T-8
TO-8

T-11
TO-11

T-12
TO-12

Top down view shows panels as In-Swing.

All extension is opposite panel swing.

Doors pictured as viewed from exterior.

INSIDE
OUTSIDE

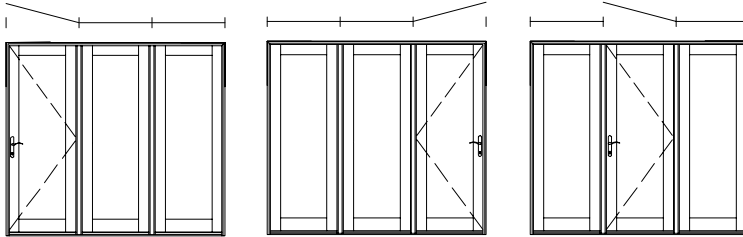

IN-SWING CALLOUT #
OUT-SWING CALLOUT #

T-5
TO-5

T-6
TO-6

T-7
TO-7

OUT-SWING OPTION:
Numerical callout for Out-Swing doors does not change. Add "Out-Swing" to description and use TO callout.

INSIDE
OUTSIDE

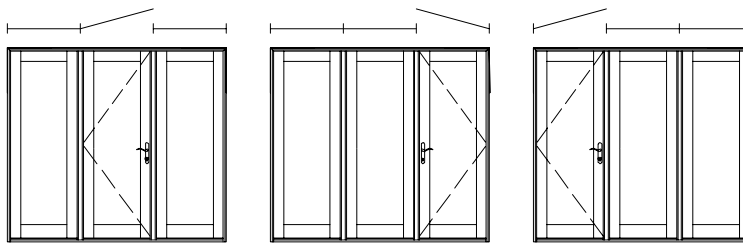

IN-SWING CALLOUT #
OUT-SWING CALLOUT #

T-8
TO-8

T-11
TO-11

T-12
TO-12

Top down view shows panels as In-Swing.

All extension is opposite panel swing.

Doors pictured as viewed from exterior.

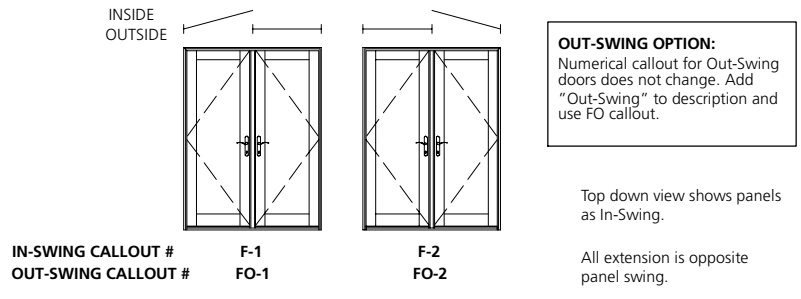

OUT-SWING OPTION:
 Numerical callout for Out-Swing doors does not change. Add "Out-Swing" to description and use FO callout.

Top down view shows panels as In-Swing.

All extension is opposite panel swing.

Doors pictured as viewed from exterior.

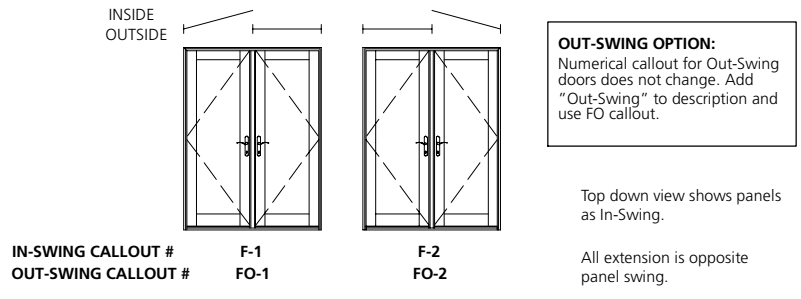

OUT-SWING OPTION:
 Numerical callout for Out-Swing doors does not change. Add "Out-Swing" to description and use FO callout.

Top down view shows panels as In-Swing.

All extension is opposite panel swing.

Doors pictured as viewed from exterior.

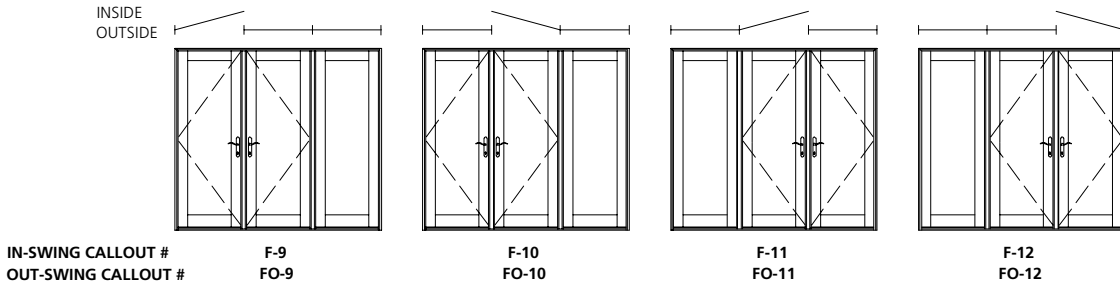

Doors pictured as viewed from exterior.

OUT-SWING OPTION:
 Numerical callout for Out-Swing doors does not change. Add "Out-Swing" to description and use FO callout.

Top down view shows panels as In-Swing.

All extension is opposite panel swing.

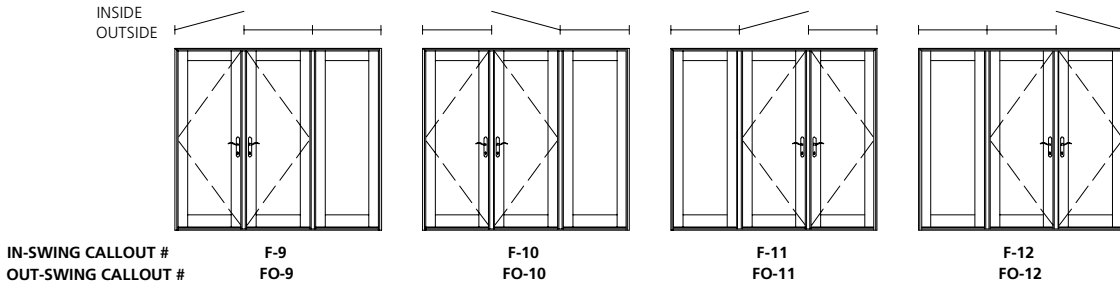

Doors pictured as viewed from exterior.

OUT-SWING OPTION:
 Numerical callout for Out-Swing doors does not change. Add "Out-Swing" to description and use FO callout.

Top down view shows panels as In-Swing.

All extension is opposite panel swing.

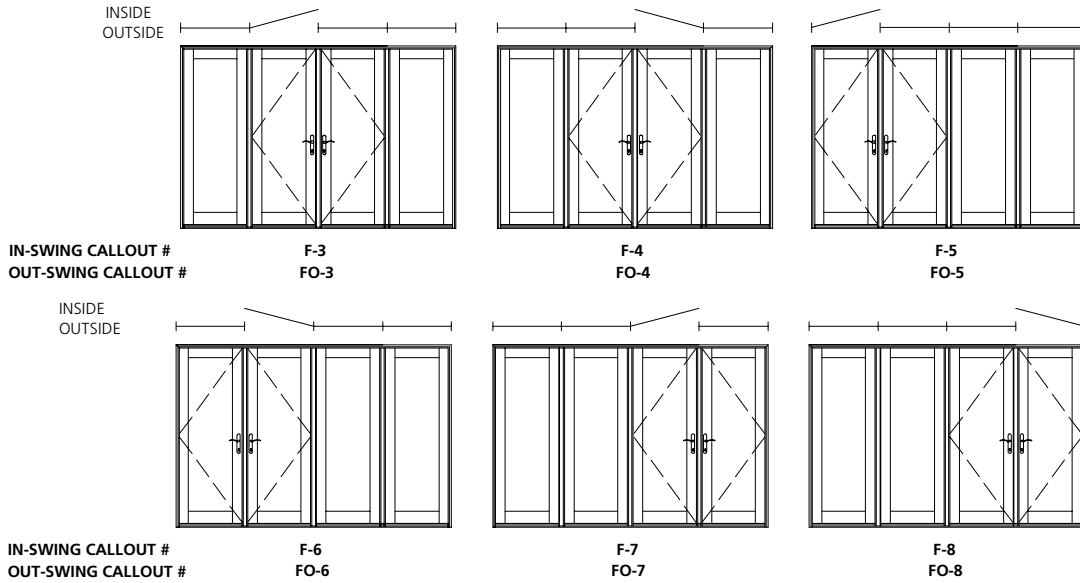

Doors pictured as viewed from exterior.

OUT-SWING OPTION:
 Numerical callout for Out-Swing doors does not change. Add "Out-Swing" to description and use FO callout.

Top down view shows panels as In-Swing.

All extension is opposite panel swing.

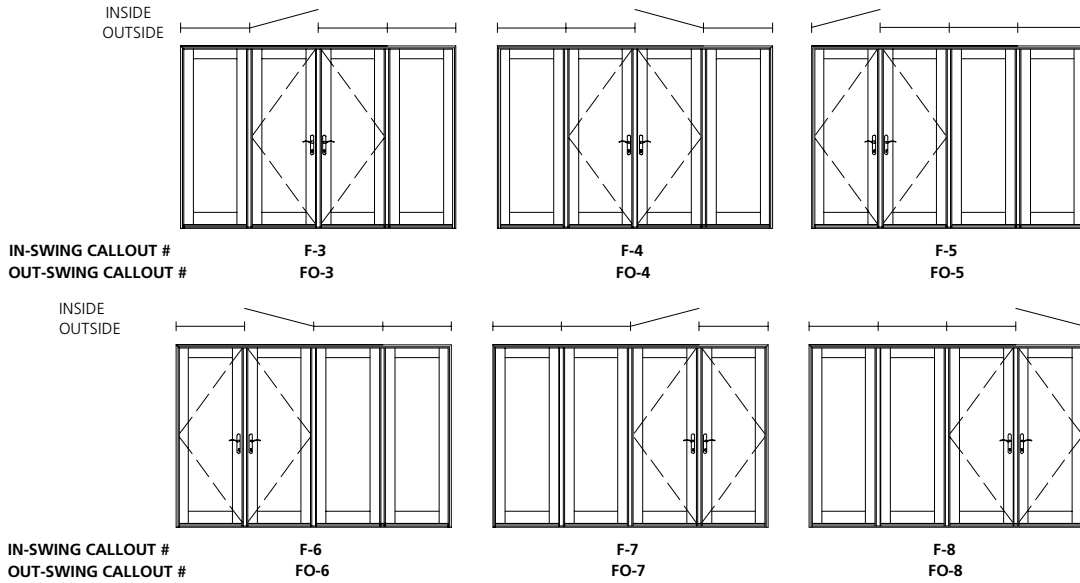

Doors pictured as viewed from exterior.

OUT-SWING OPTION:
 Numerical callout for Out-Swing doors does not change. Add "Out-Swing" to description and use FO callout.

Top down view shows panels as In-Swing.

All extension is opposite panel swing.