

---

**TABLE OF CONTENTS**

---

Specifications .....	16-2
Quick Spec Guide .....	16-4
Elevations: 1/4" Scale .....	16-6
Swinging Door Units .....	16-8
French Units .....	16-11
Single Door with Single Sidelite .....	16-13
Single Door with Two Sidelites .....	16-14
French Door with Two Sidelites .....	16-15
Transom Units .....	16-19
Sector Top Doors .....	16-24
French Sector Top Doors .....	16-26
French Sector Top Doors with Two Sidelites .....	16-28
Sector Top Transom Units .....	16-32
Glazing Options .....	16-33
Trim Options .....	16-36
Rail, Panel & Sill Options .....	16-37
Mullion Details .....	16-41
Grille & SDL Patterns .....	16-42
Clear Opening and Daylight Specifications .....	16-43
Unit Sizing, Rough Openings & Masonry Openings .....	16-48
Section Details: 3" Scale .....	16-49

**PRODUCT SPECIFICATIONS****EXTERIOR FINISH**

Exterior aluminum surfaces are finished with a fluoropolymer (70% Kynar 500®) multi-coat finish system to meet the performance standards required by AAMA specification #2605. Standard colors include Brilliant White, Chestnut Bronze, Desert Sand, French Vanilla, Hartford Green, Mesa Red, Black Licorice, Heirloom White, Hunter Green, Redwood, Sage Brown, and Smoke. Options include 27 Luxury Colors, Custom Color Matching and Clear Satin Anodized finish. Three copper finishes are available on door panels.

**AURALAST® WOOD**

AuraLast® wood is fundamentally different from wood treated in traditional millwork preservation processes in that it uses a proprietary vacuum/pressure process to provide protection throughout the wood parts used to make windows and doors. AuraLast® wood is distinguished from wood using traditional preservation methods by its unique ability to achieve greater penetration of the active ingredients into the wood parts, with a minimum treatment penetration of 92%.

**INTERIOR FINISH**

Interior surfaces are unfinished clear pine ready for on-site finishing. Optional prefinished pine interiors include four acrylic colors (Moderate White, Extra White, Natural Choice, Pure White), four stains (Wheat, Cherry, Fruitwood, Cordovan) and a clear lacquer topcoat. Primed interior is also available. Optional interior wood species include vertical grain Douglas Fir, Mahogany and Pacific Coast Red Alder.

**FRAME**

Frame is assembled from select kiln-dried pine AuraLast® wood on all exterior parts. Exterior surface is covered with .050 gauge extruded aluminum cladding. Standard jamb width is 4-9/16". Radius frames are produced in only three different radii: 90-9/32", 37-19/16", and 31-19/32".

**PANELS**

1-23/32" thick select kiln-dried pine AuraLast® wood. Exterior surface is covered with .024 gauge roll formed aluminum cladding. The top and bottom rails are formed from solid Western Pine veneers laminated to a kiln dried edge-and-end-glued core, while the stiles have the same veneer laminated to a Timberstrand core. The standard layout is 4-5/8" top rail and stiles and a 6-5/8" bottom rail. Other door rail options include wide bottom rail, lock rail and raised panels.

**GLAZING**

Insulating glass is constructed from two panes of tempered glass, utilizing a continuous roll formed stainless steel spacer with dual seal sealant. A computer-controlled application of clear silicone is used to bed the exterior of the insulating glass into the panel. An acrylic sealant is used to bed the interior. All insulating glass units comply with the performance requirements of IGCC in accordance with either ASTM E774 or E2190.

**GLAZING OPTIONS - TEMPERED**

Tempered insulating glass available in Low-E with Argon, Low-E, Low-E 366, Clear, Neat Glass, Seedy Reamy, tinted, reflective, or obscure, or other specialty glass as specified. Preserve® film is a 0.003" thick polyethylene film with a low tack acrylic adhesive applied to the glass for protection during shipping and installation. Installations at 4,000 foot elevations and higher require a capillary tube to equalize environmental stress (otherwise known as High Altitude glazing). High altitude glazing does not allow the use of Argon as listed under glazing options

**WEATHER-STRIPPING**

Engineered system with dual foam filled bulb seal compressed between the exterior of the panel and the frame in a continuous plane on all four sides.

**SILL**

The sill is a dark bronze anodized aluminum with oak interior trim. A vinyl fin-and-bulb bottom door sweep is applied. An optional handicapped sill with a maximum height of 1/2" is available to meet the standards set forth by the ADA for handicapped access.

**HARDWARE**

The door panels are mounted into the frame utilizing 4" x 4" heavy gauge solid brass hinges with stainless steel pins. Three hinges are used on 6-8 and 7-0 heights, and four hinges on all larger heights. Optional adjustable hinges are also available providing both vertical and horizontal adjustment. The standard finish for all hinges is Polished Brass, with optional finishes available in Antique Brass, Polished Chrome, Stainless Steel Satin, Oil Rubbed Bronze, White Powder Coat, and Black Powder Coat, Brushed Chrome, and PVD Brass. The standard locking system is a single point mortise with lever handle, and thumb turn dead bolt, shipped separately for field installation. Matching dummy handle sets are included for French Door applications. Optional multipoint lock systems are factory installed securing the active panel at three points. The system is manually activated from the handle.

**GRILLES**

**SDL** (Simulated Divided Lites) - extruded aluminum muntins permanently applied to the exterior of the insulating glass unit (not available on textured glass) in 7/8", 1-1/8", or 1-3/8" widths. Profiles are bead stop in all widths, and a putty profile in the 7/8" and 1-1/8" widths only. 1" Copper SDL is also available. SDL is standard with a light bronze internal shadow bar to give a true divided lite appearance. As an option, SDL may be ordered with a silver shadow bar or without a shadow bar. Clear wood interior muntin bars match the exterior muntin width and are permanently bonded to the interior of the glass. Also available is a 2-5/16" SDL bar, which simulates a double-hung checkrail.

**Full Surround Removable Wood Grilles** - Rectangular, unfinished interior clear pine wood grilles in 7/8", 1-1/8", and 1-3/8" are available in patterns selected by the owner.

**GBG** (Grilles between the Glass) - 5/8" flat, 23/32" contour, or 1" contour grilles mounted between the glass panes suspended within the air cavity.

**EXTERIOR TRIM**

Nail flange and drip cap standard with optional extruded aluminum brickmould, 3-1/2" flat, 3-1/2" Adams and Manchester trims. Optional mull covers to accommodate 1" (spread only), 2", 3-1/2" and 6" spread and stud pocket mull.

**EXTENSION JAMBS**

Extension jambs are available for wall depths up to 6-11/16".

*Continued on next page*

---

**PRODUCT SPECIFICATIONS**

---

**INSTALLATION**

Installation per JELD-WEN Installation Method for Metal Clad Patio Doors. See [www.jeld-wen.com/resources](http://www.jeld-wen.com/resources) for instructions.

**PERFORMANCE**

**ANSI/AAMA/NWDA/101/I.S.2-97**  
**AMMA/WDMA/CSA 101/I.S.2/A440-05**  
**WDMA Hallmark Certified**

See [www.jeld-wen.com](http://www.jeld-wen.com) for architectural and performance information.

**QUICK SPEC GUIDE**

SPECIFICATION	STANDARD FEATURES	OPTIONAL FEATURES <i>Some options may require additional lead times. Consult your JELD-WEN Sales Representative.</i>		
<b>EXTERIOR FINISH</b>	<ul style="list-style-type: none"> <li>• Brilliant White</li> <li>• Chestnut Bronze</li> <li>• Desert Sand</li> <li>• French Vanilla</li> <li>• Mesa Red</li> <li>• Hartford Green</li> <li>• Black Licorice</li> <li>• Heirloom White</li> <li>• Hunter Green</li> <li>• Redwood</li> <li>• Sage Brown</li> <li>• Smoke</li> </ul>	<ul style="list-style-type: none"> <li>• Black Emerald</li> <li>• Bone White</li> <li>• Bronze</li> <li>• Buckskin</li> <li>• Cambridge White</li> <li>• Capri Blue</li> <li>• Cascade</li> <li>• Champagne</li> <li>• Clover Mist</li> <li>• Dark Buckskin</li> <li>• Dark Ivy</li> <li>• Deep Summer</li> <li>• Garnet</li> <li>• Haverstraw</li> <li>• Hudson Blue</li> <li>• Ivory</li> <li>• Ivy</li> <li>• Liberty Blue</li> <li>• Mocha Cream</li> <li>• Mosaic Green</li> <li>• Pueblo Tan</li> <li>• Rosewood</li> <li>• Scarlet Haze</li> <li>• Sea Foam</li> <li>• Teal</li> <li>• Wedgewood</li> <li>• White</li> <li>• Clear Satin Anodized</li> <li>• Custom Color Matching</li> </ul> <div style="border: 1px solid black; padding: 5px; margin-top: 10px;"> <p>Panel Only:</p> <ul style="list-style-type: none"> <li>• Bright Copper</li> <li>• Speckled Patina Copper</li> <li>• Hand Rubbed Patina Copper</li> </ul> </div>		
<b>EXTERIOR TRIM</b>	<ul style="list-style-type: none"> <li>• Drip Cap &amp; Nailing Fin</li> </ul>	<ul style="list-style-type: none"> <li>• Extruded Aluminum Brickmould</li> <li>• Adams Casing</li> <li>• 3-1/2" Flat Casing</li> <li>• Manchester Casing</li> <li>• Folding Nailing Fin</li> </ul>		
<b>INTERIOR WOOD</b>	<ul style="list-style-type: none"> <li>• Western Pine</li> </ul>	<ul style="list-style-type: none"> <li>• Pacific Coast Red Alder</li> <li>• Vertical Grain Douglas Fir</li> <li>• Mahogany</li> </ul>		
<b>INTERIOR FINISH</b>	<ul style="list-style-type: none"> <li>• Natural</li> </ul>	<ul style="list-style-type: none"> <li>• Priming Available</li> </ul> <p>Pre-finished Interior Options are:</p> <ul style="list-style-type: none"> <li>• Paint - Pure White, Extra White, Natural Choice, Moderate White</li> <li>• Stain - Wheat, Fruitwood, Cherry, Cordovan</li> <li>• Clear Lacquer</li> </ul>		
<b>SIZE</b>	<ul style="list-style-type: none"> <li>• Width: 2-0, 2-6, 2-8, 3-0, 3-6, 5-0, 5-4, 6-0, 7-6, 8-0, 9-0</li> <li>• Height: 6-8, 7-0, 8-0, 9-0</li> </ul>	<ul style="list-style-type: none"> <li>• Any Panel Width: 2-0 to 3-6 (Certain restrictions apply)</li> <li>• Any Panel Height: 4-0 to 10-0 (Certain restrictions apply)</li> </ul>		
<b>GLAZING (ALL TEMPERED)</b>	<ul style="list-style-type: none"> <li>• Low-E Tempered Insulating Glass (with Argon)</li> <li>• Preserve® Protective Film</li> </ul>	<table style="width: 100%; border: none;"> <tr> <td style="vertical-align: top;"> <ul style="list-style-type: none"> <li>• Clear</li> <li>• Low-E 366</li> <li>• Obscure</li> <li>• Tints: Bronze, Gray, Solex</li> <li>• Reflective: Bronze and Gray</li> <li>• Glue Chip</li> </ul> </td> <td style="vertical-align: top;"> <ul style="list-style-type: none"> <li>• Safety Laminated in Clear, Bronze or Gray</li> <li>• Neat Glass</li> <li>• Seedy Reamy</li> <li>• Rain</li> <li>• Narrow Reed</li> <li>• Impact Resistant</li> </ul> </td> </tr> </table> <ul style="list-style-type: none"> <li>• High Altitude (Breather Tube, no Argon)</li> </ul>	<ul style="list-style-type: none"> <li>• Clear</li> <li>• Low-E 366</li> <li>• Obscure</li> <li>• Tints: Bronze, Gray, Solex</li> <li>• Reflective: Bronze and Gray</li> <li>• Glue Chip</li> </ul>	<ul style="list-style-type: none"> <li>• Safety Laminated in Clear, Bronze or Gray</li> <li>• Neat Glass</li> <li>• Seedy Reamy</li> <li>• Rain</li> <li>• Narrow Reed</li> <li>• Impact Resistant</li> </ul>
<ul style="list-style-type: none"> <li>• Clear</li> <li>• Low-E 366</li> <li>• Obscure</li> <li>• Tints: Bronze, Gray, Solex</li> <li>• Reflective: Bronze and Gray</li> <li>• Glue Chip</li> </ul>	<ul style="list-style-type: none"> <li>• Safety Laminated in Clear, Bronze or Gray</li> <li>• Neat Glass</li> <li>• Seedy Reamy</li> <li>• Rain</li> <li>• Narrow Reed</li> <li>• Impact Resistant</li> </ul>			

*Continued on next page*

QUICK SPEC GUIDE

SPECIFICATION	STANDARD FEATURES	OPTIONAL FEATURES <i>Some options may require additional lead times. Consult your JELD-WEN Sales Representative.</i>
<b>GRILLES</b>		SDL Bead Profile: <ul style="list-style-type: none"> <li>• 7/8", 1-1/8", 1-3/8", 2-5/16" with Light Bronze Shadow Bar</li> <li>• 7/8", 1-1/8", 1-3/8", 2-5/16" with Silver Shadow Bar</li> <li>• 7/8", 1-1/8", 1-3/8", 2-5/16" with No Shadow Bar</li> </ul> SDL Putty Profile: <ul style="list-style-type: none"> <li>• 7/8" and 1-1/8" with Light Bronze Shadow Bar</li> <li>• 7/8" and 1-1/8" with Silver Shadow Bar</li> <li>• 7/8" and 1-1/8" with No Shadow Bar</li> </ul> <ul style="list-style-type: none"> <li>• 1" Copper SDL</li> </ul> GBG (Grilles between the Glass): <ul style="list-style-type: none"> <li>• 5/8" Flat, 23/32" Contour, 1" Contour</li> </ul> Full Surround: <ul style="list-style-type: none"> <li>• 7/8", 1-1/8", 1-3/8" Wood Grilles</li> </ul>
<b>HARDWARE</b>	<ul style="list-style-type: none"> <li>• 4 x 4 Heavy Gauge Hinges</li> <li>• Single Point Mortise Lock with Lever Handle</li> </ul>	<ul style="list-style-type: none"> <li>• Adjustable Hinges</li> <li>• Multipoint Manually Activated Lock</li> </ul>
<b>HARDWARE COLOR</b>	<ul style="list-style-type: none"> <li>• Polished Brass</li> </ul>	<ul style="list-style-type: none"> <li>• Antique Brass</li> <li>• Polished Chrome</li> <li>• Brushed Chrome</li> <li>• Oil Rubbed Bronze</li> <li>• White Powder Coat</li> <li>• Black Powder Coat</li> </ul>
<b>JAMB</b>	<ul style="list-style-type: none"> <li>• Applied, 5/4</li> <li>• 4-9/16"</li> </ul>	<ul style="list-style-type: none"> <li>• Up to 6-11/16"*</li> </ul> <p><i>*6-11/16" only available with Folding Nailing Flange option</i></p>

**GENERAL INFORMATION**

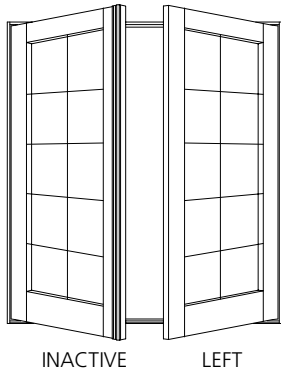

**DIMENSIONAL DOORS**

Clad out-swing patio doors may be specified as "dimensional" by adjusting the desired rough opening width or height in 1/4" increments from standard.

Clad out-swing patio doors are available in single, twin, triple and quad panel doors. Transoms are available to match the variety of door sizes. The standard size range includes sizes specifically designed for replacement of older patio door models in existing structures, as well as a full range of "true size" products for architectural consistency.

**OPERATION**

Clad out-swing patio doors are available in a full range of operating styles. Single panel doors may be specified as stationary (non-venting) or can operate left or right. Center swing two-or three-panel doors are available with left or right operation. French doors feature two operating panels (one active, which opens first; and one inactive, which closes first), and are available in two-panel and four-panel styles. Configuration and handing is based on viewing the door from the exterior.

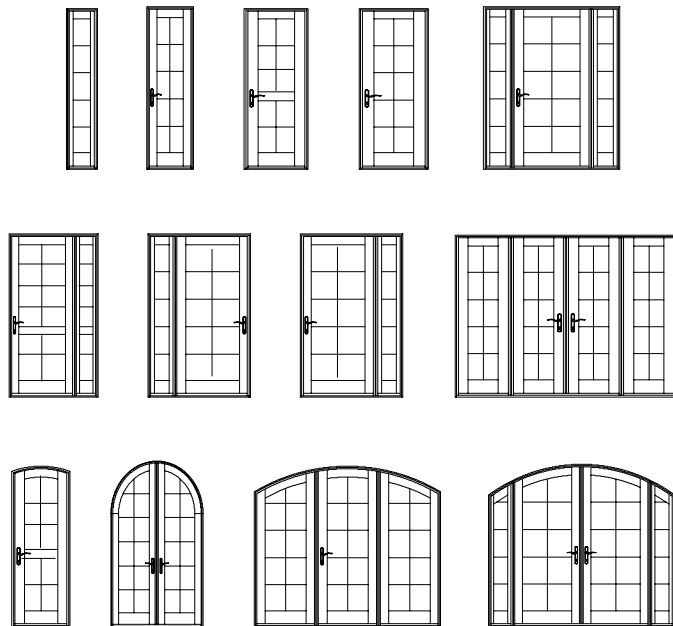

**MULTIPLE ASSEMBLIES**

Clad out-swing patio doors are available in a wide variety of multiple panel configurations from the factory, all of which are assembled with continuous sills. Clad out-swing patio doors may be mulled below, or beside other clad door and clad window products. Factory assembled mulls are limited in height (100"), width (150"), and a total area (75 square feet).

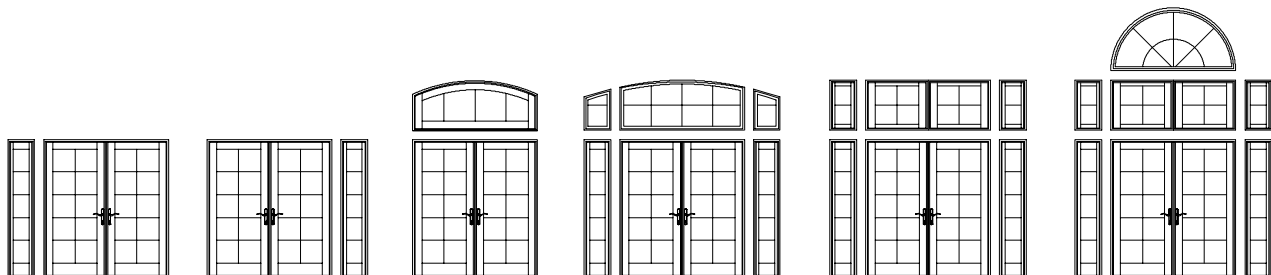

**ELEVATION NOTES**

ELEVATION DRAWINGS UTILIZE A LIMITED NUMBER OF PROJECTED LINES TO PRODUCE A RUDIMENTARY DRAWING INTENDED TO BE USED IN A SMALL GRAPHICAL SCALE. ELEVATIONS ARE VIEWED PERPENDICULAR FROM THE EXTERIOR OF THE STRUCTURE. IF MORE DIMENSIONS ARE NEEDED, USE THE SECTION DRAWINGS FOR MORE COMPLETE DEPICTIONS.

M.O. Brickmould  
M.O. Adams/Flat Casing  
Rough Opening  
Frame Size  
Glass Size

41 1/4" [ 1048 ]  
44 5/16" [ 1126 ]  
38 3/4" [ 984 ]  
38" [ 365 ]  
26 5/8" [ 676 ]

Masonry Openings for Brickmould, Flat & Adams Casing. Vertical measurements for transoms include sill nose. (Subtract 1/2" from Masonry Opening for Unit Size)

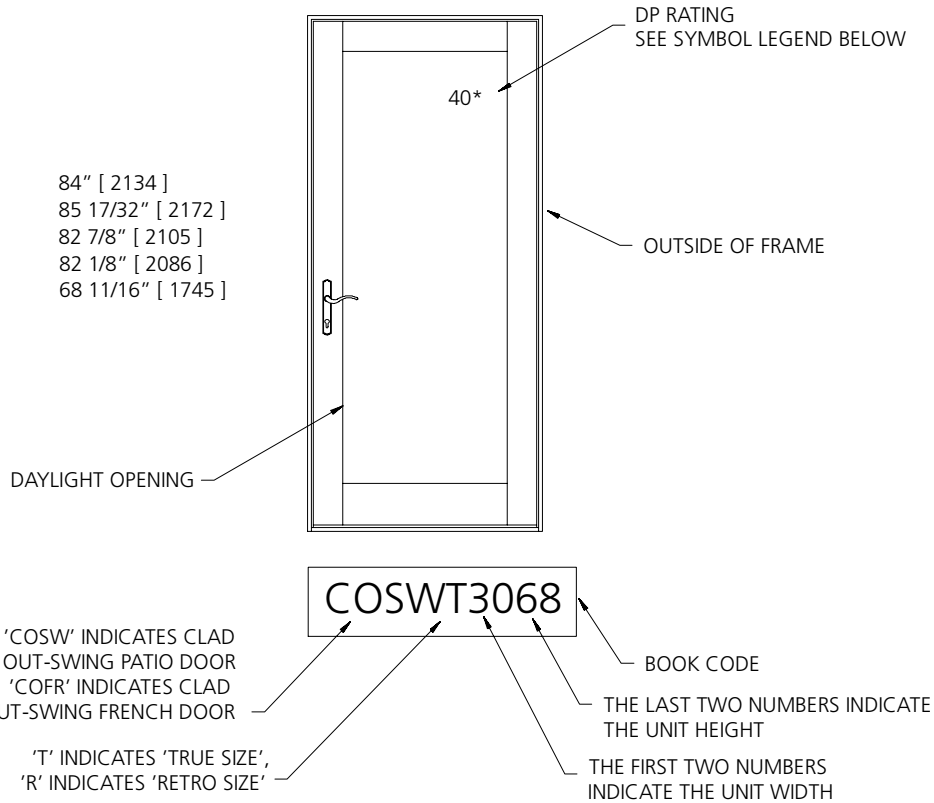

**GENERAL SWINGING DOOR NOTES**

1. CLAD OUT-SWING PATIO DOOR (COSW / COFR) UNITS ARE AVAILABLE AS OPERATING OR STATIONARY UNITS.
2. UNIT ELEVATIONS ARE SHOWN WITHOUT EXTERIOR TRIM. UNIT SIZES & MASONRY OPENING DIMENSIONS WILL CHANGE WITH THE ADDITION OF EXTERIOR TRIM. SEE THE 'UNIT SIZING, ROUGH OPENINGS & MASONRY OPENINGS' PAGE FOR EXTERIOR TRIM EFFECTS.
3. OPERATING UNITS ARE AVAILABLE AS LEFT OR RIGHT HAND OPERATION.
4. HANDICAP SILL, 10 1/4" BOTTOM RAILS, INTERMEDIATE LOCK RAILS AND RAISED PANELS ARE AVAILABLE FOR ALL UNITS.

**ELEVATION SYMBOL LEGEND:**

- S** PANEL IS AVAILABLE AS STATIONARY ONLY.
- ##\*** NUMBER INDICATES DESIGN PRESSURE (DP) RATING WITH STANDARD GLAZING. OPERATING UNITS UTILIZE MULTI-POINT LOCKING HARDWARE FOR DP RATINGS.

### 1-PANEL UNITS

**M.O. BRICKMOULD**  
**M.O. ADAMS/FLAT CASING**  
**ROUGH OPENING**  
**FRAME SIZE**  
**DAYLIGHT OPENING**

27 1/4" [692]  
 30 5/16" [770]  
 24 3/4" [629]  
 24" [610]  
 12 5/8" [321]

33 1/4" [845]  
 36 5/16" [922]  
 30 3/4" [781]  
 30" [762]  
 18 5/8" [473]

35 1/4" [895]  
 38 5/16" [973]  
 32 3/4" [832]  
 32" [813]  
 20 5/8" [524]

39 1/4" [997]  
 42 5/16" [1075]  
 36 3/4" [933]  
 36" [914]  
 24 5/8" [627]

81" [2057]  
 82 17/32" [2096]  
 79 7/8" [2029]  
 79 1/8" [2010]  
 65 11/16" [1668]

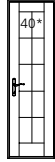

COSWR2068

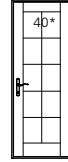

COSWR2668

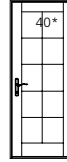

COSWR2868

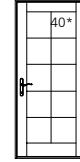

COSWR3068

97" [2464]  
 98 17/32" [2503]  
 95 7/8" [2435]  
 95 1/8" [2416]  
 81 1/16" [2075]

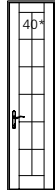

COSWR2080

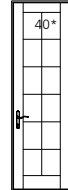

COSWR2680

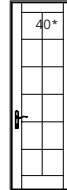

COSWR2880

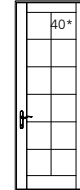

COSWR3080

109" [2769]  
 110 17/32" [2807]  
 107 7/8" [2740]  
 107 1/8" [2721]  
 93 11/16" [2380]

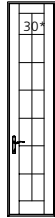

COSWR2090

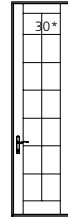

COSWR2690

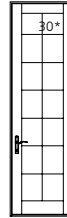

COSWR2890

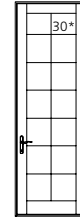

COSWR3090

**ELEVATION SYMBOL LEGEND:**

**M.O.** = MASONRY OPENING  
 VALUES IN ( ) ARE NUMBER OF DAYLIGHT OPENINGS PER UNIT  
 VALUES IN [ ] ARE IN MILLIMETER CONVERSIONS

**S** PANEL IS AVAILABLE AS STATIONARY ONLY.

**##** NUMBER INDICATES DESIGN PRESSURE (DP) RATING  
 WITH STANDARD GLAZING. OPERATING UNITS UTILIZE  
 MULTI-POINT LOCKING HARDWARE FOR DP RATINGS.

Note: Elevations shown DO NOT have exterior trim.  
 Subtract 1/2" (12.7) from M.O. (Masonry Opening)  
 for Unit Size. For other Trim Options refer to the Unit  
 Sizing, Rough Opening & Masonry Openings page.

**M.O. BRICKMOULD**  
**M.O. ADAMS/FLAT CASING**  
**ROUGH OPENING**  
**FRAME SIZE**  
**DAYLIGHT OPENING**

17 3/8" [441]  
 20 7/16" [519]  
 14 7/8" [378]  
 14 1/8" [359]  
 7 1/2" [190]

19 3/8" [492]  
 22 7/16" [570]  
 16 7/8" [429]  
 16 1/8" [410]  
 9 1/2" [241]

21 3/8" [543]  
 24 7/16" [621]  
 18 7/8" [479]  
 18 1/8" [460]  
 11 1/2" [292]

29 1/4" [743]  
 32 5/16" [821]  
 26 3/4" [679]  
 26" [660]  
 14 5/8" [368]

35 1/4" [895]  
 38 5/16" [973]  
 32 3/4" [832]  
 32" [813]  
 20 5/8" [524]

37 1/4" [946]  
 40 5/16" [1024]  
 34 3/4" [883]  
 34" [864]  
 22 5/8" [571]

41 1/4" [1048]  
 44 5/16" [1126]  
 38 3/4" [984]  
 38" [965]  
 26 5/8" [676]

47 1/4" [1200]  
 50 5/16" [1278]  
 44 3/4" [1137]  
 44" [1118]  
 32 5/8" [829]

84" [2134]  
 85 17/32" [2172]  
 82 7/8" [2105]  
 68 1/8" [2086]  
 68 11/16" [1745]

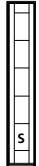

COSWT1068



COSWT1268



COSWT1468

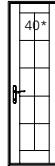

COSWT2068

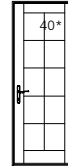

COSWT2668

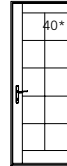

COSWT2868

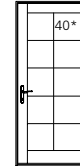

COSWT3068

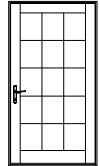

COSWT3668

88" [2235]  
 89 17/32" [2274]  
 86 7/8" [2206]  
 86 1/8" [2188]  
 72 11/16" [1846]



COSWT1070



COSWT1270



COSWT1470

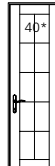

COSWT2070

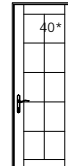

COSWT2670

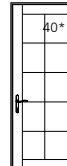

COSWT2870

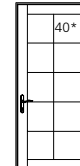

COSWT3070

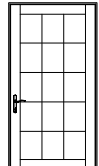

COSWT3670

100" [2540]  
 101 17/32" [2579]  
 98 7/8" [2511]  
 98 1/8" [2492]  
 84 11/16" [2151]

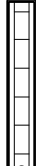

COSWT1080



COSWT1280



COSWT1480

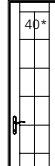

COSWT2080

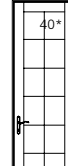

COSWT2680

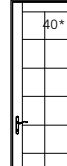

COSWT2880

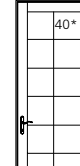

COSWT3080

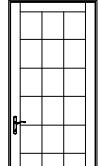

COSWT3680

112" [2845]  
 113 17/32" [2884]  
 110 7/8" [2816]  
 110 1/8" [2797]  
 96 11/16" [2456]

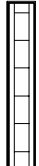

COSWT1090



COSWT1290



COSWT1490

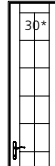

COSWT2090

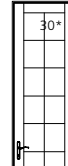

COSWT2690

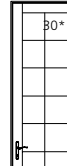

COSWT2890

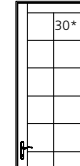

COSWT3090

SCALE: 1/8" = 1'



**2-PANEL UNITS**

**M.O. BRICKMOULD  
M.O. ADAMS/FLAT CASING  
ROUGH OPENING  
FRAME SIZE  
DAYLIGHT OPENING**

62 7/16" [1586]  
65 1/2" [1664]  
59 15/16" [1522]  
59 3/16" [1503]  
18 5/8" [473] (2)

81" [2057]  
82 17/32" [2096]  
79 7/8" [2029]  
79 1/8" [2010]  
65 11/16" [1668]

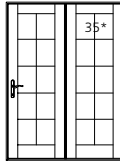

COSWR5068

97" [2464]  
98 17/32" [2503]  
95 7/8" [2435]  
95 1/8" [2416]  
81 11/16" [2075]

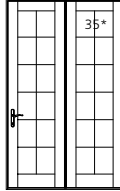

COSWR5080

109" [2769]  
110 17/32" [2807]  
107 7/8" [2740]  
107 1/8" [2721]  
93 11/16" [2380]

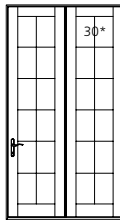

COSWR5090

66 7/16" [1688]  
69 1/2" [1765]  
63 15/16" [1624]  
63 3/16" [1605]  
20 5/8" [524] (2)

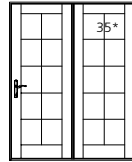

COSWR5468

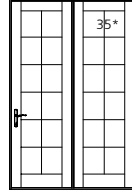

COSWR5480

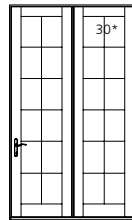

COSWR5490

74 7/16" [1891]  
77 1/2" [1969]  
71 15/16" [1827]  
71 3/16" [1808]  
24 5/8" [625] (2)

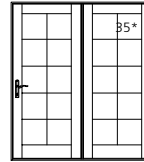

COSWR6068

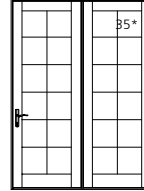

COSWR6080

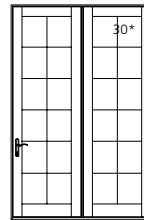

COSWR6090

**M.O. BRICKMOULD  
M.O. ADAMS/FLAT CASING  
ROUGH OPENING  
FRAME SIZE  
DAYLIGHT OPENING**

66 7/16" [1688]  
69 1/2" [1765]  
63 15/16" [1624]  
63 3/16" [1605]  
20 5/8" [524] (2)

84" [2134]  
85 17/32" [2172]  
82 7/8" [2105]  
82 1/8" [2086]  
68 11/16" [1745]

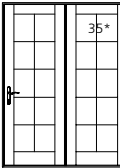

COSWT5068

88" [2235]  
89 17/32" [2274]  
86 7/8" [2207]  
86 1/8" [2188]  
72 11/16" [1846]

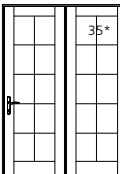

COSWT5070

100" [2540]  
101 17/32" [2579]  
98 7/8" [2511]  
98 1/8" [2492]  
84 11/16" [2151]

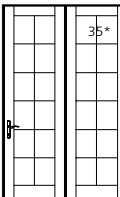

COSWT5080

112" [2845]  
113 17/32" [2884]  
110 7/8" [2816]  
110 1/8" [2797]  
96 11/16" [2456]

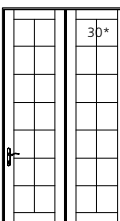

COSWT5090

70 7/16" [1789]  
73 1/2" [1867]  
67 15/16" [1726]  
67 3/16" [1707]  
22 5/8" [575] (2)

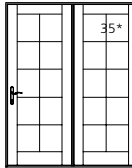

COSWT5468

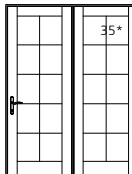

COSWT5470

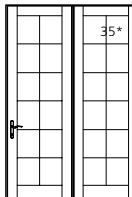

COSWT5480

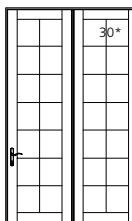

COSWT5490

78 7/16" [1992]  
81 1/2" [2070]  
75 15/16" [1929]  
75 3/16" [1910]  
26 5/8" [676] (2)

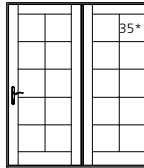

COSWT6068

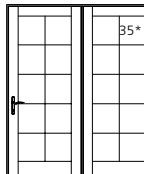

COSWT6070

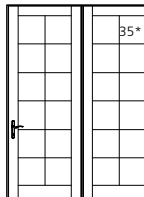

COSWT6080

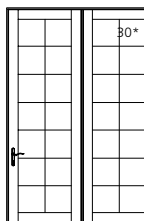

COSWT6090

90 7/16" [2297]  
93 1/2" [2375]  
87 15/16" [2234]  
87 3/16" [2215]  
32 5/8" [829] (2)

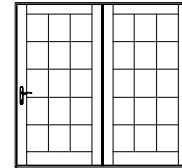

COSWT7068

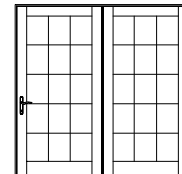

COSWT7070

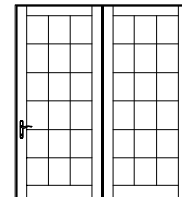

COSWT7080

**ELEVATION SYMBOL LEGEND:**

**M.O.** = MASONRY OPENING  
VALUES IN ( ) ARE NUMBER OF DAYLIGHT OPENINGS PER UNIT  
VALUES IN [ ] ARE IN MILLIMETER CONVERSIONS  
### NUMBER INDICATES DESIGN PRESSURE (DP) RATING  
WITH STANDARD GLAZING. OPERATING UNITS UTILIZE  
MULTI-POINT LOCKING HARDWARE FOR DP RATINGS.

Note: Elevations shown DO NOT have exterior trim.  
Subtract 1/2" (12.7) from M.O. (Masonry Opening)  
for Unit Size. For other Trim Options refer to the Unit  
Sizing, Rough Opening & Masonry Openings page.

SCALE: 1/8" = 1'

### 3-PANEL UNITS

**M.O. BRICKMOULD**  
**M.O. ADAMS/FLAT CASING**  
**ROUGH OPENING**  
**FRAME SIZE**  
**DAYLIGHT OPENING**

91 5/8" [2327]  
94 11/16" [2405]  
89 1/8" [2264]  
88 3/8" [2245]  
18 3/8" [473] (3)

97 5/8" [2480]  
100 11/16" [2557]  
95 1/8" [2416]  
94 3/8" [2397]  
20 5/8" [524] (3)

109 5/8" [2784]  
112 11/16" [2862]  
107 1/8" [2721]  
106 3/8" [2702]  
24 5/8" [625] (3)

81" [2057]  
82 17/32" [2096]  
79 7/8" [2039]  
79 1/8" [2010]  
65 11/16" [1668]

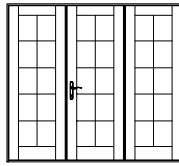

COSWR7668

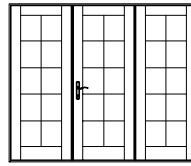

COSWR8068

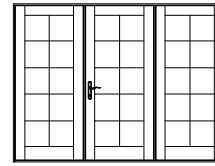

COSWR9068

97" [2464]  
98 17/32" [2503]  
95 7/8" [2435]  
95 1/8" [2416]  
81 11/16" [2075]

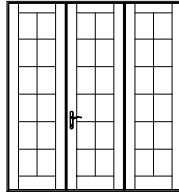

COSWR7680

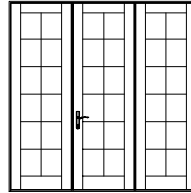

COSWR8080

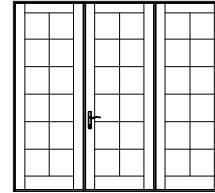

COSWR9080

109" [2769]  
110 17/32" [2807]  
107 7/8" [2740]  
107 1/8" [2721]  
93 11/16" [2380]

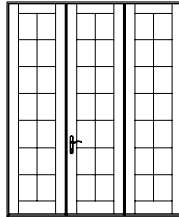

COSWR7690

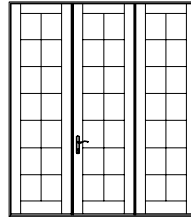

COSWR8090

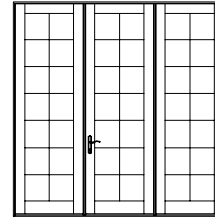

COSWR9090

**M.O. BRICKMOULD**  
**M.O. ADAMS/FLAT CASING**  
**ROUGH OPENING**  
**FRAME SIZE**  
**DAYLIGHT OPENING**

97 5/8" [2480]  
100 11/16" [2557]  
95 1/8" [2416]  
94 3/8" [2397]  
20 5/8" [524] (3)

103 5/8" [2632]  
106 11/16" [2710]  
101 1/8" [2569]  
100 3/8" [2550]  
22 5/8" [575] (3)

115 5/8" [2937]  
118 11/16" [3015]  
113 1/8" [2873]  
112 3/8" [2854]  
26 5/8" [676] (3)

84" [2134]  
85 17/32" [2172]  
82 7/8" [2105]  
82 1/8" [2086]  
68 11/16" [1745]

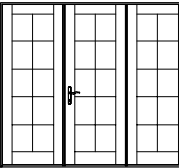

COSWT7668

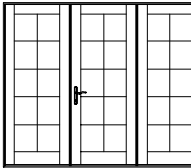

COSWT8068

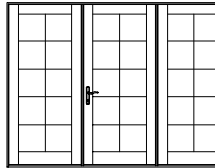

COSWT9068

88" [2235]  
89 17/32" [2274]  
86 7/8" [2206]  
86 1/8" [2188]  
72 11/16" [1846]

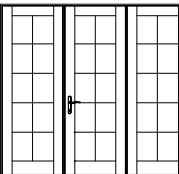

COSWT7670

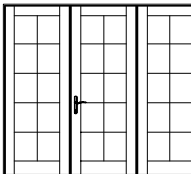

COSWT8070

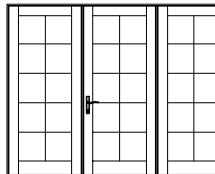

COSWT9070

100" [2540]  
101 17/32" [2579]  
97 7/8" [2511]  
98 1/8" [2492]  
84 11/16" [2151]

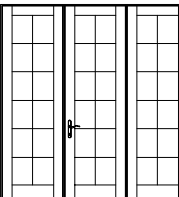

COSWT7680

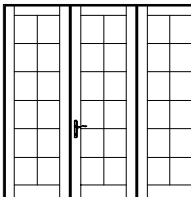

COSWT8080

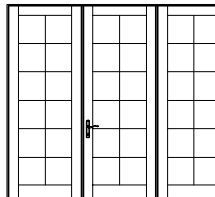

COSWT9080

112" [2845]  
113 17/32" [2884]  
110 7/8" [2816]  
110 1/8" [2797]  
96 11/16" [2456]

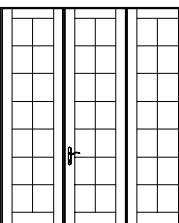

COSWT7690

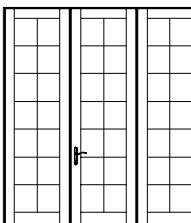

COSWT8090

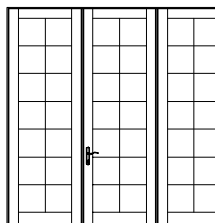

COSWT9090

Note: Elevations shown DO NOT have exterior trim. Subtract 1/2" (12.7) from M.O. (Masonry Opening) for Unit Size. For other Trim Options refer to the Unit Sizing, Rough Opening & Masonry Openings page.

SCALE: 1/8" = 1'

**ELEVATION SYMBOL LEGEND:**  
M.O. = MASONRY OPENING  
VALUES IN ( ) ARE NUMBER OF DAYLIGHT OPENINGS PER UNIT  
VALUES IN [ ] ARE IN MILLIMETER CONVERSIONS

### 2-PANEL FRENCH UNITS

**M.O. BRICKMOULD**  
**M.O. ADAMS/FLAT CASING**  
**ROUGH OPENING**  
**FRAME SIZE**  
**DAYLIGHT OPENING**

50 7/16" [1281]  
53 1/2" [1359]  
47 15/16" [1218]  
47 3/16" [1199]  
12 5/8" [321] (2)

62 7/16" [1586]  
65 1/2" [1664]  
59 15/16" [1522]  
59 3/16" [1503]  
18 5/8" [473] (2)

66 7/16" [1688]  
69 1/2" [1765]  
63 15/16" [1624]  
63 3/16" [1605]  
20 5/8" [524] (2)

74 7/16" [1891]  
77 1/2" [1969]  
71 15/16" [1827]  
71 3/16" [1808]  
24 5/8" [625] (2)

81" [2057]  
82 17/32" [2096]  
79 7/8" [2029]  
79 1/8" [2010]  
65 11/16" [1668]

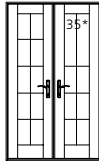

COFRR4068

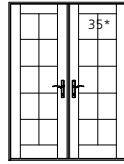

COFRR5068

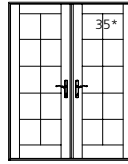

COFRR5468

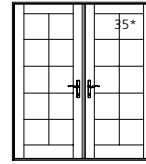

COFRR6068

97" [2464]  
98 17/32" [2503]  
95 7/8" [2435]  
95 1/8" [2416]  
81 11/16" [2075]

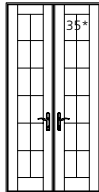

COFRR4080

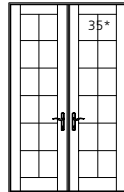

COFRR5080

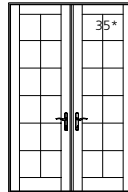

COFRR5480

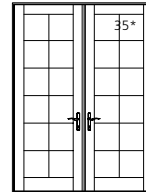

COFRR6080

109" [2769]  
110 17/32" [2807]  
107 7/8" [2740]  
107 1/8" [2721]  
93 11/16" [2380]

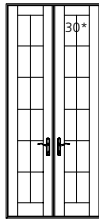

COFRR4090

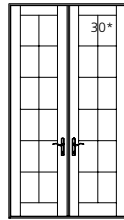

COFRR5090

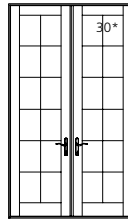

COFRR5490

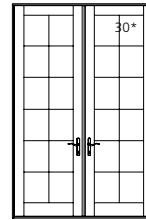

COFRR6090

**M.O. BRICKMOULD**  
**M.O. ADAMS/FLAT CASING**  
**ROUGH OPENING**  
**FRAME SIZE**  
**DAYLIGHT OPENING**

54 7/16" [1382]  
57 1/2" [1461]  
51 15/16" [1319]  
51 3/16" [1300]  
14 5/8" [371] (2)

66 7/16" [1688]  
69 1/2" [1765]  
63 15/16" [1624]  
63 3/16" [1605]  
20 5/8" [524] (2)

70 7/16" [1789]  
73 1/2" [1867]  
67 15/16" [1726]  
67 3/16" [1707]  
22 5/8" [575] (2)

78 7/16" [1992]  
81 1/2" [2070]  
75 15/16" [1929]  
75 3/16" [1910]  
26 5/8" [676] (2)

90 7/16" [2297]  
93 1/2" [2375]  
87 15/16" [2234]  
87 3/16" [2215]  
32 5/8" [829] (2)

84" [2134]  
85 17/32" [2172]  
82 7/8" [2105]  
82 1/8" [2086]  
68 11/16 [1745]

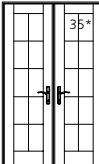

COFRT4068

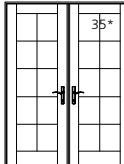

COFRT5068

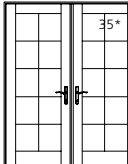

COFRT5468

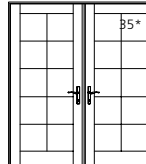

COFRT6068

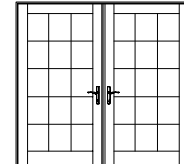

COFRT7068

88" [2235]  
89 17/32" [2274]  
86 7/8" [2207]  
86 1/8" [2188]  
72 11/16" [1846]

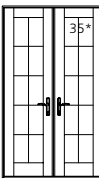

COFRT4070

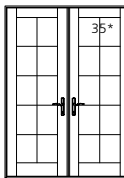

COFRT5070

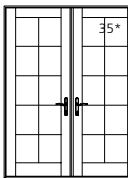

COFRT5470

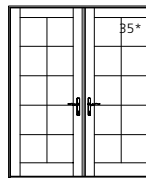

COFRT6070

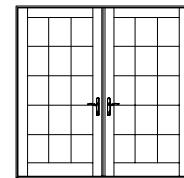

COFRT7070

100" [2540]  
101 17/32" [2579]  
98 7/8" [2511]  
98 1/8" [2492]  
84 11/16" [2151]

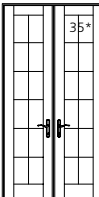

COFRT4080

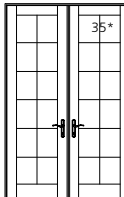

COFRT5080

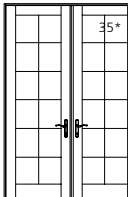

COFRT5480

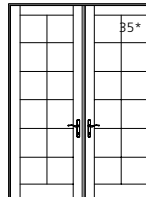

COFRT6080

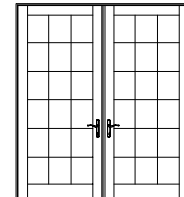

COFRT7080

112" [2845]  
113 17/32" [2884]  
110 7/8" [2816]  
110 1/8" [2797]  
96 11/16" [2456]

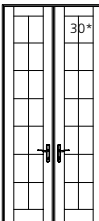

COFRT4090

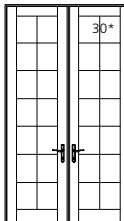

COFRT5090

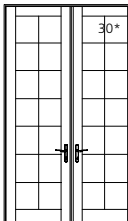

COFRT5490

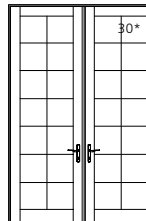

COFRT6090

**ELEVATION SYMBOL LEGEND:**  
**M.O.** = MASONRY OPENING  
VALUES IN ( ) ARE NUMBER OF DAYLIGHT OPENINGS PER UNIT  
VALUES IN [ ] ARE IN MILLIMETER CONVERSIONS  
### NUMBER INDICATES DESIGN PRESSURE (DP) RATING  
WITH STANDARD GLAZING. OPERATING UNITS UTILIZE  
MULTI-POINT LOCKING HARDWARE FOR DP RATINGS.

Note: Elevations shown DO NOT have exterior trim. Subtract 1/2" (12.7) from M.O. (Masonry Opening) for Unit Size. For other Trim Options refer to the Unit Sizing, Rough Opening & Masonry Openings page.

SCALE: 1/8" = 1'

#### 4-PANEL FRENCH UNITS

**M.O. BRICKMOULD**  
**M.O. ADAMS/FLAT CASING**  
**ROUGH OPENING**  
**FRAME SIZE**  
**DAYLIGHT OPENING**

81" [2057]  
 82 17/32" [2096]  
 79 7/8" [2029]  
 79 1/8" [2010]  
 65 11/16" [1668]

96 13/16" [2459]  
 99 7/8" [2537]  
 94 5/16" [2396]  
 93 9/16" [2376]  
 12 5/8" [321] (4)

120 13/16" [3069]  
 123 7/8" [3146]  
 118 5/16" [3005]  
 117 9/16" [2986]  
 18 5/8" [473] (4)

144 13/16" [3678]  
 147 7/8" [3756]  
 142 5/16" [3615]  
 141 9/16" [3596]  
 24 5/8" [625] (4)

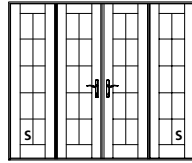

COFRR8068

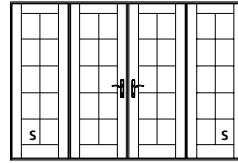

COFRR10068

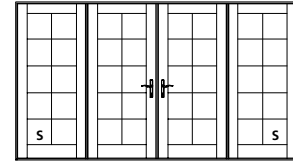

COFRR12068

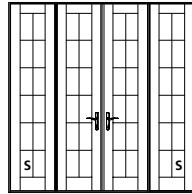

COFRR8080

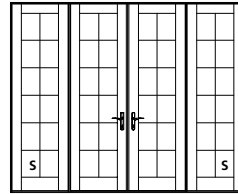

COFRR10080

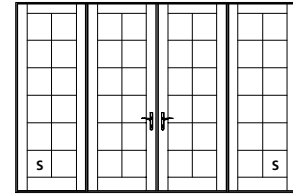

COFRR12080

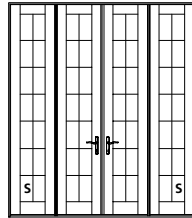

COFRR8090

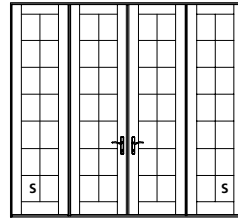

COFRR10090

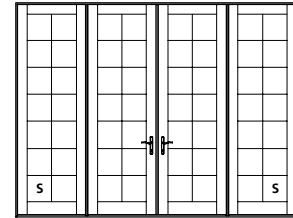

COFRR12090

**M.O. BRICKMOULD**  
**M.O. ADAMS/FLAT CASING**  
**ROUGH OPENING**  
**FRAME SIZE**  
**DAYLIGHT OPENING**

84" [2134]  
 85 17/32" [2172]  
 82 7/8" [2105]  
 82 1/8" [2086]  
 68 11/16" [1745]

104 13/16" [2662]  
 107 7/8" [2740]  
 102 5/16" [2599]  
 101 9/16" [2580]  
 14 5/8" [371] (4)

128 13/16" [3272]  
 131 7/8" [3350]  
 126 5/16" [3208]  
 125 9/16" [3189]  
 20 5/8" [524] (4)

152 13/16" [3881]  
 155 7/8" [3959]  
 150 5/16" [3818]  
 149 9/16" [3799]  
 26 5/8" [676] (4)

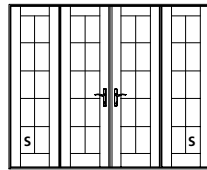

COFRT8068

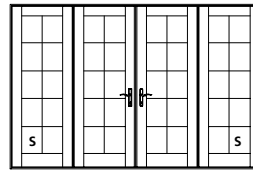

COFRT10068

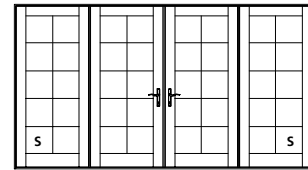

COFRT12068

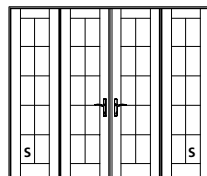

COFRT8070

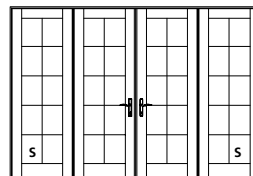

COFRT10070

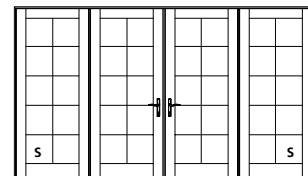

COFRT12070

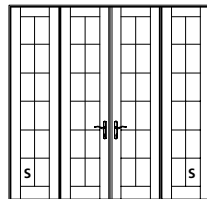

COFRT8080

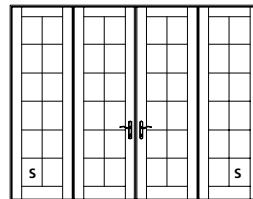

COFRT10080

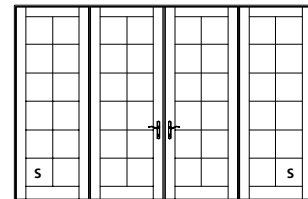

COFRT12080

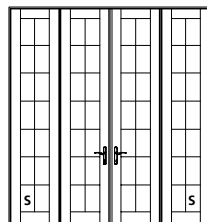

COFRT8090

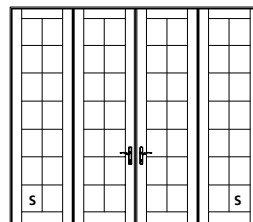

COFRT10090

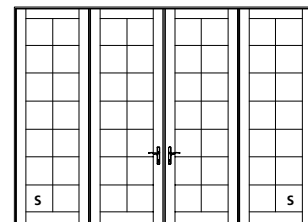

COFRT12090

**ELEVATION SYMBOL LEGEND:**

**M.O.** = MASONRY OPENING  
 VALUES IN ( ) ARE NUMBER OF DAYLIGHT OPENINGS PER UNIT  
 VALUES IN [ ] ARE IN MILLIMETER CONVERSIONS  
**S** PANEL IS AVAILABLE AS STATIONARY ONLY.

112" [2845]  
 113 17/32" [2884]  
 110 7/8" [2816]  
 110 1/8" [2797]  
 96 11/16" [2456]

Note: Elevations shown DO NOT have exterior trim. Subtract 1/2" (12.7) from M.O. (Masonry Opening) for Unit Size. For other Trim Options refer to the Unit Sizing, Rough Opening & Masonry Openings page.

SCALE: 1/8" = 1'

### SINGLE DOOR WITH SINGLE SIDELIGHT

M.O. BRICKMOULD	54 9/16" [1386]	56 9/16" [1437]	58 9/16" [1487]
M.O. ADAMS/FLAT CASING	57 5/8" [1464]	59 5/8" [1514]	61 5/8" [1565]
ROUGH OPENING	52 1/16" [1322]	54 1/16" [1373]	56 1/16" [1424]
FRAME SIZE	51 5/16" [1303]	53 5/16" [1354]	55 5/16" [1405]
DAYLIGHT OPENING	26 5/8" [676] - 7 1/2" [190]	26 5/8" [676] - 9 1/2" [241]	26 5/8" [676] - 11 1/2" [292]

84" [2134]  
85 17/32" [2172]  
87 7/8" [2205]  
88 1/8" [2235]  
88 11/16" [2266]

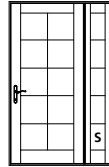

COSWT3068B10

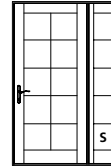

COSWT3068B12

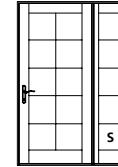

COSWT3068B14

88" [2235]  
89 17/32" [2274]  
88 7/8" [2266]  
88 1/8" [2235]  
72 11/16" [1846]

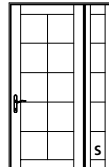

COSWT3070B10

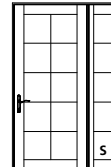

COSWT3070B12

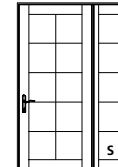

COSWT3070B14

100" [2540]  
101 17/32" [2579]  
98 7/8" [2511]  
98 1/8" [2492]  
84 11/16" [2151]

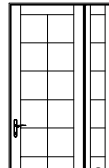

COSWT3080B10

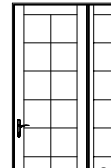

COSWT3080B12

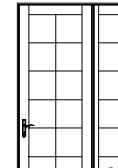

COSWT3080B14

112" [2845]  
113 17/32" [2884]  
110 7/8" [2816]  
110 1/8" [2797]  
96 11/16" [2456]

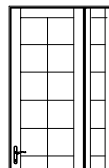

COSWT3090B10

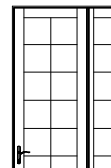

COSWT3090B12

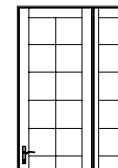

COSWT3090B14

M.O. BRICKMOULD	60 9/16" [1538]	62 9/16" [1589]	64 9/16" [1640]
M.O. ADAMS/FLAT CASING <td>63 5/8" [1616] <td>65 5/8" [1667] <td>67 5/8" [1718] </td></td></td>	63 5/8" [1616] <td>65 5/8" [1667] <td>67 5/8" [1718] </td></td>	65 5/8" [1667] <td>67 5/8" [1718] </td>	67 5/8" [1718]
ROUGH OPENING <td>58 1/16" [1475] <td>60 1/16" [1526] <td>62 1/16" [1576] </td></td></td>	58 1/16" [1475] <td>60 1/16" [1526] <td>62 1/16" [1576] </td></td>	60 1/16" [1526] <td>62 1/16" [1576] </td>	62 1/16" [1576]
FRAME SIZE <td>57 5/16" [1456] <td>59 5/16" [1507] <td>61 5/16" [1557] </td></td></td>	57 5/16" [1456] <td>59 5/16" [1507] <td>61 5/16" [1557] </td></td>	59 5/16" [1507] <td>61 5/16" [1557] </td>	61 5/16" [1557]
DAYLIGHT OPENING <td>32 5/8" [829] - 7 1/2" [190]</td> <td>32 5/8" [829] - 9 1/2" [241]</td> <td>32 5/8" [829] - 11 1/2" [292]</td>	32 5/8" [829] - 7 1/2" [190]	32 5/8" [829] - 9 1/2" [241]	32 5/8" [829] - 11 1/2" [292]

84" [2134]  
85 17/32" [2172]  
87 7/8" [2205]  
88 1/8" [2235]  
88 11/16" [2266]

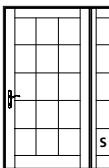

COSWT3668B10

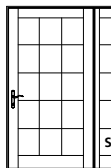

COSWT3668B12

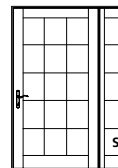

COSWT3668B14

88" [2235]  
89 17/32" [2274]  
88 7/8" [2266]  
88 1/8" [2235]  
72 11/16" [1846]

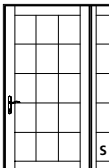

COSWT3670B10

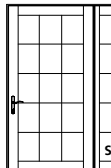

COSWT3670B12

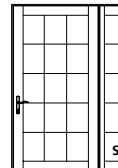

COSWT3670B14

100" [2540]  
101 17/32" [2579]  
98 7/8" [2511]  
98 1/8" [2492]  
84 11/16" [2151]

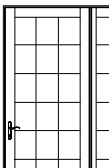

COSWT3680B10

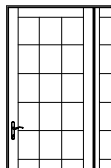

COSWT3680B12

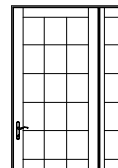

COSWT3680B14

**ELEVATION SYMBOL LEGEND:**  
M.O. = MASONRY OPENING  
VALUES IN ( ) ARE NUMBER OF DAYLIGHT OPENINGS PER UNIT  
VALUES IN [ ] ARE IN MILLIMETER CONVERSIONS  
S PANEL IS AVAILABLE AS STATIONARY ONLY.

Note: Elevations shown DO NOT have exterior trim.  
Subtract 1/2" (12.7) from M.O. (Masonry Opening)  
for Unit Size. For other Trim Options refer to the Unit  
Sizing, Rough Opening & Masonry Openings page.

SCALE: 1/8" = 1'

### SINGLE DOOR WITH TWO SIDELIGHTS

**M.O. BRICKMOULD**  
**M.O. ADAMS/FLAT CASING**  
**ROUGH OPENING**  
**FRAME SIZE**  
**DAYLIGHT OPENING**

67 7/8" [1724]  
70 15/16" [1802]  
65 3/8" [1661]  
64 5/8" [1641]  
26 5/8" [676] - 7 1/2" [190] (2)

71 7/8" [1826]  
74 15/16" [1903]  
69 3/8" [1762]  
68 5/8" [1743]  
26 5/8" [676] - 9 1/2" [241] (2)

75 7/8" [1927]  
78 15/16" [2005]  
73 3/8" [1864]  
72 5/8" [1845]  
26 5/8" [676] - 11 1/2" [292] (2)

84" [2134]  
85 17/32" [2172]  
82 7/8" [2105]  
82 1/8" [2086]  
68 11/16" [1745]

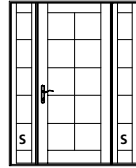

COSWT3068F10

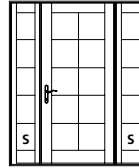

COSWT3068F12

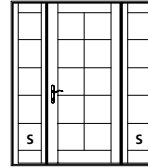

COSWT3068F14

88" [2235]  
89 17/32" [2274]  
86 7/8" [2206]  
86 1/8" [2188]  
72 11/16" [1846]

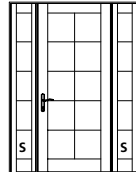

COSWT3070F10

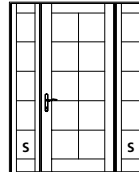

COSWT3070F12

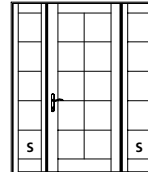

COSWT3070F14

100" [2540]  
101 17/32" [2579]  
98 7/8" [2511]  
98 1/8" [2492]  
84 11/16" [2151]

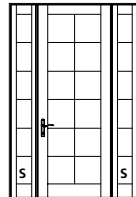

COSWT3080F10

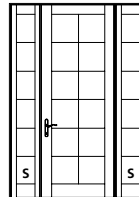

COSWT3080F12

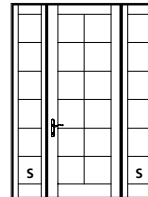

COSWT3080F14

112" [2845]  
113 17/32" [2884]  
110 7/8" [2816]  
110 1/8" [2797]  
96 11/16" [2456]

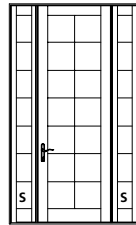

COSWT3090F10

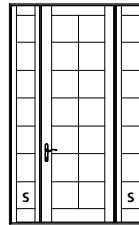

COSWT3090F12

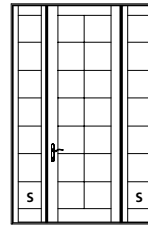

COSWT3090F14

**M.O. BRICKMOULD**  
**M.O. ADAMS/FLAT CASING**  
**ROUGH OPENING**  
**FRAME SIZE**  
**DAYLIGHT OPENING**

73 7/8" [1876]  
76 15/16" [1954]  
71 3/8" [1813]  
70 5/8" [1794]  
32 5/8" [829] - 7 1/2" [190] (2)

77 7/8" [1978]  
80 15/16" [2056]  
75 3/8" [1915]  
74 5/8" [1895]  
32 5/8" [829] - 9 1/2" [241] (2)

81 5/16" [2065]  
84 15/16" [2157]  
79 3/8" [2016]  
78 5/8" [1997]  
32 5/8" [829] - 11 1/2" [292] (2)

84" [2134]  
85 17/32" [2172]  
82 7/8" [2105]  
82 1/8" [2086]  
68 11/16" [1745]

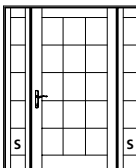

COSWT3668F10

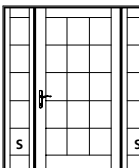

COSWT3668F12

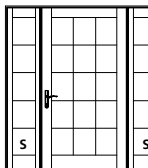

COSWT3668F14

88" [2235]  
89 17/32" [2274]  
86 7/8" [2206]  
86 1/8" [2188]  
72 11/16" [1846]

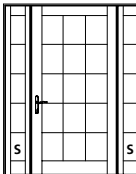

COSWT3670F10

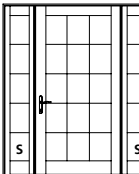

COSWT3670F12

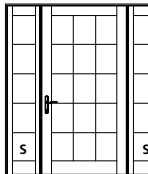

COSWT3670F14

100" [2540]  
101 17/32" [2579]  
98 7/8" [2511]  
98 1/8" [2492]  
84 11/16" [2151]

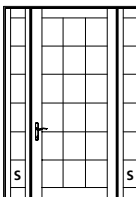

COSWT3680F10

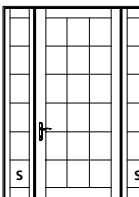

COSWT3680F12

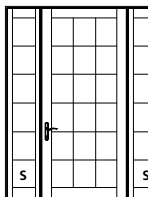

COSWT3680F14

**ELEVATION SYMBOL LEGEND:**

**M.O.** = MASONRY OPENING  
VALUES IN ( ) ARE NUMBER OF DAYLIGHT OPENINGS PER UNIT  
VALUES IN [ ] ARE IN MILLIMETER CONVERSIONS  
**S** PANEL IS AVAILABLE AS STATIONARY ONLY.

Note: Elevations shown DO NOT have exterior trim. Subtract 1/2" (12.7) from M.O. (Masonry Opening) for Unit Size. For other Trim Options refer to the Unit Sizing, Rough Opening & Masonry Openings page.

SCALE: 1/8" = 1'

**FRENCH DOOR WITH TWO SIDELIGHTS**  
**5-0 UNITS**

**M.O. BRICKMOULD**  
**M.O. ADAMS/FLAT CASING**  
**ROUGH OPENING**  
**FRAME SIZE**  
**DAYLIGHT OPENING**

93 1/16" [2364]  
96 1/8" [2442]  
90 9/16" [2300]  
89 13/16" [2281]  
20 5/8" [524] (2) - 7 1/2" [190] (2)

97 1/16" [2465]  
100 1/8" [2543]  
94 9/16" [2402]  
93 13/16" [2383]  
20 5/8" [524] (2) - 9 1/2" [241] (2)

101 1/16" [2567]  
104 1/8" [2645]  
98 9/16" [2503]  
97 13/16" [2484]  
20 5/8" [524] (2) - 11 1/2" [292] (2)

84" [2134]  
85 17/32" [2172]  
82 7/8" [2105]  
83 1/8" [2086]  
68 11/16" [1745]

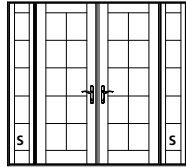

COFRT5068Q10

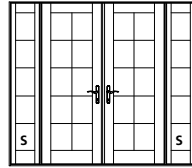

COFRT5068Q12

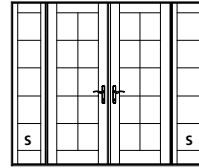

COFRT5068Q14

88" [2235]  
89 17/32" [2274]  
86 7/8" [2206]  
86 1/8" [2188]  
72 11/16" [1846]

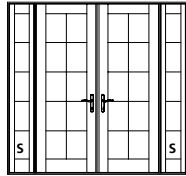

COFRT5070Q10

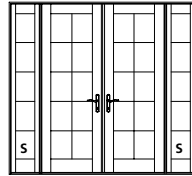

COFRT5070Q12

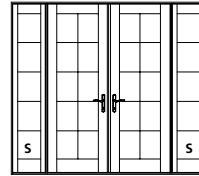

COFRT5070Q14

100" [2540]  
101 17/32" [2579]  
98 7/8" [2511]  
98 1/8" [2492]  
84 11/16" [2151]

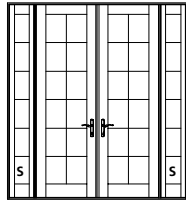

COFRT5080Q10

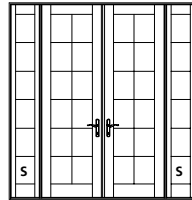

COFRT5080Q12

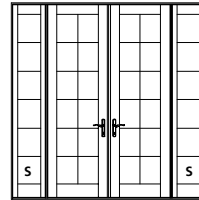

COFRT5080Q14

112" [2845]  
113 17/32" [2884]  
110 7/8" [2816]  
110 1/8" [2797]  
96 11/16" [2456]

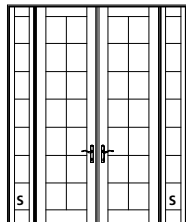

COFRT5090Q10

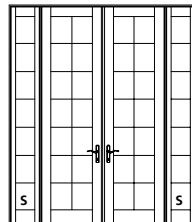

COFRT5090Q12

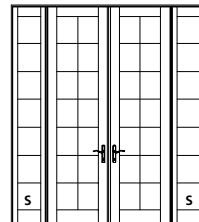

COFRT5090Q14

**ELEVATION SYMBOL LEGEND:**

**M.O.** = MASONRY OPENING  
VALUES IN ( ) ARE NUMBER OF DAYLIGHT OPENINGS PER UNIT  
VALUES IN [ ] ARE IN MILLIMETER CONVERSIONS  
**S** PANEL IS AVAILABLE AS STATIONARY ONLY.

Note: Elevations shown DO NOT have exterior trim. Subtract 1/2" (12.7) from M.O. (Masonry Opening) for Unit Size. For other Trim Options refer to the Unit Sizing, Rough Opening & Masonry Openings page.

SCALE: 1/8" = 1'

**FRENCH DOOR WITH TWO SIDELIGHTS**  
**5-4 UNITS**

**M.O. BRICKMOULD**  
**M.O. ADAMS/FLAT CASING**  
**ROUGH OPENING**  
**FRAME SIZE**  
**DAYLIGHT OPENING**

97 1/16" [2465]  
100 1/8" [2543]  
94 9/16" [2402]  
93 13/16" [2383]  
22 5/8" [575] (2) - 7 1/2" [190] (2)

101 1/16" [2567]  
104 1/8" [2645]  
98 9/16" [2503]  
97 13/16" [2484]  
22 5/8" [575] (2) - 9 1/2" [241] (2)

105 1/16" [2669]  
108 1/8" [2746]  
102 9/16" [2605]  
101 13/16" [2586]  
22 5/8" [602] (2) - 11 1/2" [292] (2)

84" [2134]  
85 17/32" [2172]  
82 7/8" [2105]  
82 1/8" [2086]  
68 11/16" [1745]

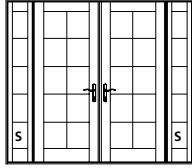

COFRT5468Q10

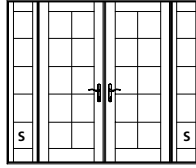

COFRT5468Q12

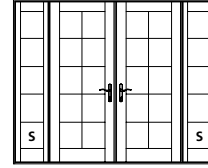

COFRT5468Q14

88" [2235]  
89 17/32" [2274]  
86 7/8" [2206]  
86 1/8" [2188]  
72 11/16" [1846]

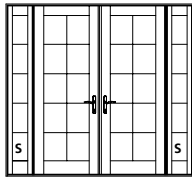

COFRT5470Q10

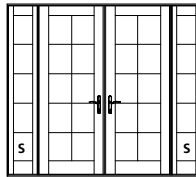

COFRT5470Q12

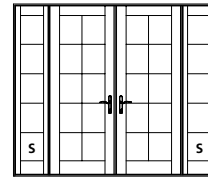

COFRT5470Q14

100" [2540]  
101 17/32" [2579]  
98 7/8" [2511]  
98 1/8" [2492]  
84 11/16" [2151]

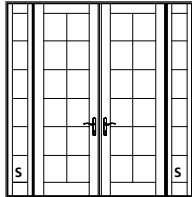

COFRT5480Q10

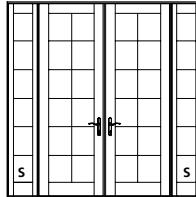

COFRT5480Q12

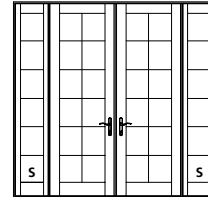

COFRT5480Q14

112" [2845]  
113 17/32" [2884]  
110 7/8" [2816]  
110 1/8" [2797]  
96 11/16" [2456]

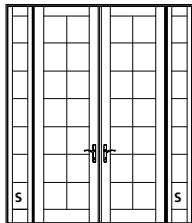

COFRT5490Q10

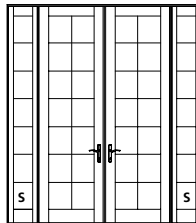

COFRT5490Q12

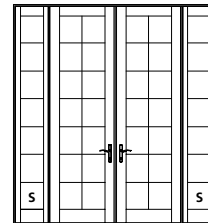

COFRT5490Q14

**ELEVATION SYMBOL LEGEND:**

**M.O.** = MASONRY OPENING  
VALUES IN ( ) ARE NUMBER OF DAYLIGHT OPENINGS PER UNIT  
VALUES IN [ ] ARE IN MILLIMETER CONVERSIONS  
**S** PANEL IS AVAILABLE AS STATIONARY ONLY.

Note: Elevations shown DO NOT have exterior trim. Subtract 1/2" (12.7) from M.O. (Masonry Opening) for Unit Size. For other Trim Options refer to the Unit Sizing, Rough Opening & Masonry Openings page.

SCALE: 1/8" = 1'



**FRENCH DOOR WITH TWO SIDELIGHTS**  
**6-0 UNITS**

**M.O. BRICKMOULD**  
**M.O. ADAMS/FLAT CASING**  
**ROUGH OPENING**  
**FRAME SIZE**  
**DAYLIGHT OPENING**

105 1/16" [2669]  
108 1/8" [2746]  
102 9/16" [2605]  
101 13/16" [2586]  
26 5/8" [676] (2) - 7 1/2" [190] (2)

109 1/16" [2770]  
112 1/8" [2848]  
106 9/16" [2707]  
105 13/16" [2688]  
26 5/8" [676] (2) - 9 1/2" [241] (2)

113 1/16" [2872]  
116 1/8" [2950]  
110 9/16" [2808]  
109 13/16" [2789]  
26 5/8" [676] (2) - 11 1/2" [292] (2)

84" [2134]  
85 17/32" [2172]  
82 7/8" [2105]  
82 1/8" [2086]  
68 11/16" [1745]

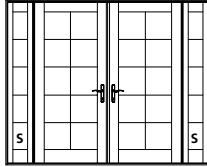

COFRT6068Q10

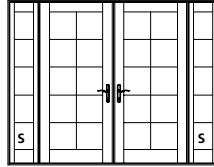

COFRT6068Q12

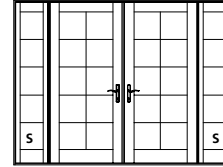

COFRT6068Q14

88" [2235]  
89 17/32" [2274]  
86 7/8" [2206]  
86 1/8" [2188]  
72 11/16" [1846]

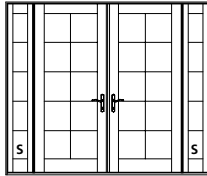

COFRT6070Q10

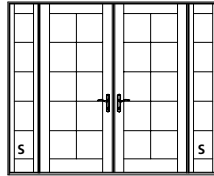

COFRT6070Q12

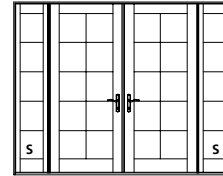

COFRT6070Q14

100" [2540]  
101 17/32" [2579]  
98 7/8" [2511]  
98 1/8" [2492]  
84 11/16" [2151]

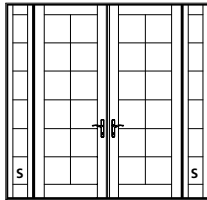

COFRT6080Q10

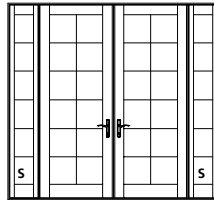

COFRT6080Q12

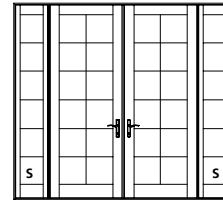

COFRT6080Q14

112" [2845]  
113 17/32" [2884]  
110 7/8" [2816]  
110 1/8" [2797]  
96 11/16" [2456]

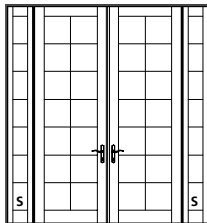

COFRT6090Q10

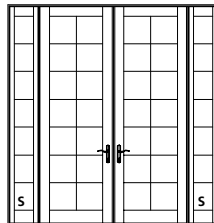

COFRT6090Q12

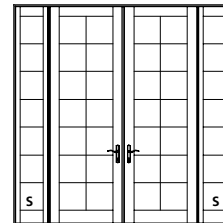

COFRT6090Q14

**ELEVATION SYMBOL LEGEND:**

**M.O.** = MASONRY OPENING  
VALUES IN ( ) ARE NUMBER OF DAYLIGHT OPENINGS PER UNIT  
VALUES IN [ ] ARE IN MILLIMETER CONVERSIONS  
**S** PANEL IS AVAILABLE AS STATIONARY ONLY.

Note: Elevations shown DO NOT have exterior trim. Subtract 1/2" (12.7) from M.O. (Masonry Opening) for Unit Size. For other Trim Options refer to the Unit Sizing, Rough Opening & Masonry Openings page.

SCALE: 1/8" = 1'

**FRENCH DOOR WITH TWO SIDELIGHTS**  
**7-0 UNITS**

**M.O. BRICKMOULD**  
**M.O. ADAMS/FLAT CASING**  
**ROUGH OPENING**  
**FRAME SIZE**  
**DAYLIGHT OPENING**

117 1/16" [2973]  
120 1/8" [3051]  
114 9/16" [2910]  
113 13/16" [2891]  
32 5/8" [829] (2) - 7 1/2" [190] (2)

121 1/16" [3075]  
124 1/8" [3153]  
118 9/16" [3011]  
117 13/16" [2992]  
32 5/8" [829] (2) - 9 1/2" [241] (2)

125 1/16" [3177]  
128 1/8" [3254]  
122 9/16" [3113]  
121 13/16" [3094]  
32 5/8" [829] (2) - 11 1/2" [292] (2)

84" [2134]  
85 17/32" [2172]  
82 7/8" [2105]  
82 1/8" [2086]  
68 11/16" [1745]

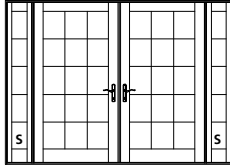

COFRT7068Q10

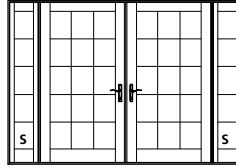

COFRT7068Q12

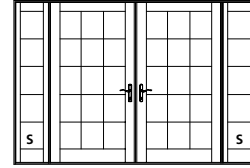

COFRT7068Q14

88" [2235]  
89 17/32" [2274]  
86 7/8" [2206]  
86 1/8" [2188]  
72 11/16" [1846]

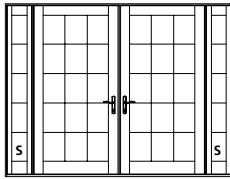

COFRT7070Q10

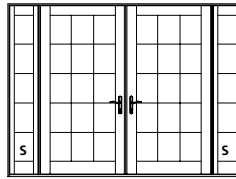

COFRT7070Q12

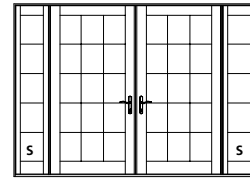

COFRT7070Q14

100" [2540]  
101 17/32" [2579]  
98 7/8" [2511]  
98 1/8" [2492]  
84 11/16" [2151]

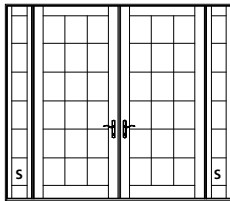

COFRT7080Q10

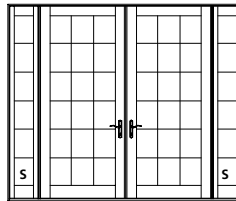

COFRT7080Q12

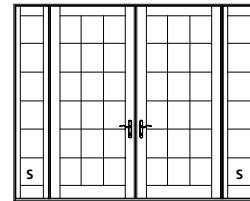

COFRT7080Q14

**ELEVATION SYMBOL LEGEND:**

**M.O.** = MASONRY OPENING  
VALUES IN ( ) ARE NUMBER OF DAYLIGHT OPENINGS PER UNIT  
VALUES IN [ ] ARE IN MILLIMETER CONVERSIONS  
**S** PANEL IS AVAILABLE AS STATIONARY ONLY.

Note: Elevations shown DO NOT have exterior trim. Subtract 1/2" (12.7) from M.O. (Masonry Opening) for Unit Size. For other Trim Options refer to the Unit Sizing, Rough Opening & Masonry Openings page.

SCALE: 1/8" = 1'

**SINGLE SASH TRANSOMS**

**M.O. BRICKMOLD**  
**M.O. ADAMS/FLAT CASING**  
**ROUGH OPENING**  
**FRAME SIZE**  
**DAYLIGHT OPENING**

27 1/4" [692]	33 1/4" [845]	39 1/4" [997]	50 7/16" [1281]	62 7/16" [1586]	74 7/16" [1891]
30 5/16" [770]	36 5/16" [922]	42 5/16" [1075]	52 15/16" [1345]	65 1/2" [1664]	77 1/2" [1969]
24 3/4" [629]	30 3/4" [781]	36 3/4" [933]	47 15/16" [1218]	59 15/16" [1522]	71 15/16" [1827]
24" [610]	30" [762]	36" [914]	47 3/16" [1199]	59 3/16" [1503]	71 3/16" [1808]
12 5/8" [321]	18 5/8" [473]	24 5/8" [625]	35 13/16" [910]	47 13/16" [1214]	59 13/16" [1519]

20 1/2" [521]  
22" [559]  
18 3/4" [476]  
18" [457]  
11 1/2" [292]



32 1/2" [826]  
34" [864]  
30 3/4" [781]  
30" [762]  
23 1/2" [597]



**M.O. BRICKMOLD**  
**M.O. ADAMS/FLAT CASING**  
**ROUGH OPENING**  
**FRAME SIZE**  
**DAYLIGHT OPENING**

17 3/8" [441]	19 3/8" [492]	21 3/8" [543]	29 1/4" [743]	35 1/4" [895]	37 1/4" [946]	41 1/4" [1048]	47 1/4" [1200]
20 7/16" [519]	22 7/16" [570]	24 7/16" [621]	32 5/16" [821]	38 5/16" [973]	40 5/16" [1024]	44 5/16" [1126]	50 5/16" [1278]
14 7/8" [378]	16 7/8" [429]	18 7/8" [479]	26 3/4" [679]	32 3/4" [832]	34 3/4" [883]	38 3/4" [984]	44 3/4" [1137]
14 1/8" [359]	16 1/8" [410]	18 1/8" [460]	26" [660]	32" [813]	34" [864]	38" [965]	44" [1118]
7 1/2" [190]	9 1/2" [241]	11 1/2" [292]	14 5/8" [371]	20 5/8" [524]	22 5/8" [575]	26 5/8" [676]	32 5/8" [829]

20 1/2" [521]  
22" [559]  
18 3/4" [476]  
18" [457]  
11 1/2" [292]



32 1/2" [826]  
34" [864]  
30 3/4" [781]  
30" [762]  
23 1/2" [597]

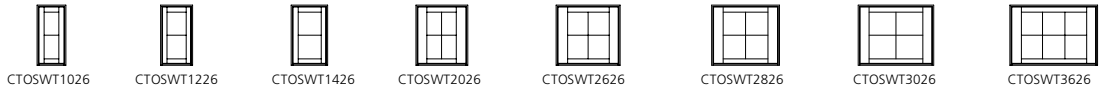

**M.O. BRICKMOLD**  
**M.O. ADAMS/FLAT CASING**  
**ROUGH OPENING**  
**FRAME SIZE**  
**DAYLIGHT OPENING**

54 7/16" [1383]	66 7/16" [1688]	70 7/16" [1789]	78 7/16" [1992]	90 7/16" [2297]
57 1/2" [1461]	69 1/2" [1765]	73 1/2" [1867]	81 1/2" [2070]	93 1/2" [2375]
51 15/16" [1319]	63 15/16" [1624]	67 15/16" [1726]	75 15/16" [1929]	87 15/16" [2234]
51 3/16" [1300]	63 3/16" [1605]	67 3/16" [1707]	75 3/16" [1910]	87 3/16" [2215]
39 13/16" [1011]	51 13/16" [1316]	55 13/16" [1418]	63 13/16" [1621]	75 13/16" [1926]

20 1/2" [521]  
22" [559]  
18 3/4" [476]  
18" [457]  
11 1/2" [292]

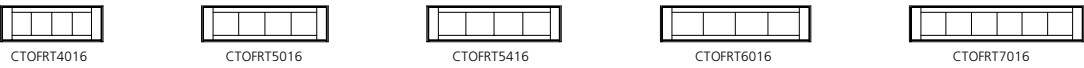

32 1/2" [826]  
34" [864]  
30 3/4" [781]  
30" [762]  
23 1/2" [597]

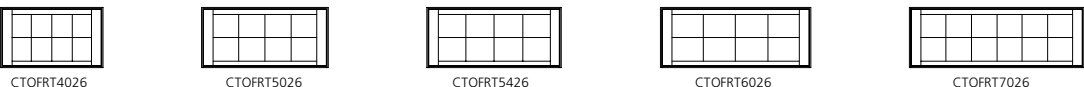

**ELEVATION SYMBOL LEGEND:**  
**M.O.** = MASONRY OPENING  
VALUES IN [ ] ARE IN MILLIMETER CONVERSIONS

Note: Elevations shown DO NOT have exterior trim. Subtract 1/2" (12.7) from M.O. (Masonry Opening) for Unit Sizes. Masonry Openings above include Sill Nose, see Transom Rail & Sill Options page for Sill Nose specifications. For other Trim Options refer to the Unit Sizing, Rough Opening & Masonry Openings page.

SCALE: 1/8" = 1'

**2-SASH TRANSOMS**

**M.O. BRICKMOULD**  
**M.O. ADAMS/FLAT CASING**  
**ROUGH OPENING**  
**FRAME SIZE**  
**DAYLIGHT OPENING**

50 7/16" [1281]  
53 1/2" [1359]  
47 15/16" [1218]  
47 3/16" [1199]  
12 5/8" [321] (2)

62 7/16" [1586]  
65 1/2" [1684]  
59 15/16" [1522]  
59 3/16" [1503]  
18 5/8" [473] (2)

74 7/16" [1891]  
77 1/2" [1969]  
71 15/16" [1827]  
71 3/16" [1808]  
24 5/8" [625] (2)

54 7/16" [1383]  
57 1/2" [1461]  
51 15/16" [1319]  
51 3/16" [1300]  
14 5/8" [371] (2)

20 1/2" [521]  
22" [559]  
18 3/4" [476]  
18" [457]  
11 1/2" [292]



CTOSWR4016



CTOSWR5016



CTOSWR6016



CTOSWT4016

32 1/2" [826]  
34" [864]  
30 3/4" [781]  
30" [762]  
23 1/2" [597]

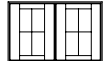

CTOSWR4026

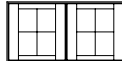

CTOSWR5026

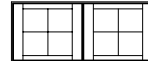

CTOSWR6026

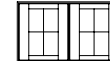

CTOSWT4026

**M.O. BRICKMOULD**  
**M.O. ADAMS/FLAT CASING**  
**ROUGH OPENING**  
**FRAME SIZE**  
**DAYLIGHT OPENING**

66 7/16" [1688]  
69 1/2" [1765]  
63 15/16" [1624]  
63 3/16" [1605]  
20 5/8" [524] (2)

70 7/16" [1789]  
73 1/2" [1867]  
67 15/16" [1726]  
67 3/16" [1707]  
22 5/8" [575] (2)

78 7/16" [1992]  
81 1/2" [2070]  
75 15/16" [1929]  
75 3/16" [1910]  
26 5/8" [676] (2)

90 7/16" [2297]  
93 1/2" [2375]  
87 15/16" [2234]  
87 3/16" [2215]  
32 5/8" [829] (2)

20 1/2" [521]  
22" [559]  
18 3/4" [476]  
18" [457]  
11 1/2" [292]



CTOSWT5016



CTOSWT5416



CTOSWT6016



CTOSWT7016

32 1/2" [826]  
34" [864]  
30 3/4" [781]  
30" [762]  
23 1/2" [597]

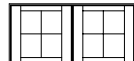

CTOSWT5026

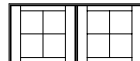

CTOSWT5426



CTOSWT6026

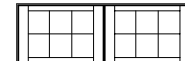

CTOSWT7026

**M.O. BRICKMOULD**  
**M.O. ADAMS/FLAT CASING**  
**ROUGH OPENING**  
**FRAME SIZE**  
**DAYLIGHT OPENING**

54 9/16" [1386]  
57 5/8" [1464]  
52 1/16" [1322]  
51 5/16" [1303]  
26 5/8" [676] - 7 1/2" [190]

56 9/16" [1437]  
59 5/8" [1514]  
54 1/16" [1373]  
53 5/16" [1354]  
26 5/8" [676] - 9 1/2" [241]

58 9/16" [1487]  
61 5/8" [1565]  
56 1/16" [1424]  
55 5/16" [1405]  
26 5/8" [676] - 11 1/2" [292]

20 1/2" [521]  
22" [559]  
18 3/4" [476]  
18" [457]  
11 1/2" [292]



CTOSWT3016B10



CTOSWT3016B12



CTOSWT3016B14

32 1/2" [826]  
34" [864]  
30 3/4" [781]  
30" [762]  
23 1/2" [597]

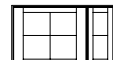

CTOSWT3026B10

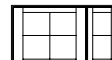

CTOSWT3026B12

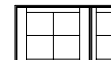

CTOSWT3026B14

**M.O. BRICKMOULD**  
**M.O. ADAMS/FLAT CASING**  
**ROUGH OPENING**  
**FRAME SIZE**  
**DAYLIGHT OPENING**

60 9/16" [1538]  
63 5/8" [1616]  
58 1/16" [1475]  
57 5/16" [1456]  
32 5/8" [829] - 7 1/2" [190]

62 9/16" [1589]  
65 5/8" [1667]  
60 1/16" [1526]  
59 5/16" [1507]  
32 5/8" [829] - 9 1/2" [241]

64 9/16" [1640]  
67 5/8" [1718]  
62 1/16" [1576]  
61 5/16" [1557]  
32 5/8" [829] - 11 1/2" [290]

20 1/2" [521]  
22" [559]  
18 3/4" [476]  
18" [457]  
11 1/2" [292]



CTOSWT3616B10



CTOSWT3616B10



CTOSWT3616B10

32 1/2" [826]  
34" [864]  
30 3/4" [781]  
30" [762]  
23 1/2" [597]

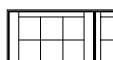

CTOSWT3626B10

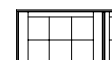

CTOSWT3626B10

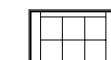

CTOSWT3626B10

**ELEVATION SYMBOL LEGEND:**

**M.O.** = MASONRY OPENING  
VALUES IN ( ) ARE NUMBER OF DAYLIGHT OPENINGS PER UNIT  
VALUES IN [ ] ARE IN MILLIMETER CONVERSIONS

Note: Elevations shown DO NOT have exterior trim. Subtract 1/2" (12.7) from M.O. (Masonry Opening) for Unit Sizes. Masonry Openings above include Sill Nose, see Transom Rail & Sill Options page for Sill Nose specifications. For other Trim Options refer to the Unit Sizing, Rough Opening & Masonry Openings page.

SCALE: 1/8" = 1'

**3-SASH TRANSOMS**

**M.O. BRICKMOULD**  
**M.O. ADAMS/FLAT CASING**  
**ROUGH OPENING**  
**FRAME SIZE**  
**DAYLIGHT OPENING**

91 5/8" [2237]  
94 11/16" [2405]  
89 1/8" [2264]  
88 3/8" [2245]  
18 5/8" [473] (3)

109 5/8" [2784]  
112 11/16" [2862]  
107 1/8" [2721]  
106 3/8" [2702]  
24 5/8" [625] (3)

97 5/8" [2480]  
100 11/16" [2557]  
95 1/8" [2416]  
94 3/8" [2397]  
20 5/8" [524] (3)

20 1/2" [521]  
22" [559]  
18 3/4" [476]  
18" [457]  
11 1/2" [292]

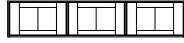

CTOSWR7616



CTOSWR9016

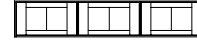

CTOSWT7616

32 1/2" [826]  
34" [864]  
30 3/4" [781]  
30" [762]  
23 1/2" [597]

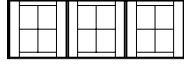

CTOSWR7626

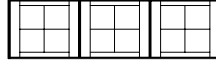

CTOSWR9026

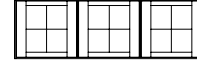

CTOSWT7626

**M.O. BRICKMOULD**  
**M.O. ADAMS/FLAT CASING**  
**ROUGH OPENING**  
**FRAME SIZE**  
**DAYLIGHT OPENING**

103 5/8" [2632]  
106 11/16" [2710]  
101 1/8" [2569]  
100 3/8" [2550]  
22 5/8" [575] (3)

115 5/8" [2937]  
118 11/16" [3015]  
113 1/8" [2873]  
112 13/16" [2854]  
26 5/8" [676] (3)

20 1/2" [521]  
22" [559]  
18 3/4" [476]  
18" [457]  
11 1/2" [292]

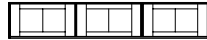

CTOSWT8016

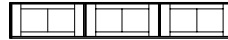

CTOSWT9016

32 1/2" [826]  
34" [864]  
30 3/4" [781]  
30" [762]  
23 1/2" [597]

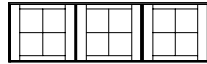

CTOSWT8026

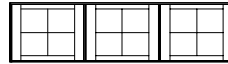

CTOSWT9026

**M.O. BRICKMOULD**  
**M.O. ADAMS/FLAT CASING**  
**ROUGH OPENING**  
**FRAME SIZE**  
**DAYLIGHT OPENING**

67 7/8" [1724]  
70 15/16" [1802]  
65 3/8" [1661]  
64 5/8" [1641]  
26 5/8" [676] - 7 1/2" [190] (2)

71 7/8" [1826]  
74 15/16" [1903]  
69 3/8" [1762]  
68 5/8" [1743]  
26 5/8" [676] - 9 1/2" [241] (2)

75 7/8" [1927]  
78 15/16" [2005]  
73 3/8" [1864]  
72 5/8" [1845]  
26 5/8" [676] - 11 1/2" [292] (2)

20 1/2" [521]  
22" [559]  
18 3/4" [476]  
18" [457]  
11 1/2" [292]

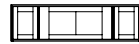

CTOSWT3016F10

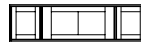

CTOSWT3016F12

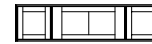

CTOSWT3016F14

32 1/2" [826]  
34" [864]  
30 3/4" [781]  
30" [762]  
23 1/2" [597]

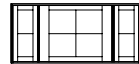

CTOSWT3026F10

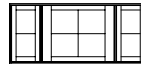

CTOSWT3026F12

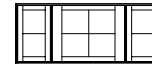

CTOSWT3026F14

**M.O. BRICKMOULD**  
**M.O. ADAMS/FLAT CASING**  
**ROUGH OPENING**  
**FRAME SIZE**  
**DAYLIGHT OPENING**

73 7/8" [1876]  
76 15/16" [1954]  
71 3/8" [1813]  
70 5/8" [1794]  
32 5/8" [829] - 7 1/2" [190] (2)

77 7/8" [1978]  
80 15/16" [2056]  
75 3/8" [1915]  
74 5/8" [1895]  
32 5/8" [829] - 9 1/2" [241] (2)

77 7/8" [1978]  
80 15/16" [2056]  
79 3/8" [2016]  
74 5/8" [1895]  
32 5/8" [829] - 11 1/2" [292] (2)

20 1/2" [521]  
22" [559]  
18 3/4" [476]  
18" [457]  
11 1/2" [292]

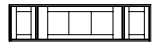

CTOSWT3616F10

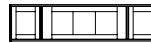

CTOSWT3616F12

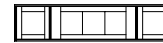

CTOSWT3616F14

32 1/2" [826]  
34" [864]  
30 3/4" [781]  
30" [762]  
23 1/2" [597]

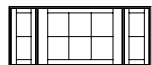

CTOSWT3626F10

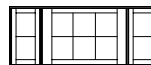

CTOSWT3626F12

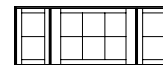

CTOSWT3626F14

**ELEVATION SYMBOL LEGEND:**  
M.O. = MASONRY OPENING  
VALUES IN ( ) ARE NUMBER OF DAYLIGHT OPENINGS PER UNIT  
VALUES IN [ ] ARE IN MILLIMETER CONVERSIONS

Note: Elevations shown DO NOT have exterior trim. Subtract 1/2" (12.7) from M.O. (Masonry Opening) for Unit Sizes. Masonry Openings above include Sill Nose, see Transom Rail & Sill Options page for Sill Nose specifications. For other Trim Options refer to the Unit Sizing, Rough Opening & Masonry Openings page.

SCALE: 1/8" = 1'

**4-SASH FRENCH TRANSOMS**

<b>M.O. BRICKMOULD</b>	96 13/16" [2459]	120 13/16" [3069]	144 13/16" [3678]
<b>M.O. ADAMS/FLAT CASING</b>	99 7/8" [2537]	123 7/8" [3146]	147 7/8" [3756]
<b>ROUGH OPENING</b>	94 5/16" [2396]	118 5/16" [3005]	142 5/16" [3615]
<b>FRAME SIZE</b>	93 9/16" [2376]	117 9/16" [2986]	141 9/16" [3596]
<b>DAYLIGHT OPENING</b>	12 5/8" [321] (2)	18 5/8" [473] (2)	24 5/8" [625] (2)

20 1/2" [521]  
22" [559]  
18 3/4" [476]  
18" [457]  
11 1/2" [292]

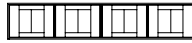

CTOFRR8016

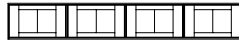

CTOFRR10016



CTOFRR12016

32 1/2" [826]  
34" [864]  
30 3/4" [781]  
30" [762]  
23 1/2" [597]

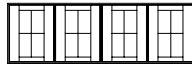

CTOFRR8026

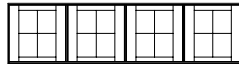

CTOFRR10026

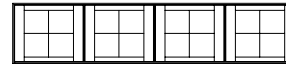

CTOFRR12026

<b>M.O. BRICKMOULD</b>	104 13/16" [2662]	128 13/16" [3272]	152 13/16" [3881]
<b>M.O. ADAMS/FLAT CASING</b>	107 7/8" [2740]	131 7/8" [3350]	155 7/8" [3989]
<b>ROUGH OPENING</b>	102 5/16" [2599]	126 5/16" [3208]	150 5/16" [3818]
<b>FRAME SIZE</b>	101 9/16" [2580]	125 9/16" [3189]	149 9/16" [3799]
<b>DAYLIGHT OPENING</b>	14 5/8" [371] (2)	20 5/8" [524] (2)	26 5/8" [676] (2)

20 1/2" [521]  
22" [559]  
18 3/4" [476]  
18" [457]  
11 1/2" [292]

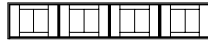

CTOFRT8016

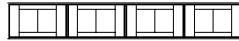

CTOFRT10016



CTOFRT12016

32 1/2" [826]  
34" [864]  
30 3/4" [781]  
30" [762]  
23 1/2" [597]

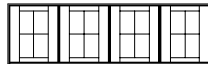

CTOFRT8026

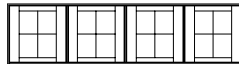

CTOFRT10026

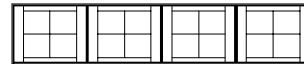

CTOFRT12026

**ELEVATION SYMBOL LEGEND:**

M.O. = MASONRY OPENING  
VALUES IN ( ) ARE NUMBER OF DAYLIGHT OPENINGS PER UNIT  
VALUES IN [ ] ARE IN MILLIMETER CONVERSIONS

Note: Elevations shown DO NOT have exterior trim. Subtract 1/2" (12.7) from M.O. (Masonry Opening) for Unit Sizes. Masonry Openings above include Sill Nose, see Transom Rail & Sill Options page for Sill Nose specifications. For other Trim Options refer to the Unit Sizing, Rough Opening & Masonry Openings page.

*Continued on next page*

SCALE: 1/8" = 1'

**FRENCH TRANSOMS WITH TWO SIDELIGHTS**

**M.O. BRICKMOUND**  
**M.O. ADAMS/FLAT CASING**  
**ROUGH OPENING**  
**FRAME SIZE**  
**DAYLIGHT OPENING**

93 1/16" [2364]  
96 1/8" [2442]  
90 9/16" [2300]  
89 13/16" [2281]  
20 5/8" [524] (2) - 7 1/2" [190] (2)

20 1/2" [521]  
22" [559]  
18 3/4" [476]  
18" [457]  
11 1/2" [292]



CTOFRT5016Q10

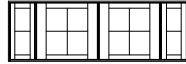

CTOFRT5026Q10

32 1/2" [826]  
34" [864]  
30 3/4" [781]  
30" [762]  
23 1/2" [597]

97 1/16" [2465]  
100 1/8" [2543]  
94 9/16" [2402]  
93 13/16" [2363]  
20 5/8" [551] (2) - 9 1/2" [241] (2)



CTOFRT5016Q12

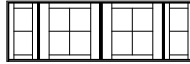

CTOFRT5026Q12

101 1/16" [2567]  
104 1/8" [2645]  
98 9/16" [2503]  
97 13/16" [2484]  
20 5/8" [524] (2) - 11 1/2" [292] (2)

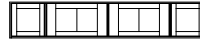

CTOFRT5016Q14

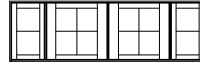

CTOFRT5026Q14

**M.O. BRICKMOUND**  
**M.O. ADAMS/FLAT CASING**  
**ROUGH OPENING**  
**FRAME SIZE**  
**DAYLIGHT OPENING**

97 1/16" [2465]  
100 1/8" [2543]  
94 9/16" [2402]  
93 13/16" [2383]  
22 5/8" [575] (2) - 7 1/2" [190] (2)

20 1/2" [521]  
22" [559]  
18 3/4" [476]  
18" [457]  
11 1/2" [292]



CTOFRT5416Q10

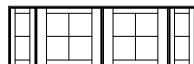

CTOFRT5426Q10

32 1/2" [826]  
34" [864]  
30 3/4" [781]  
30" [762]  
23 1/2" [597]

101 1/16" [2567]  
104 1/8" [2645]  
98 9/16" [2503]  
97 13/16" [2484]  
22 5/8" [575] (2) - 9 1/2" [241] (2)



CTOFRT5416Q12

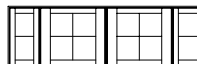

CTOFRT5426Q12

105 1/16" [2669]  
108 1/8" [2746]  
102 9/16" [2605]  
101 13/16" [2586]  
22 5/8" [575] (2) - 11 1/2" [292] (2)



CTOFRT5416Q14

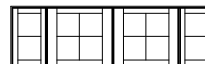

CTOFRT5426Q14

**M.O. BRICKMOUND**  
**M.O. ADAMS/FLAT CASING**  
**ROUGH OPENING**  
**FRAME SIZE**  
**DAYLIGHT OPENING**

105 1/16" [2669]  
108 1/8" [2746]  
102 9/16" [2605]  
101 13/16" [2586]  
26 5/8" [676] (2) - 7 1/2" [190] (2)

20 1/2" [521]  
22" [559]  
18 3/4" [476]  
18" [457]  
11 1/2" [292]



CTOFRT6016Q10

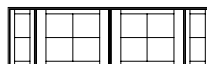

CTOFRT6026Q10

32 1/2" [826]  
34" [864]  
30 3/4" [781]  
30" [762]  
23 1/2" [597]

109 1/16" [2770]  
112 1/8" [2848]  
106 9/16" [2707]  
105 13/16" [2688]  
26 5/8" [676] (2) - 9 1/2" [241] (2)



CTOFRT6016Q12

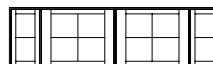

CTOFRT6026Q12

113 1/16" [2872]  
116 1/8" [2950]  
110 9/16" [2808]  
109 13/16" [2789]  
26 5/8" [676] (2) - 11 1/2" [292] (2)



CTOFRT6016Q14

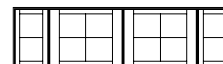

CTOFRT6026Q14

**M.O. BRICKMOUND**  
**M.O. ADAMS/FLAT CASING**  
**ROUGH OPENING**  
**FRAME SIZE**  
**DAYLIGHT OPENING**

117 1/16" [2973]  
120 1/8" [3051]  
114 9/16" [2910]  
113 13/16" [2891]  
32 5/8" [829] (2) - 7 1/2" [190] (2)

20 1/2" [521]  
22" [559]  
18 3/4" [476]  
18" [457]  
11 1/2" [292]



CTOFRT7016Q10



CTOFRT7026Q10

32 1/2" [826]  
34" [864]  
30 3/4" [781]  
30" [762]  
23 1/2" [597]

121 1/16" [3075]  
124 1/8" [3153]  
118 9/16" [3011]  
117 13/16" [2992]  
32 5/8" [829] (2) - 9 1/2" [241] (2)



CTOFRT7016Q12

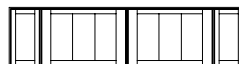

CTOFRT7026Q12

125 1/16" [3177]  
128 1/8" [3254]  
122 9/16" [3113]  
121 13/16" [3094]  
32 5/8" [829] (2) - 11 1/2" [292] (2)



CTOFRT7016Q14

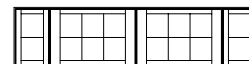

CTOFRT7026Q14

**ELEVATION SYMBOL LEGEND:**

**M.O.** = MASONRY OPENING  
VALUES IN ( ) ARE NUMBER OF DAYLIGHT OPENINGS PER UNIT  
VALUES IN [ ] ARE IN MILLIMETER CONVERSIONS

Note: Elevations shown DO NOT have exterior trim. Subtract 1/2" (12.7) from M.O. (Masonry Opening) for Unit Sizes. Masonry Openings above include Sill Nose, see Transom Rail & Sill Options page for Sill Nose specifications. For other Trim Options refer to the Unit Sizing, Rough Opening & Masonry Openings page.

SCALE: 1/8" = 1'

**1-PANEL SECTOR TOP DOORS**

**M.O. BRICKMOULD**  
**M.O. ADAMS/FLAT CASING**  
**ROUGH OPENING**  
**FRAME SIZE**  
**DAYLIGHT OPENING**

29 1/4" [743]  
32 5/16" [821]  
26 3/4" [679]  
26" [660]  
14 5/8" [371]

35 1/4" [895]  
38 5/16" [973]  
32 3/4" [832]  
32" [813]  
20 5/8" [524]

37 1/4" [946]  
40 5/16" [1024]  
34 3/4" [883]  
34" [864]  
22 5/8" [575]

41 1/4" [1048]  
44 5/16" [1126]  
38 3/4" [984]  
38" [965]  
26 5/8" [676]

47 1/4" [1200]  
50 5/16" [1278]  
44 3/4" [1137]  
44" [1118]  
32 5/8" [829]

84" [2134]  
85 17/32" [2172]  
82 7/8" [2105]  
82 1/8" [2086]  
68 11/16" [1745]

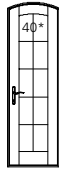

COSWTS2068

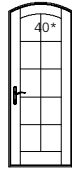

COSWTS2668

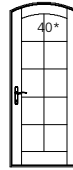

COSWTS2868

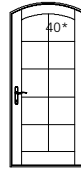

COSWTS3068

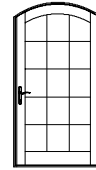

COSWTS3668

88" [2235]  
89 17/32" [2274]  
86 7/8" [2207]  
86 7/8" [2188]  
72 11/16" [1846]

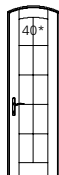

COSWTS2070

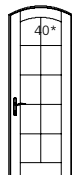

COSWTS2670

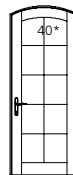

COSWTS2870

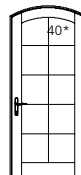

COSWTS3070

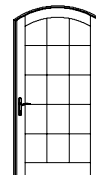

COSWTS3670

100" [2540]  
101 17/32" [2579]  
98 7/8" [2511]  
98 1/8" [2492]  
84 11/16" [2151]

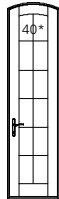

COSWTS2080

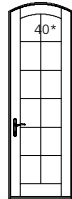

COSWTS2680

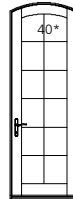

COSWTS2880

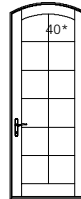

COSWTS3080

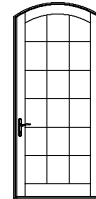

COSWTS3680

112" [2845]  
113 17/32" [2884]  
110 7/8" [2816]  
110 1/8" [2797]  
96 11/16" [2456]

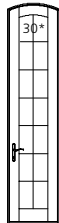

COSWTS2090

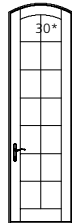

COSWTS2690

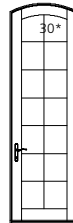

COSWTS2890

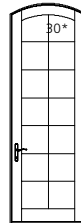

COSWTS3090

**ELEVATION SYMBOL LEGEND:**

**M.O.** = MASONRY OPENING  
VALUES IN ( ) ARE NUMBER OF DAYLIGHT OPENINGS PER UNIT  
VALUES IN [ ] ARE IN MILLIMETER CONVERSIONS  
##\* NUMBER INDICATES DESIGN PRESSURE (DP) RATING  
WITH STANDARD GLAZING. OPERATING UNITS UTILIZE  
MULTI-POINT LOCKING HARDWARE FOR DP RATINGS.

Note: Elevations shown DO NOT have exterior trim. Subtract 1/2" (12.7) from M.O. (Masonry Opening) for Unit Size. For other Trim Options refer to the Unit Sizing, Rough Opening & Masonry Openings page.

SCALE: 1/8" = 1'



**3-PANEL SECTOR TOP DOORS**

**M.O. BRICKMOULD**  
**M.O. ADAMS/FLAT CASING**  
**ROUGH OPENING**  
**FRAME SIZE**  
**DAYLIGHT OPENING**

97 5/8" [2480]  
100 11/16" [2557]  
95 1/8" [2416]  
94 3/8" [2397]  
20 5/8" [524] (3)

103 5/8" [2632]  
106 11/16" [2710]  
101 1/8" [2569]  
100 3/8" [2550]  
22 5/8" [575] (3)

115 5/8" [2937]  
118 11/16" [3015]  
113 1/8" [2873]  
112 3/8" [2854]  
26 5/8" [676] (3)

84" [2134]  
85 17/32" [2172]  
82 7/8" [2105]  
82 1/8" [2086]  
68 11/16" [1745]

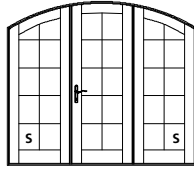

COSWTS7668

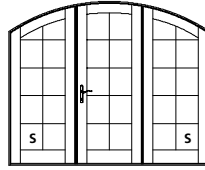

COSWTS8068

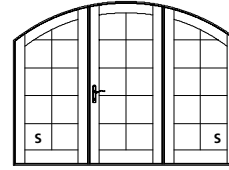

COSWTS9068

88" [2235]  
89 17/32" [2274]  
86 7/8" [2207]  
86 1/8" [2188]  
72 11/16" [1846]

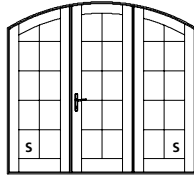

COSWTS7670

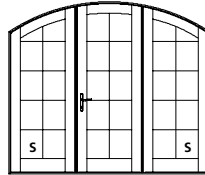

COSWTS8070

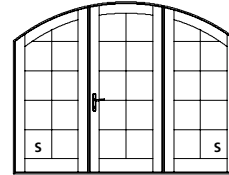

COSWTS9070

100" [2540]  
101 17/32" [2579]  
98 7/8" [2511]  
98 1/8" [2492]  
84 11/16" [2151]

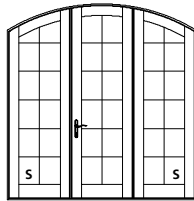

COSWTS7680

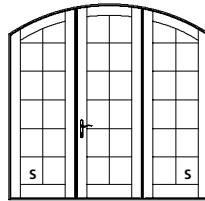

COSWTS8080

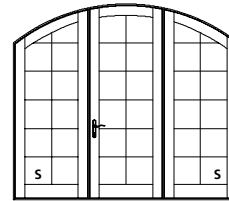

COSWTS9080

112" [2845]  
113 17/32" [2884]  
110 7/8" [2816]  
110 1/8" [2797]  
96 11/16" [2456]

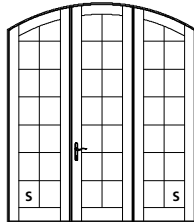

COSWTS7690

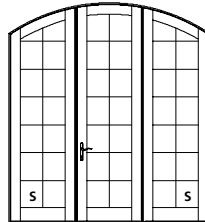

COSWTS8090

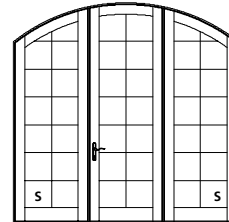

COSWTS9090

**ELEVATION SYMBOL LEGEND:**

**M.O.** = MASONRY OPENING  
VALUES IN ( ) ARE NUMBER OF DAYLIGHT OPENINGS PER UNIT  
VALUES IN [ ] ARE IN MILLIMETER CONVERSIONS  
**S** PANEL IS AVAILABLE AS STATIONARY ONLY.

Note: Elevations shown DO NOT have exterior trim. Subtract 1/2" (12.7) from M.O. (Masonry Opening) for Unit Size. For other Trim Options refer to the Unit Sizing, Rough Opening & Masonry Openings page.

SCALE: 1/8" = 1'

### 2-PANEL FRENCH SECTOR TOP DOORS

**M.O. BRICKMOULD**  
**M.O. ADAMS/FLAT CASING**  
**ROUGH OPENING**  
**FRAME SIZE**  
**DAYLIGHT OPENING**

54 7/16" [1383]  
57 1/2" [1461]  
51 15/16" [1319]  
51 3/16" [1300]  
14 5/8" [371] (2)

66 7/16" [1688]  
69 1/2" [1765]  
63 15/16" [1624]  
63 3/16" [1605]  
20 5/8" [524] (2)

70 7/16" [1789]  
73 1/2" [1867]  
67 15/16" [1726]  
67 3/16" [1707]  
22 5/8" [575] (2)

78 7/16" [1992]  
81 1/2" [2070]  
75 15/16" [1929]  
75 3/16" [1910]  
26 5/8" [676] (2)

90 7/16" [2297]  
93 1/2" [2375]  
87 15/16" [2234]  
87 3/16" [2215]  
32 5/8" [829] (2)

84" [2134]  
85 17/32" [2172]  
82 7/8" [2105]  
82 1/8" [2086]  
68 11/16" [1745]

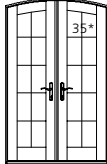

COFRTS4068

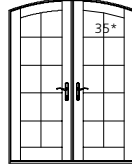

COFRTS5068

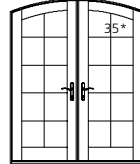

COFRTS5468

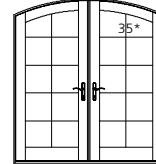

COFRTS6068

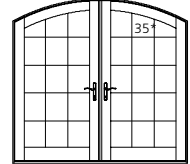

COFRTS7068

88" [2235]  
89 17/32" [2274]  
86 7/8" [2207]  
86 1/8" [2188]  
72 11/16" [1846]

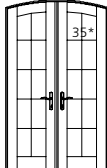

COFRTS4070

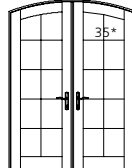

COFRTS5070

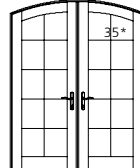

COFRTS5470

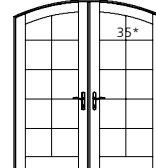

COFRTS6070

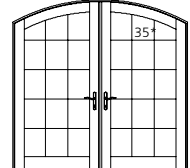

COFRTS7070

100" [2540]  
101 17/32" [2579]  
98 7/8" [2511]  
98 1/8" [2492]  
84 11/16" [2151]

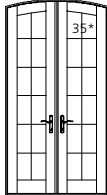

COFRTS4080

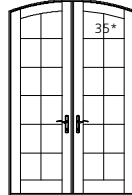

COFRTS5080

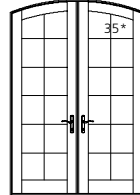

COFRTS5480

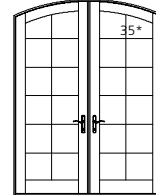

COFRTS6080

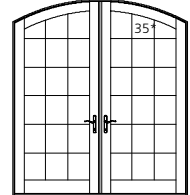

COFRTS7080

100" [2540]  
101 17/32" [2579]  
98 7/8" [2511]  
98 1/8" [2492]  
84 11/16" [2151]

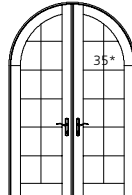

COFRTH5080

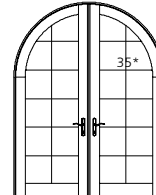

COFRTH6080

112" [2845]  
113 17/32" [2884]  
110 7/8" [2816]  
110 1/8" [2797]  
96 11/16" [2456]

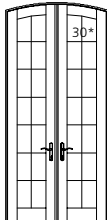

COFRTS4090

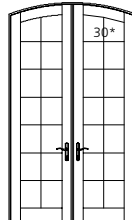

COFRTS5090

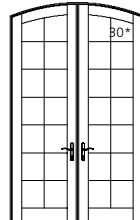

COFRTS5490

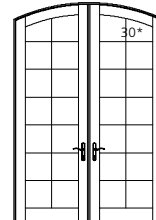

COFRTS6090

112" [2845]  
113 17/32" [2884]  
110 7/8" [2816]  
110 1/8" [2797]  
96 11/16" [2456]

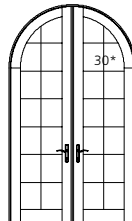

COFRTH5090

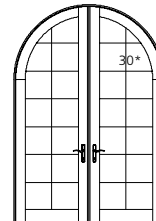

COFRTH6090

**ELEVATION SYMBOL LEGEND:**

**M.O.** = MASONRY OPENING  
VALUES IN ( ) ARE NUMBER OF DAYLIGHT OPENINGS PER UNIT  
VALUES IN [ ] ARE IN MILLIMETER CONVERSIONS  
##\* NUMBER INDICATES DESIGN PRESSURE (DP) RATING  
WITH STANDARD GLAZING. OPERATING UNITS UTILIZE  
MULTI-POINT LOCKING HARDWARE FOR DP RATINGS.

Note: Elevations shown DO NOT have exterior trim. Subtract 1/2" (12.7) from M.O. (Masonry Opening) for Unit Size. For other Trim Options refer to the Unit Sizing, Rough Opening & Masonry Openings page.

SCALE: 1/8" = 1'

**4-PANEL FRENCH SECTOR TOP DOORS**

**M.O. BRICKMOUND**  
**M.O. ADAMS/FLAT CASING**  
**ROUGH OPENING**  
**FRAME SIZE**  
**DAYLIGHT OPENING**

104 13/16" [2662]  
107 7/8" [2740]  
102 5/16" [2599]  
101 9/16" [2580]  
14 5/8" [371] (4)

128 13/16" [3272]  
131 7/8" [3350]  
126 5/16" [3208]  
125 9/16" [3189]  
20 5/8" [524] (4)

84" [2134]  
85 17/32" [2172]  
82 7/8" [2105]  
82 1/8" [2086]  
68 11/16" [1745]

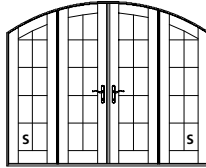

COFRTS8068

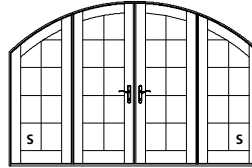

COFRTS10068

88" [2235]  
89 17/32" [2274]  
86 7/8" [2207]  
86 1/8" [2188]  
72 11/16" [1846]

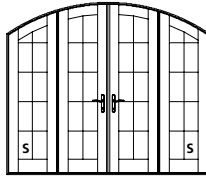

COFRTS8070

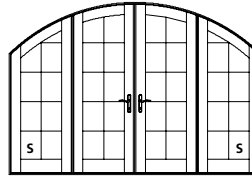

COFRTS10070

100" [2540]  
101 17/32" [2579]  
98 7/8" [2511]  
98 1/8" [2492]  
84 11/16" [2151]

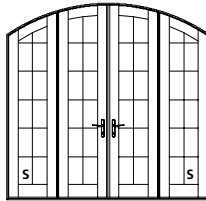

COFRTS8080

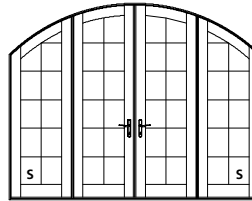

COFRTS10080

112" [2845]  
113 17/32" [2884]  
110 7/8" [2816]  
110 1/8" [2797]  
96 11/16" [2456]

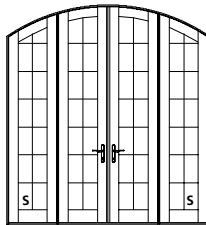

COFRTS8090

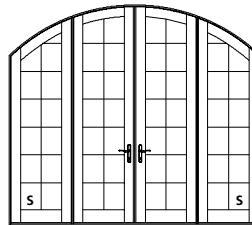

COFRTS10090

**ELEVATION SYMBOL LEGEND:**

**M.O.** = MASONRY OPENING  
VALUES IN ( ) ARE NUMBER OF DAYLIGHT OPENINGS PER UNIT  
VALUES IN [ ] ARE IN MILLIMETER CONVERSIONS  
**S** PANEL IS AVAILABLE AS STATIONARY ONLY.

Note: Elevations shown DO NOT have exterior trim. Subtract 1/2" (12.7) from M.O. (Masonry Opening) for Unit Size. For other Trim Options refer to the Unit Sizing, Rough Opening & Masonry Openings page.

SCALE: 1/8" = 1'

**FRENCH SECTOR TOP DOORS WITH TWO SIDELIGHTS**  
**5-0 UNITS**

**M.O. BRICKMOULD**  
**M.O. ADAMS/FLAT CASING**  
**ROUGH OPENING**  
**FRAME SIZE**  
**DAYLIGHT OPENING**

93 1/16" [2364]  
96 1/8" [2442]  
90 9/16" [2300]  
89 13/16" [2281]  
20 5/8" [524] (2) - 7 1/2" [190] (2)

97 1/16" [2465]  
100 1/8" [2543]  
94 9/16" [2402]  
93 13/16" [2383]  
20 5/8" [524] (2) - 9 1/2" [241] (2)

101 1/16" [2567]  
104 1/8" [2645]  
98 9/16" [2503]  
97 13/16" [2484]  
20 5/8" [524] (2) - 11 1/2" [292] (2)

84" [2134]  
85 17/32" [2172]  
82 7/8" [2105]  
82 1/8" [2086]  
68 11/16" [1745]

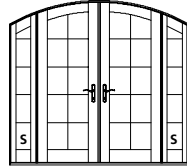

COFRTS5068Q10

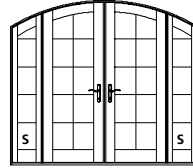

COFRTS5068Q12

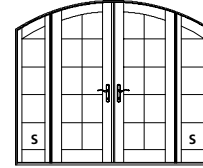

COFRTS5068Q14

88" [2235]  
89 17/32" [2274]  
86 7/8" [2207]  
86 1/8" [2188]  
72 11/16" [1846]

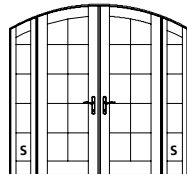

COFRTS5070Q10

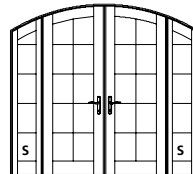

COFRTS5070Q12

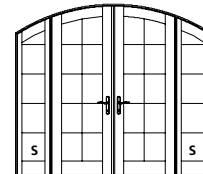

COFRTS5070Q14

100" [2540]  
101 17/32" [2579]  
98 7/8" [2511]  
98 1/8" [2492]  
84 11/16" [2151]

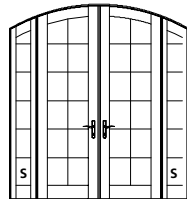

COFRTS5080Q10

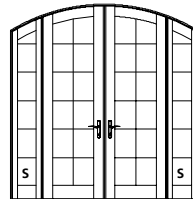

COFRTS5080Q12

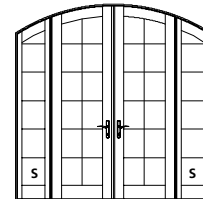

COFRTS5080Q14

112" [2845]  
113 17/32" [2884]  
110 7/8" [2816]  
110 1/8" [2797]  
96 11/16" [2456]

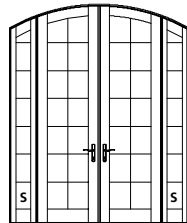

COFRTS5090Q10

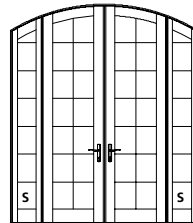

COFRTS5090Q12

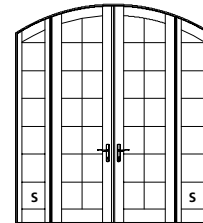

COFRTS5090Q14

**ELEVATION SYMBOL LEGEND:**

**M.O.** = MASONRY OPENING  
VALUES IN ( ) ARE NUMBER OF DAYLIGHT OPENINGS PER UNIT  
VALUES IN [ ] ARE IN MILLIMETER CONVERSIONS  
**S** PANEL IS AVAILABLE AS STATIONARY ONLY.

Note: Elevations shown DO NOT have exterior trim. Subtract 1/2" (12.7) from M.O. (Masonry Opening) for Unit Size. For other Trim Options refer to the Unit Sizing, Rough Opening & Masonry Openings page.

SCALE: 1/8" = 1'

**FRENCH SECTOR TOP DOORS WITH TWO SIDELIGHTS**  
**5-4 UNITS**

<b>M.O. BRICKMOULD</b>	97 1/16" [2465]	101 1/16" [2567]	105 1/16" [2669]
<b>M.O. ADAMS/FLAT CASING</b>	100 1/8" [2543]	104 1/8" [2645]	108 1/8" [2746]
<b>ROUGH OPENING</b>	94 9/16" [2402]	98 9/16" [2503]	102 9/16" [2605]
<b>FRAME SIZE</b>	93 13/16" [2383]	97 13/16" [2484]	101 13/16" [2586]
<b>DAYLIGHT OPENING</b>	22 5/8" [575] (2) - 7 1/2" [190] (2)	22 5/8" [575] (2) - 9 1/2" [241] (2)	22 5/8" [575] (2) - 11 1/2" [292] (2)

84" [2134]  
85 17/32" [2172]  
82 7/8" [2105]  
82 1/8" [2086]  
68 11/16" [1745]

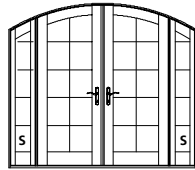

COFRTS5468Q10

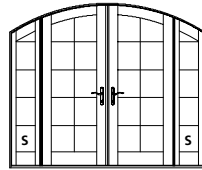

COFRTS5468Q12

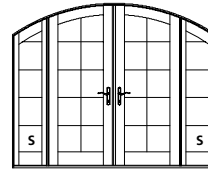

COFRTS5468Q14

88" [2235]  
89 17/32" [2274]  
86 7/8" [2207]  
86 1/8" [2188]  
72 11/16" [1846]

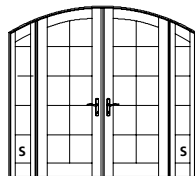

COFRTS5470Q10

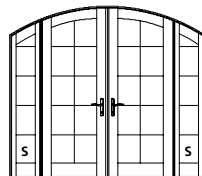

COFRTS5470Q12

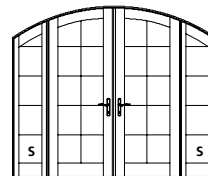

COFRTS5470Q14

100" [2540]  
101 17/32" [2579]  
98 7/8" [2511]  
98 1/8" [2492]  
84 11/16" [2151]

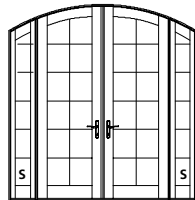

COFRTS5480Q10

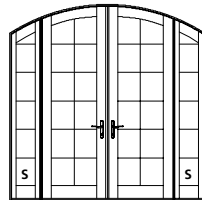

COFRTS5480Q12

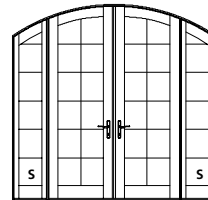

COFRTS5480Q14

112" [2845]  
113 17/32" [2884]  
110 7/8" [2816]  
110 1/8" [2797]  
96 11/16" [2456]

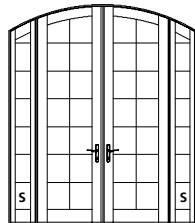

COFRTS5490Q10

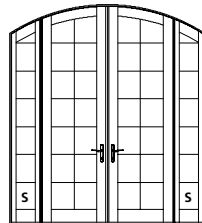

COFRTS5490Q12

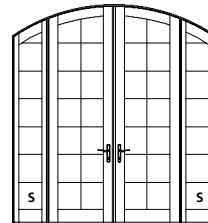

COFRTS5490Q14

**ELEVATION SYMBOL LEGEND:**  
M.O. = MASONRY OPENING  
VALUES IN ( ) ARE NUMBER OF DAYLIGHT OPENINGS PER UNIT  
VALUES IN [ ] ARE IN MILLIMETER CONVERSIONS  
S = PANEL IS AVAILABLE AS STATIONARY ONLY.

Note: Elevations shown DO NOT have exterior trim. Subtract 1/2" (12.7) from M.O. (Masonry Opening) for Unit Size. For other Trim Options refer to the Unit Sizing, Rough Opening & Masonry Openings page.

SCALE: 1/8" = 1'

**FRENCH SECTOR TOP DOORS WITH TWO SIDELIGHTS**  
**6-0 UNITS**

**M.O. BRICKMOULD**  
**M.O. ADAMS/FLAT CASING**  
**ROUGH OPENING**  
**FRAME SIZE**  
**DAYLIGHT OPENING**

105 1/16" [2669]  
108 1/8" [2746]  
102 9/16" [2605]  
101 13/16" [2586]  
26 5/8" [676] (2) - 7 1/2" [190] (2)

109 1/16" [2770]  
112 1/8" [2848]  
106 9/16" [2707]  
105 13/16" [2688]  
26 5/8" [676] (2) - 9 1/2" [241] (2)

113 1/16" [2872]  
116 1/8" [2950]  
110 9/16" [2808]  
109 13/16" [2789]  
26 5/8" [676] (2) - 11 1/2" [292] (2)

84" [2134]  
85 17/32" [2172]  
82 7/8" [2105]  
82 1/8" [2086]  
68 11/16" [1745]

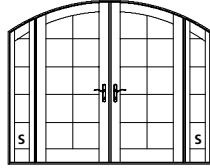

COFRTS6068Q10

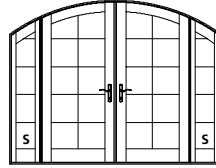

COFRTS6068Q12

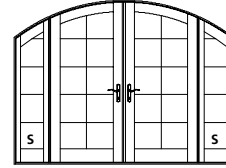

COFRTS6068Q14

88" [2235]  
89 17/32" [2274]  
86 7/8" [2207]  
86 1/8" [2188]  
72 11/16" [1873]

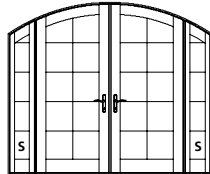

COFRTS6070Q10

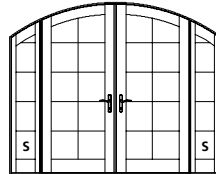

COFRTS6070Q12

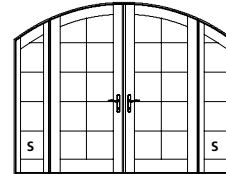

COFRTS6070Q14

100" [2540]  
101 17/32" [2579]  
98 7/8" [2511]  
98 1/8" [2492]  
84 11/16" [2151]

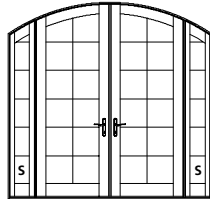

COFRTS6080Q10

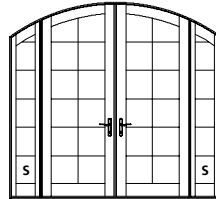

COFRTS6080Q12

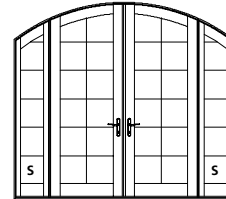

COFRTS6080Q14

112" [2845]  
113 17/32" [2884]  
110 7/8" [2816]  
110 1/8" [2797]  
96 11/16" [2456]

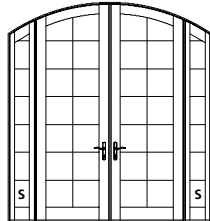

COFRTS6090Q10

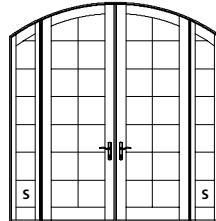

COFRTS6090Q12

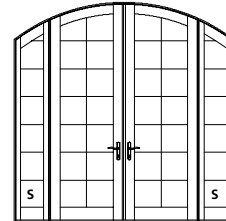

COFRTS6090Q14

**ELEVATION SYMBOL LEGEND:**

**M.O.** = MASONRY OPENING  
VALUES IN ( ) ARE NUMBER OF DAYLIGHT OPENINGS PER UNIT  
VALUES IN [ ] ARE IN MILLIMETER CONVERSIONS  
**S** PANEL IS AVAILABLE AS STATIONARY ONLY.

Note: Elevations shown DO NOT have exterior trim. Subtract 1/2" (12.7) from M.O. (Masonry Opening) for Unit Size. For other Trim Options refer to the Unit Sizing, Rough Opening & Masonry Openings page.

SCALE: 1/8" = 1'

**FRENCH SECTOR TOP DOORS WITH TWO SIDELIGHTS**  
**7-0 UNITS**

**M.O. BRICKMOULD**  
**M.O. ADAMS/FLAT CASING**  
**ROUGH OPENING**  
**FRAME SIZE**  
**DAYLIGHT OPENING**

117 1/16" [2973]  
120 1/8" [3051]  
114 9/16" [2910]  
113 13/16" [2891]  
32 5/8" [829] (2) - 7 1/2" [190] (2)

121 1/16" [3075]  
124 1/8" [3153]  
118 9/16" [3011]  
117 13/16" [2992]  
32 5/8" [829] (2) - 9 1/2" [241] (2)

125 1/16" [3177]  
128 1/8" [3254]  
122 9/16" [3113]  
121 13/16" [3094]  
32 5/8" [829] (2) - 11 1/2" [292] (2)

84" [2134]  
85 17/32" [2172]  
82 7/8" [2105]  
82 1/8" [2086]  
68 11/16" [1745]

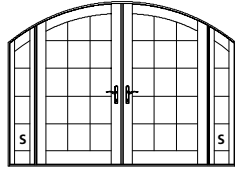

COFRTS7068Q10

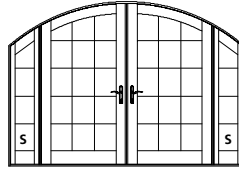

COFRTS7068Q12

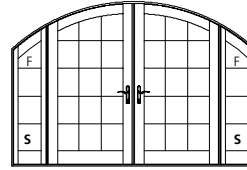

COFRTS7068Q14

88" [2235]  
89 17/32" [2274]  
86 7/8" [2207]  
86 1/8" [2188]  
72 11/16" [1846]

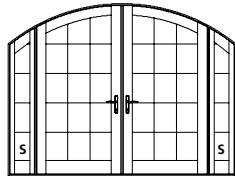

COFRTS7070Q10

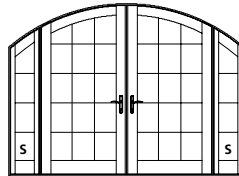

COFRTS7070Q12

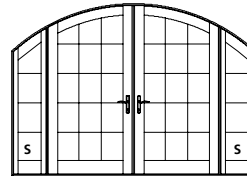

COFRTS7070Q14

100" [2540]  
101 17/32" [2579]  
98 7/8" [2511]  
98 1/8" [2492]  
84 11/16" [2151]

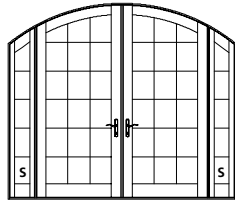

COFRTS7080Q10

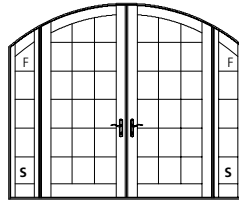

COFRTS7080Q12

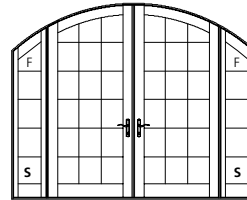

COFRTS7080Q14

**ELEVATION SYMBOL LEGEND:**

**M.O.** = MASONRY OPENING  
VALUES IN ( ) ARE NUMBER OF DAYLIGHT OPENINGS PER UNIT  
VALUES IN [ ] ARE IN MILLIMETER CONVERSIONS  
**S** PANEL IS AVAILABLE AS STATIONARY ONLY.

Note: Elevations shown DO NOT have exterior trim. Subtract 1/2" (12.7) from M.O. (Masonry Opening) for Unit Size. For other Trim Options refer to the Unit Sizing, Rough Opening & Masonry Openings page.

**SECTOR TOP TRANSOM UNITS**

**M.O. BRICKMOULD**  
**M.O. ADAMS/FLAT CASING**  
**ROUGH OPENING**  
**FRAME SIZE**  
**DAYLIGHT OPENING**

29 1/4" [743]  
32 5/16" [821]  
26 3/4" [679]  
26" [660]  
14 5/8" [371]

35 1/4" [895]  
38 5/16" [973]  
32 3/4" [832]  
32" [813]  
20 5/8" [524]

37 1/4" [946]  
40 5/16" [1024]  
34 3/4" [883]  
34" [864]  
22 5/8" [575]

41 1/4" [1048]  
44 5/16" [1126]  
38 3/4" [984]  
38" [965]  
26 5/8" [676]

22 1/2" [572]  
24" [607]  
20 3/4" [527]  
20" [508]  
13 1/2" [343]



CTOSWTS2018



CTOSWTS2618



CTOSWTS2818



CTOSWTS3018

32 1/2" [826]  
34" [864]  
30 3/4" [781]  
30" [762]  
23 1/2" [597]



CTOSWTS2026



CTOSWTS2626



CTOSWTS2826



CTOSWTS3026

**M.O. BRICKMOULD**  
**M.O. ADAMS/FLAT CASING**  
**ROUGH OPENING**  
**FRAME SIZE**  
**DAYLIGHT OPENING**

54 7/16" [1383]  
57 1/2" [1461]  
51 15/16" [1319]  
51 3/16" [1300]  
39 13/16" [1011]

66 7/16" [1688]  
69 1/2" [1765]  
63 15/16" [1623]  
63 3/16" [1605]  
51 13/16" [1316]

70 7/16" [1789]  
73 1/2" [1867]  
67 15/16" [1726]  
67 3/16" [1707]  
55 13/16" [1418]

78 7/16" [1992]  
81 1/2" [2070]  
75 15/16" [1929]  
75 3/16" [1910]  
63 13/16" [1621]

22 1/2" [572]  
24" [607]  
20 3/4" [527]  
20" [508]  
13 1/2" [343]



CTOFRTS4018



CTOFRTS5018



CTOFRTS5418



CTOFRTS6018

32 1/2" [826]  
34" [864]  
30 3/4" [781]  
30" [762]  
23 1/2" [597]

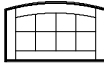

CTOFRTS4018

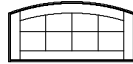

CTOFRTS5018

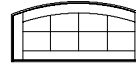

CTOFRTS5418

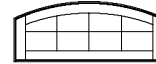

CTOFRTS6018

**ELEVATION SYMBOL LEGEND:**

**M.O.** = MASONRY OPENING  
VALUES IN [ ] ARE IN MILLIMETER CONVERSIONS

Note: Elevations shown DO NOT have exterior trim. Subtract 1/2" (12.7) from M.O. (Masonry Opening) for Unit Sizes. Masonry Openings above include Sill Nose, see Transom Rail & Sill Options page for Sill Nose specifications. For other Trim Options refer to the Unit Sizing, Rough Opening & Masonry Openings page.



**GLAZING OPTIONS**

**INTERIOR GLAZED**  
INSULATED 3/4" [19] GLASS

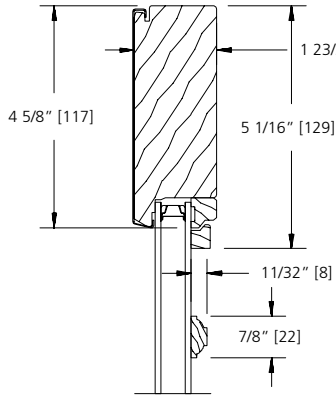

**7/8" FULL SURROUND**

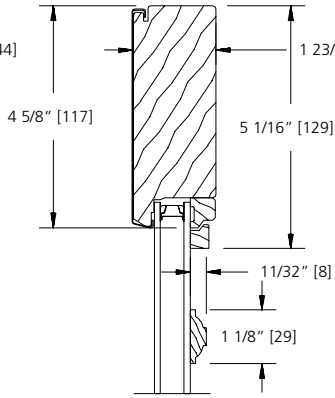

**1 1/8" FULL SURROUND**

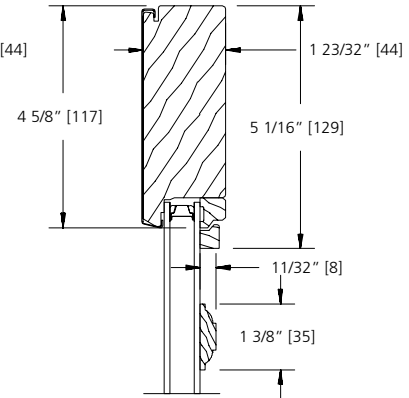

**1 3/8" FULL SURROUND**

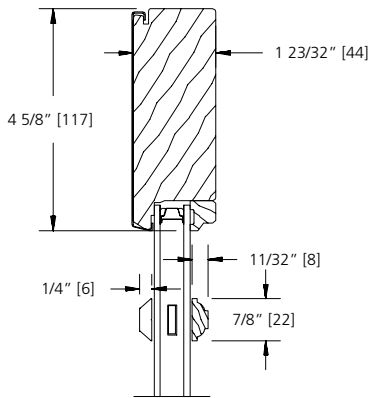

**7/8" SDL BAR  
(PUTTY LINE)**

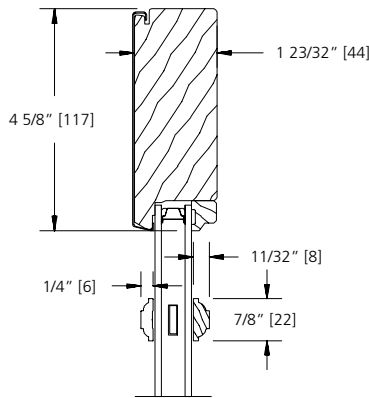

**7/8" SDL BAR  
(BEAD STOP)**

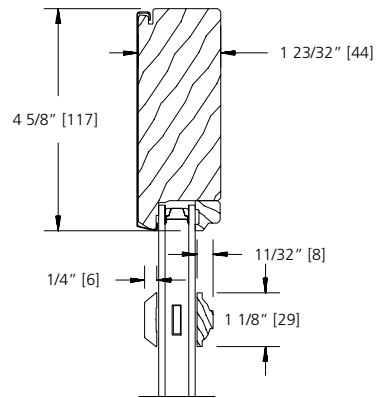

**1 1/8" SDL BAR  
(PUTTY LINE)**

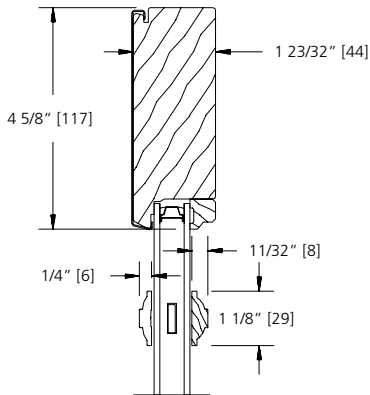

**1 1/8" SDL BAR  
(BEAD STOP)**

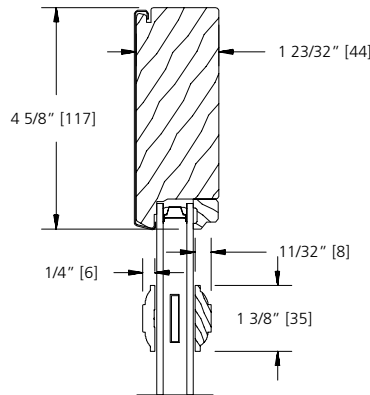

**1 3/8" SDL BAR  
(BEAD STOP)**

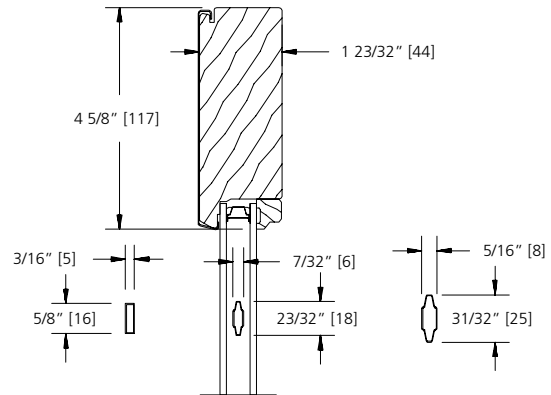

**5/8" FLAT GBG**

**23/32" CONTOUR GBG**

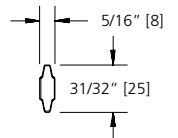

**1" CONTOUR GBG**

SCALE: 3" = 1'

**GLAZING OPTIONS**

**INTERIOR GLAZED**  
SINGLE 1/8" [3] GLASS

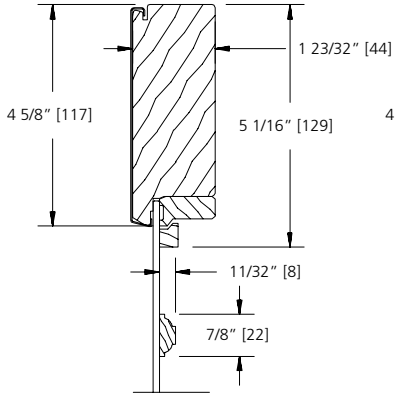

**7/8" FULL SURROUND**

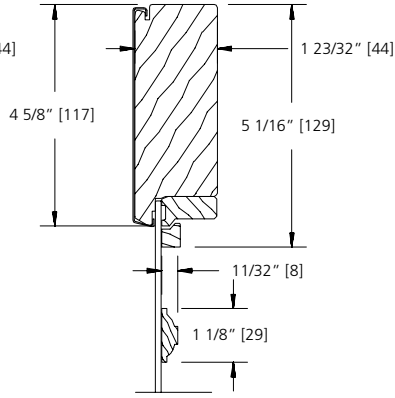

**1 1/8" FULL SURROUND**

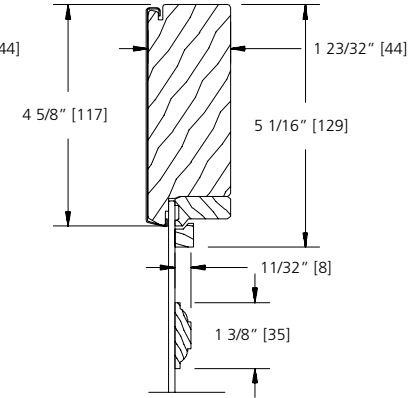

**1 3/8" FULL SURROUND**

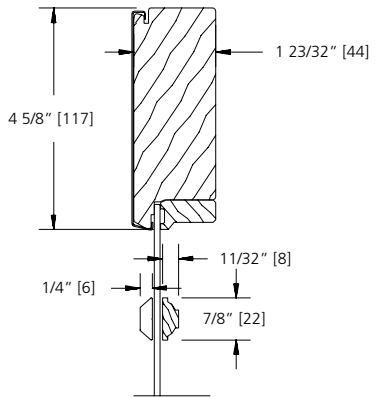

**7/8" SDL BAR  
(PUTTY LINE)**

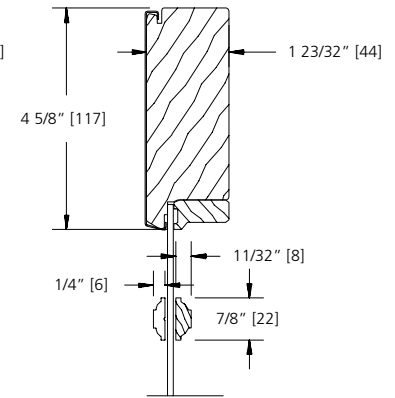

**7/8" SDL BAR  
(BEAD STOP)**

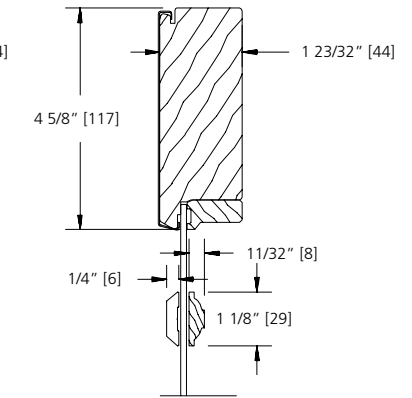

**1 1/8" SDL BAR  
(PUTTY LINE)**

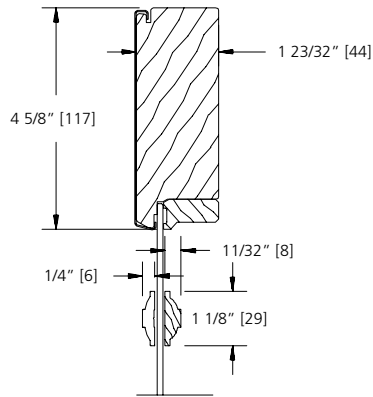

**1 1/8" SDL BAR  
(BEAD STOP)**

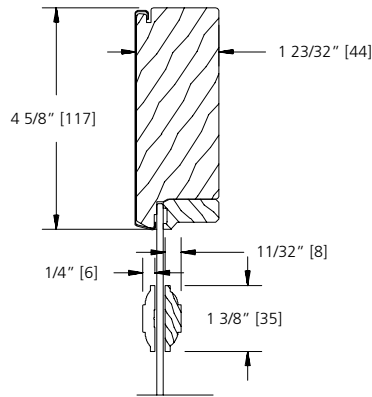

**1 3/8" SDL BAR  
(BEAD STOP)**

SCALE: 3" = 1'

**GLAZING OPTIONS**

**INTERIOR GLAZED**  
IMPACT RESISTANT GLASS

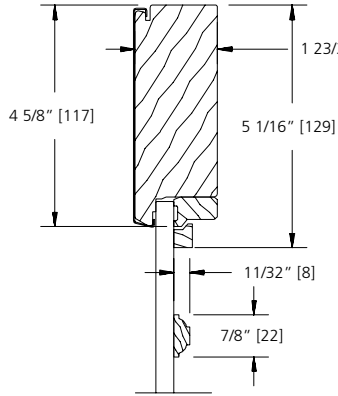

**7/8" FULL SURROUND**

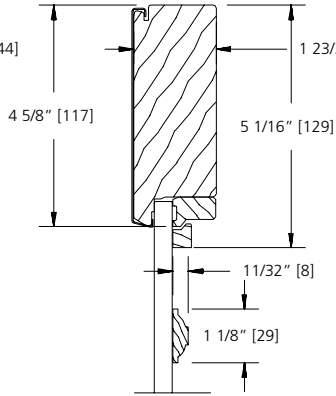

**1 1/8" FULL SURROUND**

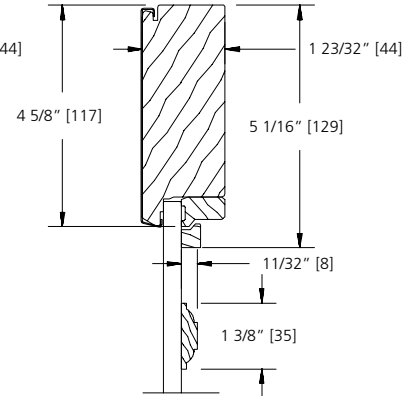

**1 3/8" FULL SURROUND**

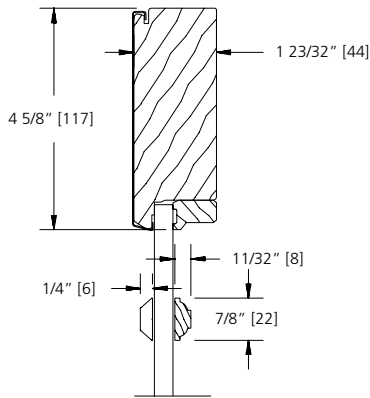

**7/8" SDL BAR  
(PUTTY LINE)**

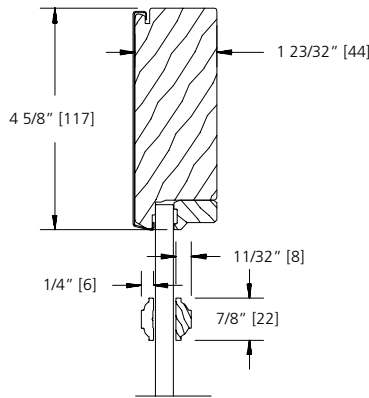

**7/8" SDL BAR  
(BEAD STOP)**

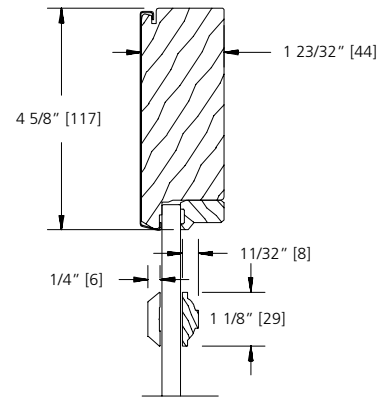

**1 1/8" SDL BAR  
(PUTTY LINE)**

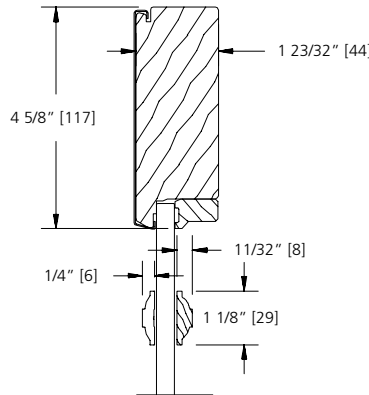

**1 1/8" SDL BAR  
(BEAD STOP)**

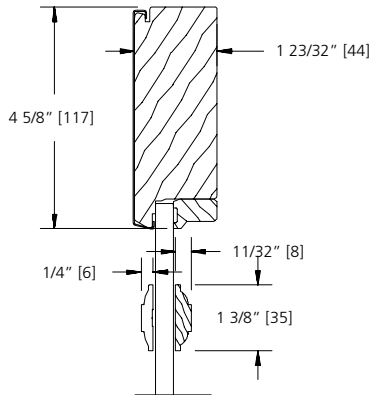

**1 3/8" SDL BAR  
(BEAD STOP)**

SCALE: 3" = 1'

**TRIM OPTIONS**

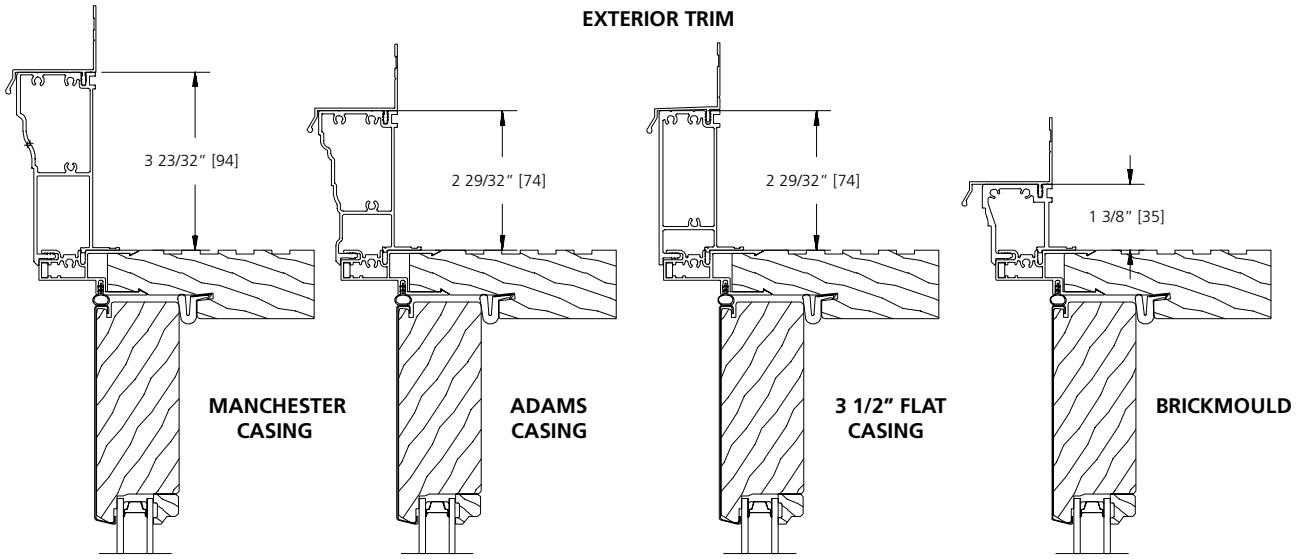

NOTE: 11/16" FOLDING NAILING FLANGE WILL BE USED ON SIDE JAMBS AND TRANSOM SILLS WITH ALL STANDARD TRIM OPTIONS

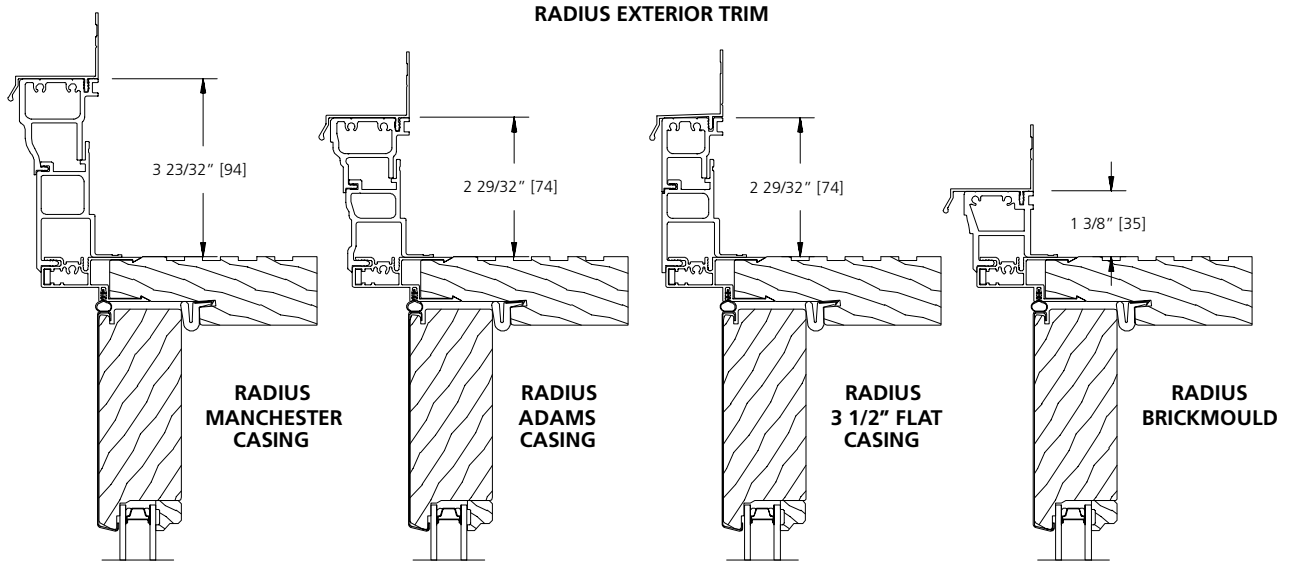

**NAILING FIN OPTIONS**

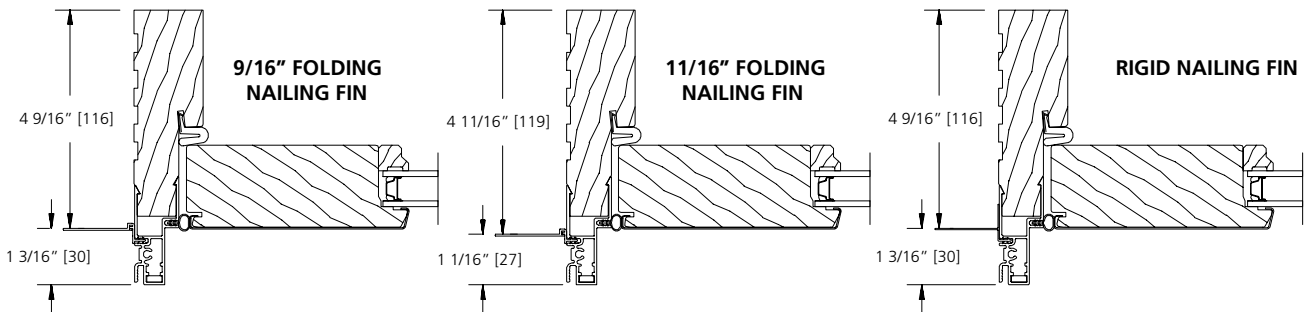

NOTE: 11/16" FOLDING NAILING FLANGE WILL BE USED ON SIDE JAMBS AND TRANSOM SILLS WITH ALL STANDARD TRIM OPTIONS. ON UNITS WITH 11/16" FOLDING NAILING FLANGE AND EXTERIOR TRIM, THE 11/16" DRIPCAP IS USED.

SCALE: 3" = 1'

**RAIL, PANEL & SILL OPTIONS**

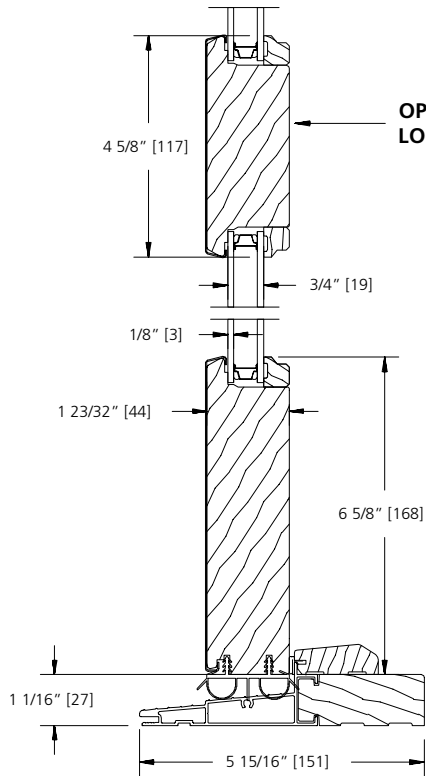

**STANDARD 6 5/8" BOTTOM RAIL**  
**STANDARD SILL (4 9/16" & 6 9/16" JAMB)**

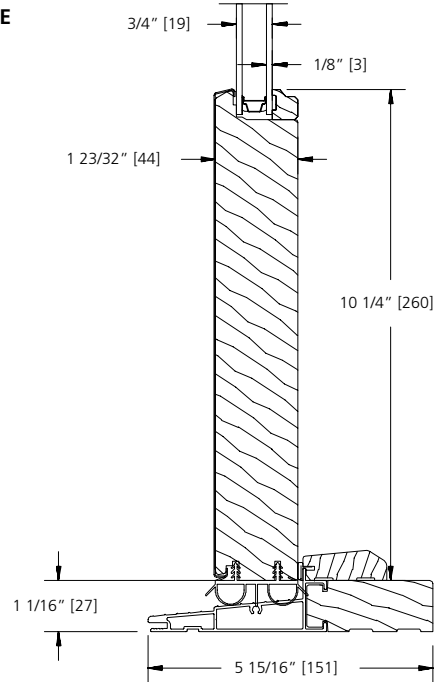

**OPTIONAL 10 1/4" BOTTOM RAIL**  
**STANDARD SILL (4 9/16" & 6 9/16" JAMB)**

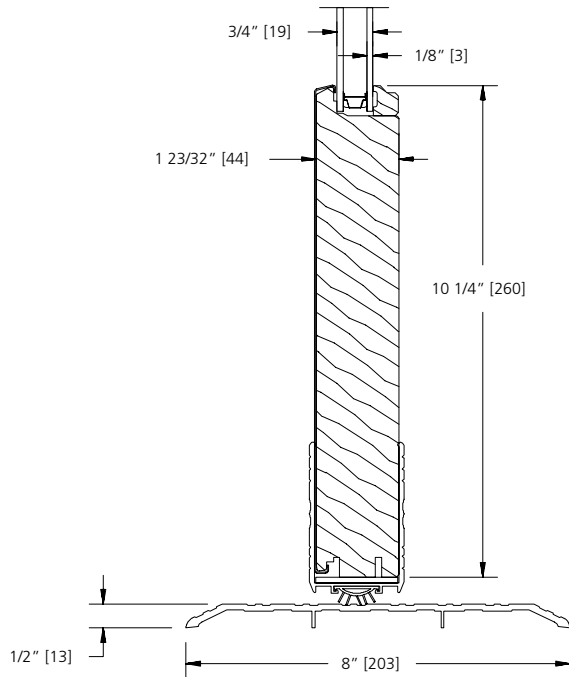

**OPTIONAL 10 1/4" BOTTOM RAIL**  
**HANDICAP SILL (4 9/16" JAMB)**

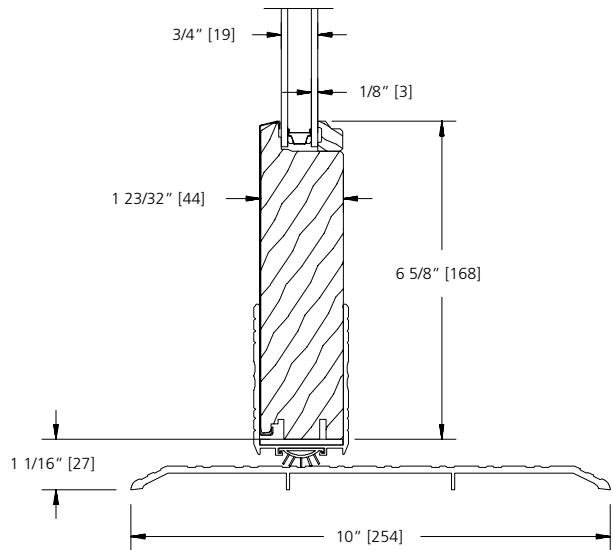

**STANDARD 6 5/8" BOTTOM RAIL**  
**HANDICAP SILL (6 9/16" JAMB)**

SCALE: 3" = 1'

**RAIL, PANEL & SILL OPTIONS**  
**TRANSOM**

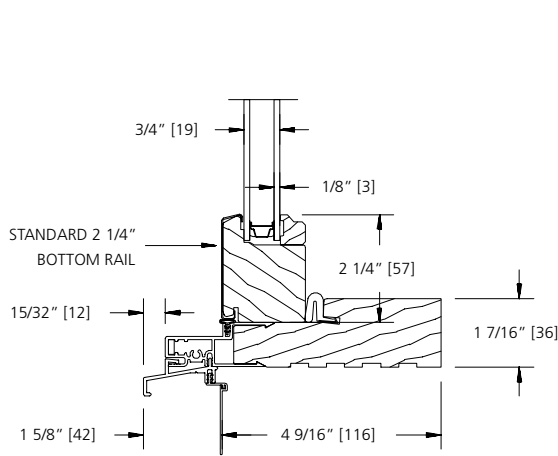

**TRANSOM**  
**SILL NOSE**  
**(4 9/16" JAMB)**

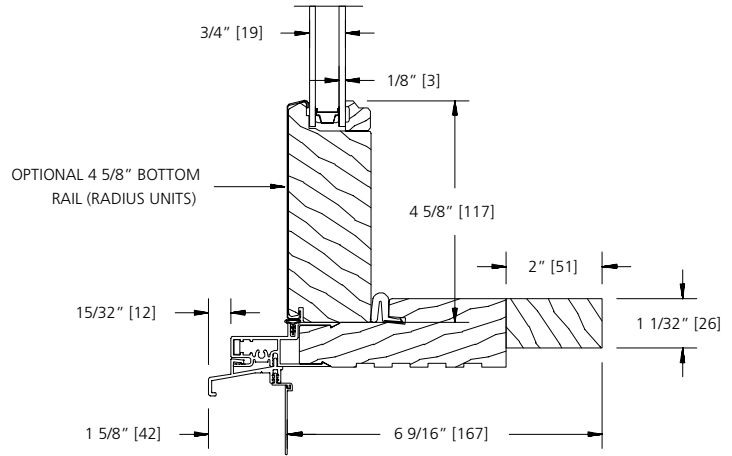

**TRANSOM**  
**SILL NOSE**  
**(6 9/16" JAMB)**

NOTE: SILL NOSE CAN BE USED WITH ALL STANDARD TRIM OPTIONS.

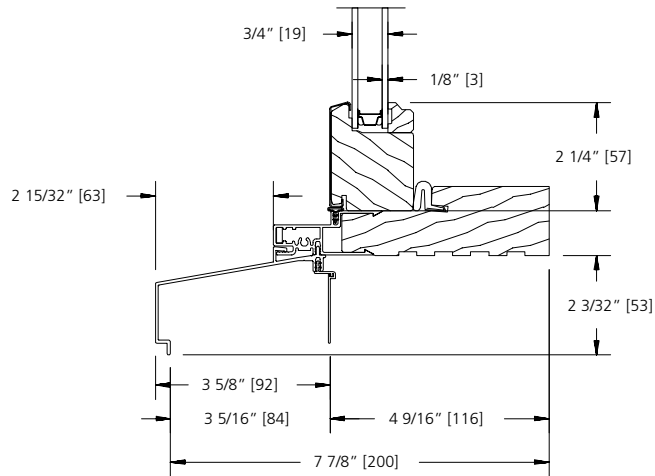

**TRANSOM**  
**EXTENDED SILL NOSE**  
**(4 9/16" JAMB)**

SCALE: 3" = 1'

**RAIL, PANEL & SILL OPTIONS**

**STANDARD RAISED PANEL OPTIONS**

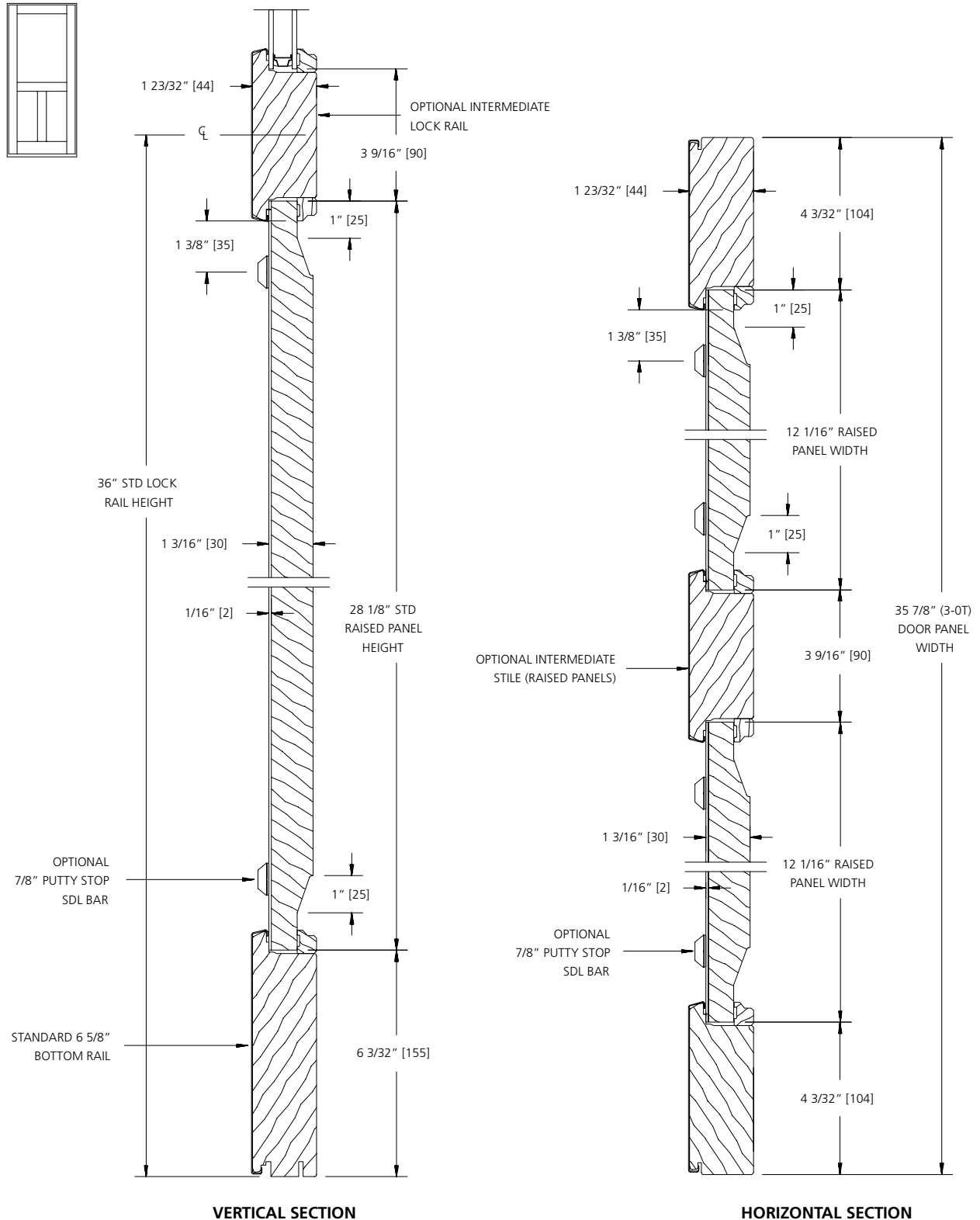

SCALE: 3" = 1'

**RAIL, PANEL & SILL OPTIONS**

**OPTIONAL RAISED PANEL OPTIONS**

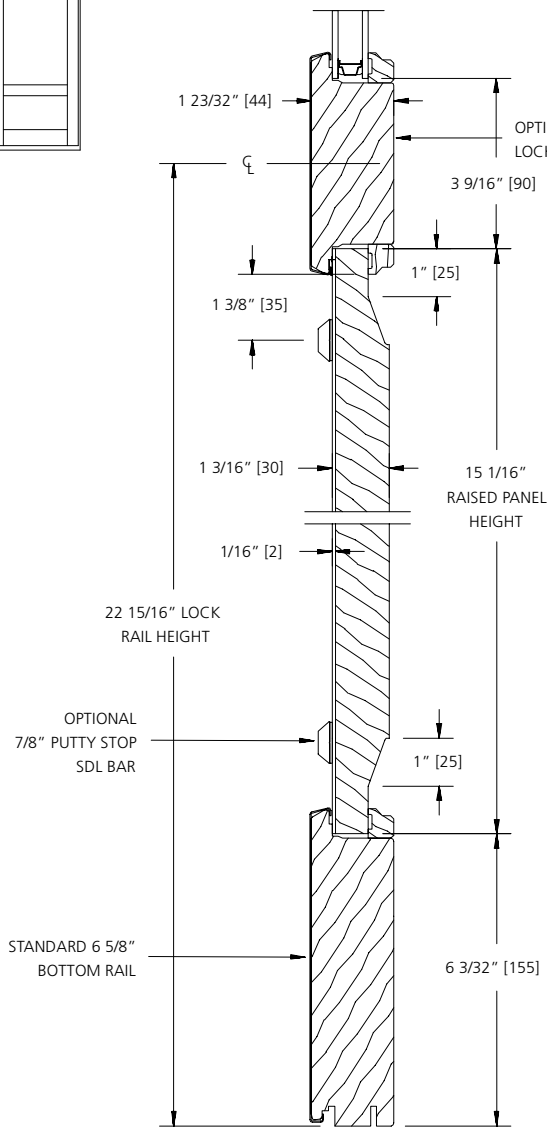
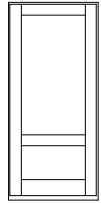

**VERTICAL SECTION**

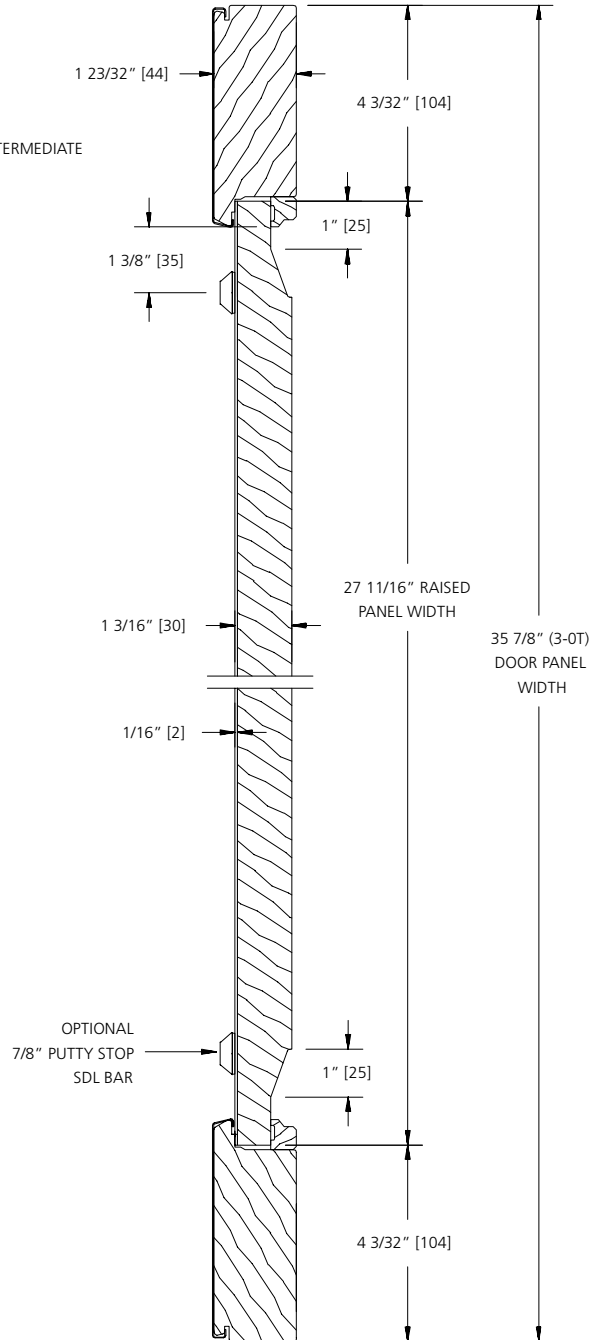

**HORIZONTAL SECTION**

SCALE: 3" = 1'



**STANDARD MULLION DETAILS**

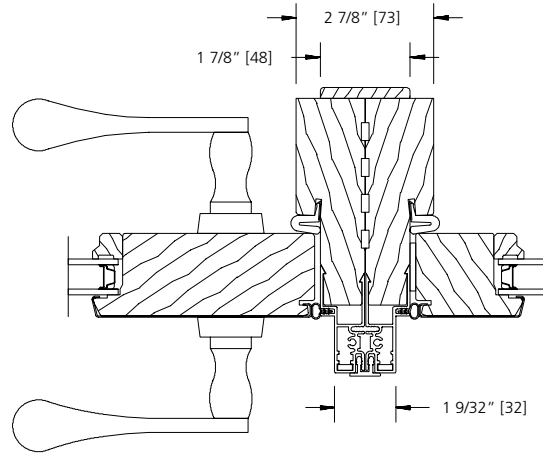

**SIDE JAMB**

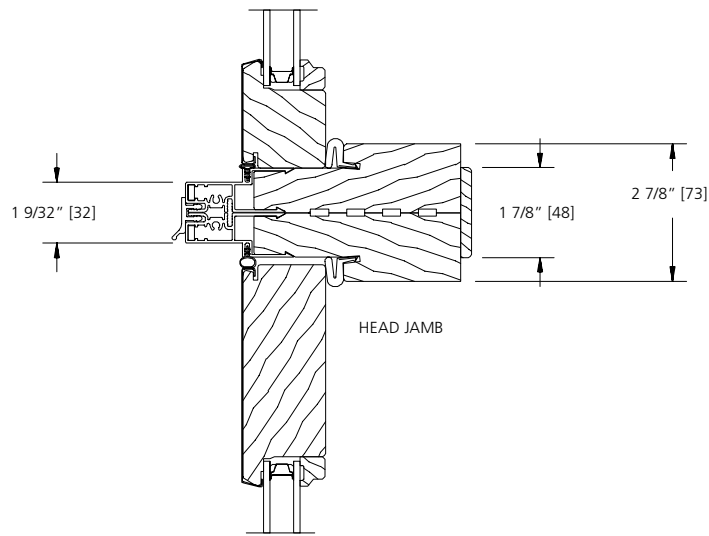

**TRANSOM SILL**

SCALE: 3" = 1'

**LITE CUT INFORMATION**

Clad out-swing patio doors are available with removable grilles in 7/8", 1-1/8" and 1-3/8" widths, with GBG (Grilles between the Glass), or with Simulated Divided Lites. Standard lite cuts are rectangular.

**LITE CUT OPTIONS**

Special lite cut patterns can include a wide variety of straight line and radius patterns. The illustrations shown here represent just a few of the possibilities. Rectangular, horizontal, vertical and Prairie lite patterns are available in all standard size clad swinging patio doors. Uneven, diamond, radius, and gothic lite cuts are available, subject to approval. Approvals are based on the ability to fulfill the design requirement while maintaining the construction integrity of the finished product.

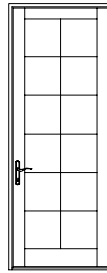

RECTANGULAR

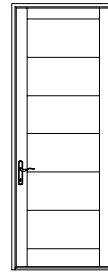

HORIZONTAL

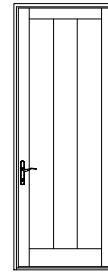

VERTICAL

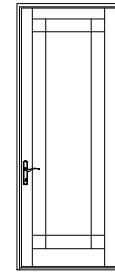

PRAIRIE

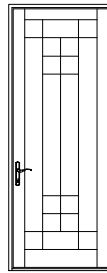

UNEVEN

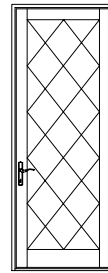

DIAMOND

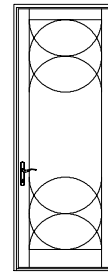

RADIUS

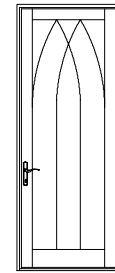

GOthic

**BAR ALIGNMENT**

Alignment of divided lite muntin bars from one product to the next is often required by fine architectural design. Wood grilles, GBG (Grilles between the Glass), and Simulated Divided Lites may be specified with muntin bars aligned.

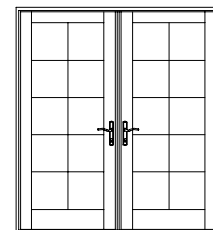
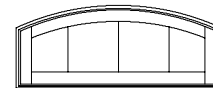
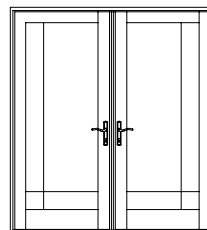
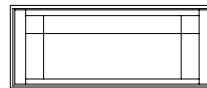

**CLEAR OPENING LAYOUT**

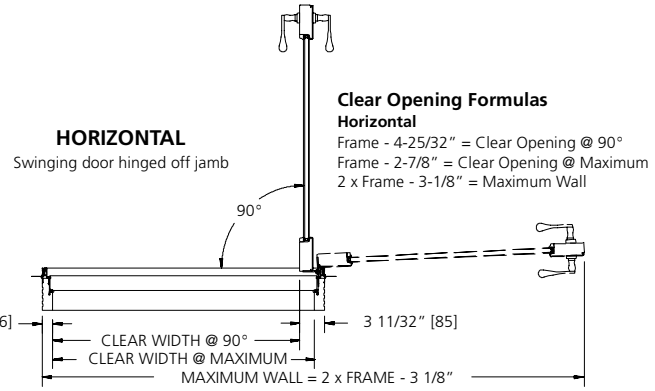
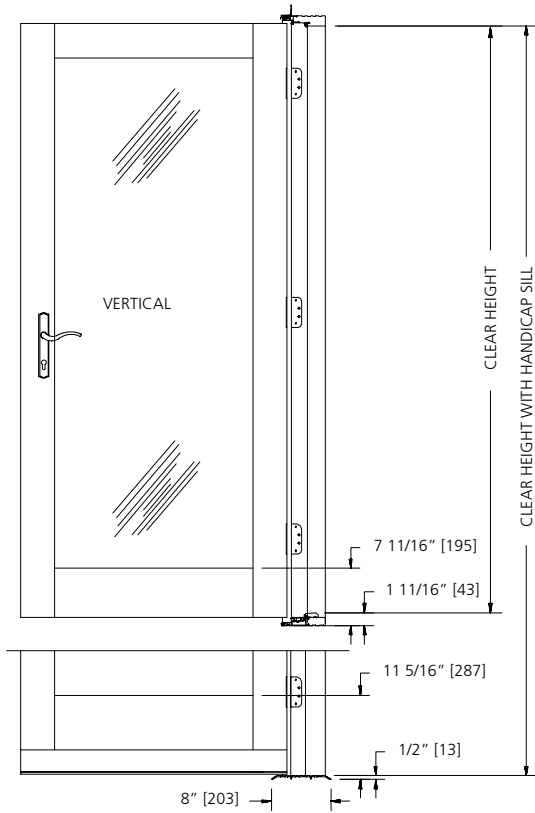

NOTE: DETAILS ARE SHOWN WITH STANDARD HINGES. OPERATION OF UNITS WITH ADJUSTABLE HINGES WILL HAVE LIMITED ROTATION.

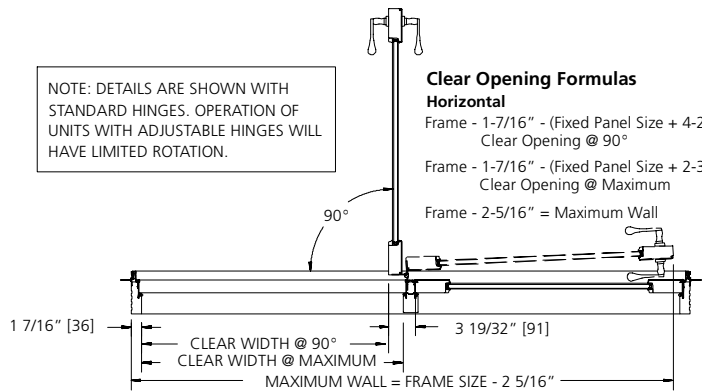

**Vertical**  
Standard sill  
Frame - 3 1/8" = Clear height  
Handicap sill  
Frame - 1 15/16" = Clear height  
Daylight opening height at bottom rail to handicap sill is 11 5/16" with 10-1/4" bottom rail, and 7 11/16" with standard bottom rail.

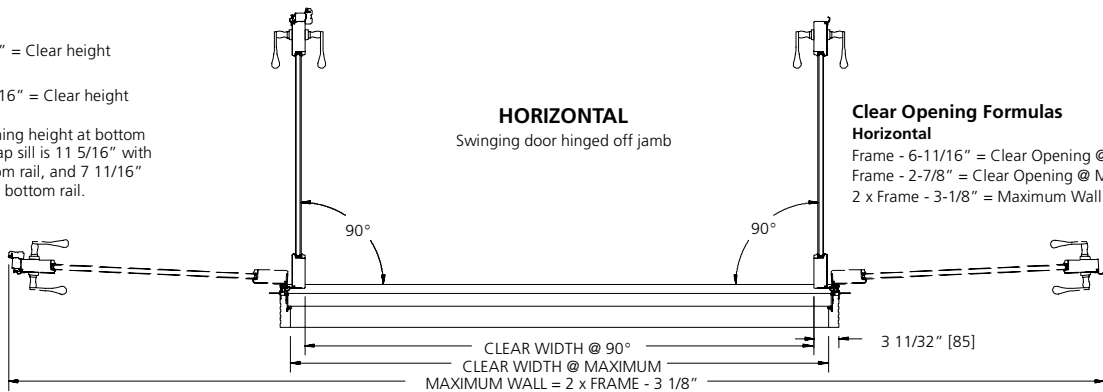

Panel Callout	Panel Width
2-0 Retro	21-7/8
2-6 Retro	27-7/8
2-8 Retro	29-7/8
3-0 Retro	33-7/8
2-0 True	23-7/8
2-6 True	29-7/8
2-8 True	31-7/8
3-0 True	35-7/8
3-6 True	41-7/8

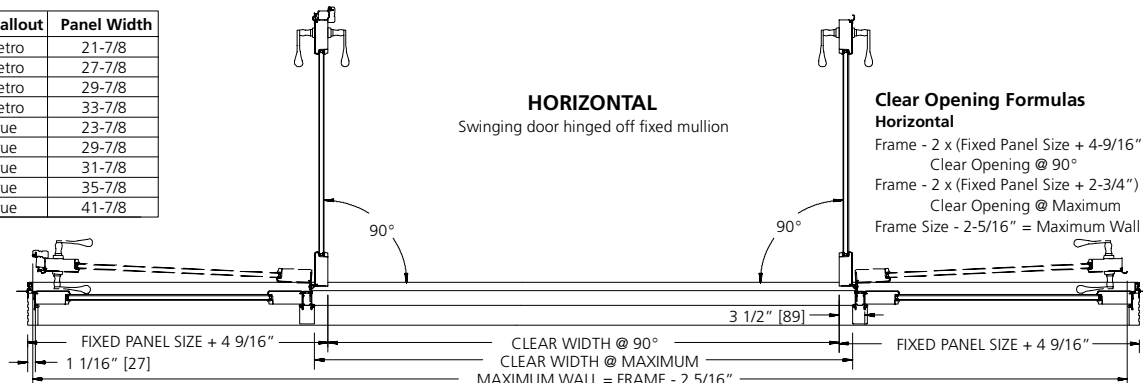

### CLEAR OPENING INFORMATION

#### BASIC UNITS

Unit Number	Frame Width	Frame Height	Square Feet of Clear Opening	Clear Opening Width Inches	Clear Opening Height Inches	Clear Opening Height Handicap Sill	Square Feet of Daylight Opening Per Panel	Square Feet of Daylight Opening 10-1/4" Bottom Rail	Unit Number	Frame Width	Frame Height	Square Feet of Clear Opening	Clear Opening Width Inches	Clear Opening Height Inches	Clear Opening Height Handicap Sill	Square Feet of Daylight Opening Per Panel	Square Feet of Daylight Opening 10-1/4" Bottom Rail
<b>Swinging Door Basic Units</b>									<b>Swinging Door Basic Units (cont.)</b>								
<b>1-Panel Units</b>									<b>3-Panel Center Operator</b>								
COSWR2068	24.00	79.13	10.14	19.22	76.00	77.19	5.76	5.44	COSWR7668	88.38	79.13	13.31	25.22	76.00	77.19	8.50	8.03
COSWR2668	30.00	79.13	13.31	25.22	76.00	77.19	8.50	8.03	COSWR8068	94.38	79.13	14.37	27.22	76.00	77.19	9.41	8.89
COSWR2868	32.00	79.13	14.37	27.22	76.00	77.19	9.41	8.89	COSWR9068	106.38	79.13	16.48	31.22	76.00	77.19	11.24	10.62
COSWR3068	36.00	79.13	16.48	31.22	76.00	77.19	11.24	10.62	COSWR7680	88.38	95.13	16.11	25.22	92.00	93.19	10.57	10.10
COSWR2080	24.00	95.13	12.28	19.22	92.00	93.19	7.16	6.85	COSWR8080	94.38	95.13	17.39	27.22	92.00	93.19	11.70	11.19
COSWR2680	30.00	95.13	16.11	25.22	92.00	93.19	10.57	10.10	COSWR9080	106.38	95.13	19.95	31.22	92.00	93.19	13.97	13.35
COSWR2880	32.00	95.13	17.39	27.22	92.00	93.19	11.70	11.19	COSWR7690	88.38	107.13	18.21	25.22	104.00	105.19	12.12	11.65
COSWR3080	36.00	95.13	19.95	31.22	92.00	93.19	13.97	13.35	COSWR8090	94.38	107.13	19.66	27.22	104.00	105.19	13.42	12.90
COSWR2090	24.00	107.13	13.88	19.22	104.00	105.19	8.22	7.90	COSWR9090	106.38	107.13	22.55	31.22	104.00	105.19	16.03	15.41
COSWR2690	30.00	107.13	18.21	25.22	104.00	105.19	12.12	11.65	COSWR7668	94.38	82.13	14.93	27.22	79.00	80.19	9.84	9.32
COSWR2890	32.00	107.13	19.66	27.22	104.00	105.19	13.42	12.90	COSWT8068	100.38	82.13	16.03	29.22	79.00	80.19	10.80	10.23
COSWR3090	36.00	107.13	22.55	31.22	104.00	105.19	16.03	15.41	COSWR9068	112.38	82.13	18.22	33.22	79.00	80.19	12.71	12.04
COSWT2068	26.00	82.13	11.64	21.22	79.00	80.19	6.98	6.61	COSWT7670	94.38	86.13	15.69	27.22	83.00	84.19	10.42	9.90
COSWT2668	32.00	82.13	14.93	27.22	79.00	80.19	9.84	9.32	COSWT8070	100.38	86.13	16.48	29.22	83.00	84.19	11.43	10.86
COSWT2868	34.00	82.13	16.03	29.22	79.00	80.19	10.80	10.23	COSWT9070	112.38	86.13	19.15	33.22	83.00	84.19	13.45	12.78
COSWT3068	38.00	82.13	18.22	33.22	79.00	80.19	12.71	12.04	COSWT7680	94.38	98.13	17.96	27.22	95.00	96.19	12.13	11.61
COSWT3668	44.00	82.13	21.52	39.22	79.00	80.19	15.57	14.75	COSWT8080	100.38	98.13	19.28	29.22	95.00	96.19	13.31	12.74
COSWT2070	26.00	86.13	12.23	21.22	83.00	84.19	7.39	7.02	COSWT9080	112.38	98.13	21.92	33.22	95.00	96.19	15.66	14.99
COSWT2670	32.00	86.13	15.69	27.22	83.00	84.19	10.42	9.90	COSWT7680	94.38	110.13	20.23	27.22	107.00	108.19	13.85	13.33
COSWT2870	34.00	86.13	16.84	29.22	83.00	84.19	11.43	10.86	COSWT8080	100.38	110.13	21.71	29.22	107.00	108.19	15.20	14.63
COSWT3070	38.00	86.13	19.15	33.22	83.00	84.19	13.45	12.78	COSWT9080	112.38	110.13	24.68	33.22	107.00	108.19	17.88	17.21
COSWT3670	44.00	86.13	22.61	39.22	83.00	84.19	16.48	15.65	<b>1-Panel Operator with Sidelight</b>								
COSWT2080	26.00	98.13	14.00	21.22	95.00	96.19	8.60	8.24	COSWT3068B10	51.31	82.13	18.22	33.22	79.00	80.19	12.71/3.58	12.04/3.39
COSWT2680	32.00	98.13	17.96	27.22	95.00	96.19	12.13	11.61	COSWT3068B12	53.31	82.13	18.22	33.22	79.00	80.19	12.71/4.53	12.04/4.29
COSWT2880	34.00	98.13	19.28	29.22	95.00	96.19	13.31	12.74	COSWT3068B14	55.31	82.13	18.22	33.22	79.00	80.19	12.71/5.49	12.04/5.20
COSWT3080	38.00	98.13	21.92	33.22	95.00	96.19	14.99	14.37	COSWT3070B10	51.31	86.13	19.15	33.22	83.00	84.19	13.45/3.79	12.78/3.60
COSWT3680	44.00	98.13	25.87	39.22	95.00	96.19	18.37	17.51	COSWT3070B12	53.31	86.13	19.15	33.22	83.00	84.19	13.45/4.80	12.78/4.56
COSWT2090	26.00	110.13	15.77	21.22	107.00	108.19	9.45	9.05	COSWT3070B14	55.31	86.13	19.15	33.22	83.00	84.19	13.45/5.81	12.78/5.52
COSWT2690	32.00	110.13	20.23	27.22	107.00	108.19	13.85	13.33	COSWT3080B10	51.31	98.13	21.92	33.22	95.00	96.19	15.66/4.41	14.99/4.22
COSWT2890	34.00	110.13	21.71	29.22	107.00	108.19	15.20	14.63	COSWT3080B12	53.31	98.13	21.92	33.22	95.00	96.19	15.66/5.59	14.99/5.35
COSWT3090	38.00	110.13	24.68	33.22	107.00	108.19	17.88	17.21	COSWT3080B14	55.31	98.13	21.92	33.22	95.00	96.19	15.66/6.77	14.99/6.48
<b>2-Panel Units</b>									<b>3-Panel Operator with Twin Sidelights</b>								
COSWR5068	59.19	79.13	13.33	25.25	76.00	77.19	8.50	8.03	COSWT3068F10	64.63	82.13	18.24	33.25	79.00	80.19	12.71/3.58	12.04/3.39
COSWR5468	63.19	79.13	14.38	27.25	76.00	77.19	9.41	8.89	COSWT3068F12	68.63	82.13	18.24	33.25	79.00	80.19	12.71/4.53	12.04/4.29
COSWR6068	71.19	79.13	16.49	31.25	76.00	77.19	11.24	10.62	COSWT3068F14	72.63	82.13	18.24	33.25	79.00	80.19	12.71/5.49	12.04/5.20
COSWR5080	59.19	95.13	16.13	25.25	92.00	93.19	10.57	10.10	COSWT3070F10	64.63	86.13	19.16	33.25	83.00	84.19	13.45/3.79	12.78/3.60
COSWR5480	63.19	95.13	17.41	27.25	92.00	93.19	11.70	11.19	COSWT3070F12	68.63	86.13	19.16	33.25	83.00	84.19	13.45/4.80	12.78/4.56
COSWR6080	71.19	95.13	19.97	31.25	92.00	93.19	13.97	13.35	COSWT3070F14	72.63	86.13	19.16	33.25	83.00	84.19	13.45/5.81	12.78/5.52
COSWR5090	59.19	107.13	18.24	25.25	104.00	105.19	12.12	11.65	COSWT3080F10	64.63	98.13	21.94	33.25	95.00	96.19	15.66/4.41	14.99/4.22
COSWR5490	63.19	107.13	19.68	27.25	104.00	105.19	13.42	12.90	COSWT3080F12	68.63	98.13	21.94	33.25	95.00	96.19	15.66/5.59	14.99/5.35
COSWR6090	71.19	107.13	22.57	31.25	104.00	105.19	16.03	15.41	COSWT3080F14	72.63	98.13	21.94	33.25	95.00	96.19	15.66/6.77	14.99/6.48
COSWT5068	63.19	82.13	14.95	27.25	79.00	80.19	9.84	9.32	COSWT3090F10	64.63	110.13	24.71	33.25	107.00	108.19	17.88/5.04	17.21/4.85
COSWT5468	67.19	82.13	16.05	29.25	79.00	80.19	10.80	10.23	COSWT3090F12	68.63	110.13	24.71	33.25	107.00	108.19	17.88/6.38	17.21/6.14
COSWT6068	75.19	82.13	18.24	33.25	79.00	80.19	12.71	12.04	COSWT3090F14	72.63	110.13	24.71	33.25	107.00	108.19	17.88/7.72	17.21/7.43
COSWT7068	87.19	82.13	21.53	39.25	79.00	80.19	15.57	14.75	COSWT3668F10	70.63	82.13	21.53	39.25	79.00	80.19	15.57/3.58	14.75/3.39
COSWT5070	63.19	86.13	15.71	27.25	83.00	84.19	10.42	9.90	COSWT3668F12	74.63	82.13	21.53	39.25	79.00	80.19	15.57/4.53	14.75/4.29
COSWT5470	67.19	86.13	16.86	29.25	83.00	84.19	11.43	10.86	COSWT3668F14	78.63	82.13	21.53	39.25	79.00	80.19	15.57/5.49	14.75/5.20
COSWT6070	75.19	86.13	19.16	33.25	83.00	84.19	13.45	12.78	COSWT3670F10	70.63	86.13	22.62	39.25	83.00	84.19	16.48/3.79	15.65/3.60
COSWT7070	87.19	86.13	22.62	39.25	83.00	84.19	16.48	15.65	COSWT3670F12	74.63	86.13	22.62	39.25	83.00	84.19	16.48/4.80	15.65/4.56
COSWT5080	63.19	98.13	17.98	27.25	95.00	96.19	12.13	11.61	COSWT3670F14	78.63	86.13	22.62	39.25	83.00	84.19	16.48/5.81	15.65/5.52
COSWT5480	67.19	98.13	19.30	29.25	95.00	96.19	13.31	12.74	COSWT3680F10	70.63	98.13	25.89	39.25	95.00	96.19	19.19/4.41	18.37/4.22
COSWT6080	75.19	98.13	21.94	33.25	95.00	96.19	15.66	14.99	COSWT3680F12	74.63	98.13	25.89	39.25	95.00	96.19	19.19/5.59	18.37/5.35
COSWT7080	87.19	98.13	25.89	39.25	95.00	96.19	19.19	18.37	COSWT3680F14	78.63	98.13	25.89	39.25	95.00	96.19	19.19/6.77	18.37/6.48
COSWT5090	63.19	110.13	20.25	27.25	107.00	108.19	13.85	13.33	<b>3-Panel End Operator</b>								
COSWT5490	67.19	110.13	21.73	29.25	107.00	108.19	15.20	14.63	COSWR7668	88.38	79.13	13.31	25.22	76.00	77.19	8.50	8.03
COSWT6090	75.19	110.13	24.71	33.25	107.00	108.19	17.88	17.21	COSWR8068	94.38	79.13	14.37	27.22	76.00	77.19	9.41	8.89
<b>3-Panel End Operator</b>									COSWR9068	106.38	79.13	16.48	31.22	76.00	77.19	11.24	10.62
COSWR7668	88.38	79.13	13.31	25.22	76.00	77.19	8.50	8.03	COSWR7680	88.38	95.13	16.11	25.22	92.00	93.19	10.57	10.10
COSWR8068	94.38	79.13	14.37	27.22	76.00	77.19	9.41	8.89	COSWR8080	94.38	95.13	17.39	27.22	92.00	93.19	11.70	11.19
COSWR9068	106.38	79.13	16.48	31.22	76.00	77.19	11.24	10.62	COSWR9080	106.38	95.13	19.95	31.22	92.00	93.19	13.97	13.35
COSWR7680	88.38	95.13	16.11	25.22	92.00	93.19	10.57	10.10	COSWR7690	88.38	107.13	18.21	25.22	104.00	105.19	12.12	11.65
COSWR8080	94.38	95.13	17.39	27.22	92.00	93.19	11.70	11.19	COSWR8090	94.38	107.13	19.66	27.22	10			

**CLEAR OPENING INFORMATION**  
**BASIC UNITS**

Unit Number	Frame Width	Frame Height	Square Feet of Clear Opening	Clear Opening Width Inches	Clear Opening Height Inches	Clear Opening Height Handicap Sill	Square Feet of Daylight Opening Per Panel	Square Feet of Daylight Opening 10-1/4" Bottom Rail	Unit Number	Frame Width	Frame Height	Square Feet of Clear Opening	Clear Opening Width Inches	Clear Opening Height Inches	Clear Opening Height Handicap Sill	Square Feet of Daylight Opening Per Panel	Square Feet of Daylight Opening 10-1/4" Bottom Rail
<b>French Door Basic Units</b>									<b>French Door Basic Units (cont.)</b>								
<b>2-Panel Active, Inactive</b>									<b>2-Panel French Door with Twin Sidelights (cont.)</b>								
COFRR4068	47.19	79.13	21.38	40.50	76.00	77.19	5.76	5.44	COFRT6068Q10	101.81	82.13	37.68	68.69	79.00	80.19	12.71/3.58	12.04/3.39
COFRR5068	59.19	79.13	27.71	52.50	76.00	77.19	8.50	8.03	COFRT6068Q12	105.81	82.13	37.68	68.69	79.00	80.19	12.71/4.06	12.04/3.84
COFRR5468	63.19	79.13	29.82	56.50	76.00	77.19	9.41	8.89	COFRT6068Q14	109.81	82.13	37.68	68.69	79.00	80.19	12.71/4.53	12.04/4.29
COFRR6068	71.19	79.13	34.04	64.50	76.00	77.19	11.24	10.62	COFRT6070Q10	101.81	86.13	39.59	68.69	83.00	84.19	13.45/3.79	12.78/3.60
COFRR4080	47.19	95.13	25.88	40.50	92.00	93.19	7.16	6.85	COFRT6070Q12	105.81	86.13	39.59	68.69	83.00	84.19	13.45/4.29	12.78/4.08
COFRR5080	59.19	95.13	33.54	52.50	92.00	93.19	10.57	10.10	COFRT6070Q14	109.81	86.13	39.59	68.69	83.00	84.19	13.45/4.80	12.78/4.56
COFRR5480	63.19	95.13	36.10	56.50	92.00	93.19	11.70	11.19	COFRT6080Q10	101.81	98.13	45.31	68.69	95.00	96.19	15.66/4.41	14.99/4.22
COFRR6080	71.19	95.13	41.21	64.50	92.00	93.19	13.97	13.35	COFRT6080Q12	105.81	98.13	45.31	68.69	95.00	96.19	15.66/5.00	14.99/4.79
COFRR4090	47.19	95.13	25.88	40.50	92.00	93.19	7.16	6.85	COFRT6080Q14	109.81	98.13	45.31	68.69	95.00	96.19	15.66/5.59	14.99/5.35
COFRR5090	59.19	95.13	33.54	52.50	92.00	93.19	10.57	10.10	COFRT6090Q10	101.81	110.13	51.04	68.69	107.00	108.19	17.88/5.04	17.21/4.85
COFRR5490	63.19	95.13	36.10	56.50	92.00	93.19	11.70	11.19	COFRT6090Q12	105.81	110.13	51.04	68.69	107.00	108.19	17.88/5.68	17.21/5.44
COFRR6090	71.19	95.13	41.21	64.50	92.00	93.19	13.97	13.35	COFRT6090Q14	109.81	110.13	51.04	68.69	107.00	108.19	17.88/7.72	17.21/7.43
COFRT4068	51.19	82.13	24.41	44.50	79.00	80.19	6.98	6.61	COFRT7068Q10	113.81	82.13	44.27	80.69	79.00	80.19	15.57/3.58	14.75/3.39
COFRT5068	63.19	82.13	31.00	56.50	79.00	80.19	9.84	9.32	COFRT7068Q12	117.81	82.13	44.27	80.69	79.00	80.19	15.57/4.06	14.75/3.84
COFRT5468	67.19	82.13	33.19	60.50	79.00	80.19	10.80	10.23	COFRT7068Q14	121.81	82.13	44.27	80.69	79.00	80.19	15.57/4.53	14.75/4.29
COFRT6068	75.19	82.13	37.58	68.50	79.00	80.19	12.71	12.04	COFRT7070Q10	113.81	86.13	46.51	80.69	83.00	84.19	16.48/3.79	15.65/3.60
COFRT7068	87.19	82.13	44.16	80.50	79.00	80.19	15.57	14.75	COFRT7070Q12	117.81	86.13	46.51	80.69	83.00	84.19	16.48/4.29	15.65/4.08
COFRT4070	51.19	86.13	25.65	44.50	83.00	84.19	7.39	7.02	COFRT7070Q14	121.81	86.13	46.51	80.69	83.00	84.19	16.48/4.80	15.65/4.56
COFRT5070	63.19	86.13	32.57	56.50	83.00	84.19	10.42	9.90	COFRT7080Q10	113.81	98.13	53.23	80.69	95.00	96.19	19.19/4.41	18.37/4.22
COFRT5470	67.19	86.13	34.87	60.50	83.00	84.19	11.43	10.86	COFRT7080Q12	117.81	98.13	53.23	80.69	95.00	96.19	19.19/5.00	18.37/4.79
COFRT6070	75.19	86.13	39.48	68.50	83.00	84.19	13.45	12.78	COFRT7080Q14	121.81	98.13	53.23	80.69	95.00	96.19	19.19/5.59	18.37/5.35
COFRT7070	87.19	86.13	46.40	80.50	83.00	84.19	16.48	15.65									
COFRT4080	51.19	98.13	29.36	44.50	95.00	96.19	8.60	8.24									
COFRT5080	63.19	98.13	37.27	56.50	95.00	96.19	12.13	11.61									
COFRT5480	67.19	98.13	39.91	60.50	95.00	96.19	13.31	12.74									
COFRT6080	75.19	98.13	45.19	68.50	95.00	96.19	15.66	14.99									
COFRT7080	87.19	98.13	53.11	80.50	95.00	96.19	19.19	18.37									
COFRT4090	51.19	110.13	33.07	44.50	107.00	108.19	9.82	9.45									
COFRT5090	63.19	110.13	41.98	56.50	107.00	108.19	13.85	13.33									
COFRT5490	67.19	110.13	39.91	60.50	107.00	108.19	15.20	14.63									
COFRT6090	75.19	110.13	45.19	68.50	107.00	108.19	17.88	17.21									
<b>4-Panel Units</b>									<b>Door Transom Basic Units</b>								
COFRR8068	93.56	79.13	21.47	40.69	76.00	77.19	5.76	5.44	<b>Single Door Transoms</b>								
COFRR10068	117.56	79.13	27.81	52.69	76.00	77.19	8.50	8.03	CTOSWR2016	24.00	18.0	N/A	N/A	N/A	N/A	1.01	N/A
COFRR12068	141.56	79.13	34.14	64.69	76.00	77.19	11.24	10.62	CTOSWR2616	30.00	18.0	N/A	N/A	N/A	N/A	1.49	N/A
COFRR8080	93.56	95.13	25.99	40.69	92.00	93.19	7.16	6.85	CTOSWR2816	32.00	18.0	N/A	N/A	N/A	N/A	1.65	N/A
COFRR10080	117.56	95.13	33.66	52.69	92.00	93.19	8.50	8.03	CTOSWR3016	36.00	18.0	N/A	N/A	N/A	N/A	1.97	N/A
COFRR12080	141.56	95.13	41.33	64.69	92.00	93.19	13.97	13.35	CTOSWR2026	24.00	30.0	N/A	N/A	N/A	N/A	2.06	N/A
COFRR8090	93.56	107.13	29.39	40.69	104.00	105.19	8.22	7.90	CTOSWR2626	30.00	30.0	N/A	N/A	N/A	N/A	3.04	N/A
COFRR10090	117.56	107.13	38.05	52.69	104.00	105.19	12.12	11.65	CTOSWR2826	32.00	30.0	N/A	N/A	N/A	N/A	3.37	N/A
COFRR12090	141.56	107.13	41.33	64.69	104.00	105.19	13.97	13.35	CTOSWR3026	36.00	30.0	N/A	N/A	N/A	N/A	4.35	N/A
COFRT8068	101.56	82.13	24.52	44.69	79.00	80.19	6.98	6.61	CTOSWR1016	14.13	18.0	N/A	N/A	N/A	N/A	0.60	N/A
COFRT10068	125.56	82.13	31.10	56.69	79.00	80.19	9.84	9.32	CTOSWT1216	16.13	18.0	N/A	N/A	N/A	N/A	0.76	N/A
COFRT12068	149.56	82.13	37.68	68.69	79.00	80.19	12.71	12.04	CTOSWT1416	18.13	18.0	N/A	N/A	N/A	N/A	0.92	N/A
COFRT8070	101.56	86.13	25.76	44.69	83.00	84.19	7.39	7.02	CTOSWT1026	14.13	30.0	N/A	N/A	N/A	N/A	1.22	N/A
COFRT10070	125.56	86.13	32.67	56.69	83.00	84.19	10.42	9.90	CTOSWT1226	16.13	30.0	N/A	N/A	N/A	N/A	1.55	N/A
COFRT12070	149.56	86.13	39.59	68.69	83.00	84.19	13.45	12.78	CTOSWT1426	18.13	30.0	N/A	N/A	N/A	N/A	1.88	N/A
COFRT8080	101.56	98.13	29.48	44.69	95.00	96.19	8.60	8.24	CTOSWT2016	26.00	18.0	N/A	N/A	N/A	N/A	1.17	N/A
COFRT10080	125.56	98.13	37.40	56.69	95.00	96.19	12.13	11.61	CTOSWT2616	32.00	18.0	N/A	N/A	N/A	N/A	1.65	N/A
COFRT12080	149.56	98.13	45.31	68.69	95.00	96.19	15.66	14.99	CTOSWT2816	34.00	18.0	N/A	N/A	N/A	N/A	2.11	N/A
COFRT8090	101.56	110.13	33.21	44.69	107.00	108.19	9.82	9.45	CTOSWT3016	38.00	18.0	N/A	N/A	N/A	N/A	1.83	N/A
COFRT10090	125.56	110.13	42.12	56.69	107.00	108.19	13.85	13.33	CTOSWT3616	44.00	18.0	N/A	N/A	N/A	N/A	2.61	N/A
COFRT12090	149.56	110.13	51.04	68.69	107.00	108.19	17.88	17.21	CTOSWT2026	26.00	30.0	N/A	N/A	N/A	N/A	2.39	N/A
<b>2-Panel French Door with Twin Sidelights</b>									<b>French Door Transoms</b>								
COFRT5068Q10	89.81	82.13	31.10	56.69	79.00	80.19	9.84/3.58	9.32/3.39	CTOSWR4016	47.19	18.0	N/A	N/A	N/A	N/A	2.86	N/A
COFRT5068Q12	93.81	82.13	31.10	56.69	79.00	80.19	9.84/4.06	9.32/3.84	CTOSWR5016	59.19	18.0	N/A	N/A	N/A	N/A	3.12	N/A
COFRT5068Q14	97.81	82.13	31.10	56.69	79.00	80.19	9.84/4.53	9.32/4.29	CTOSWR5416	63.19	18.0	N/A	N/A	N/A	N/A	3.41	N/A
COFRT5070Q10	89.81	86.13	32.67	56.69	83.00	84.19	10.42/3.79	9.90/3.60	CTOSWR6016	71.19	18.0	N/A	N/A	N/A	N/A	3.78	N/A
COFRT5070Q12	93.81	86.13	32.67	56.69	83.00	84.19	10.42/4.29	9.90/4.08	CTOSWT5016	63.19	18.0	N/A	N/A	N/A	N/A	4.14	N/A
COFRT5070Q14	97.81	86.13	32.67	56.69	83.00	84.19	10.42/4.80	9.90/4.56	CTOSWT5416	67.19	18.0	N/A	N/A	N/A	N/A	4.46	N/A
COFRT5080Q10	89.81	98.13	37.40	56.69	95.00	96.19	12.13/4.41	11.61/4.22	CTOSWT6016	75.19	18.0	N/A	N/A	N/A	N/A	5.10	N/A
COFRT5080Q12	93.81	98.13	37.40	56.69	95.00	96.19	12.13/5.00	11.61/4.79	CTOSWT7016	87.19	18.0	N/A	N/A	N/A	N/A	6.05	N/A
COFRT5080Q14	97.81	98.13	37.40	56.69	95.00	96											

**CLEAR OPENING LAYOUT  
RADIUS**

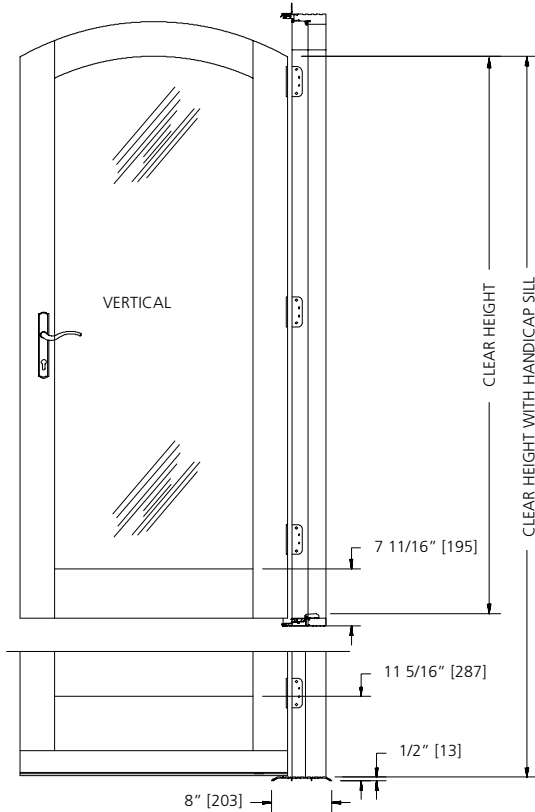

NOTE: DETAILS ARE SHOWN WITH STANDARD HINGES. OPERATION OF UNITS WITH ADJUSTABLE HINGES WILL HAVE LIMITED ROTATION.

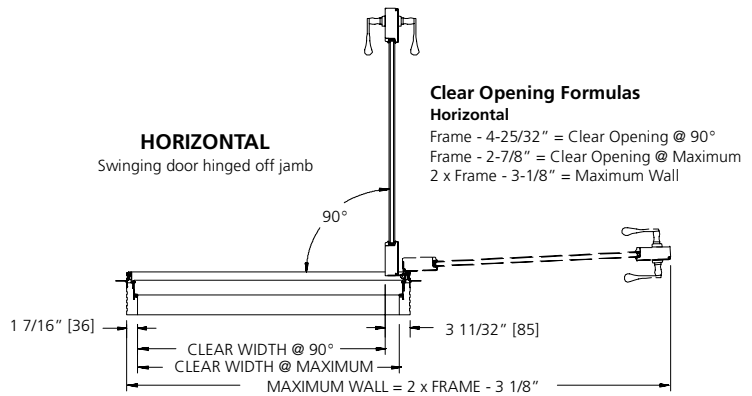

**Vertical**  
Radius head clear opening height varies with unit width - see table.

Daylight opening height at bottom rail to handicap sill is 11 5/16" with 10-1/4" bottom rail, and 7 11/16" with standard bottom rail.

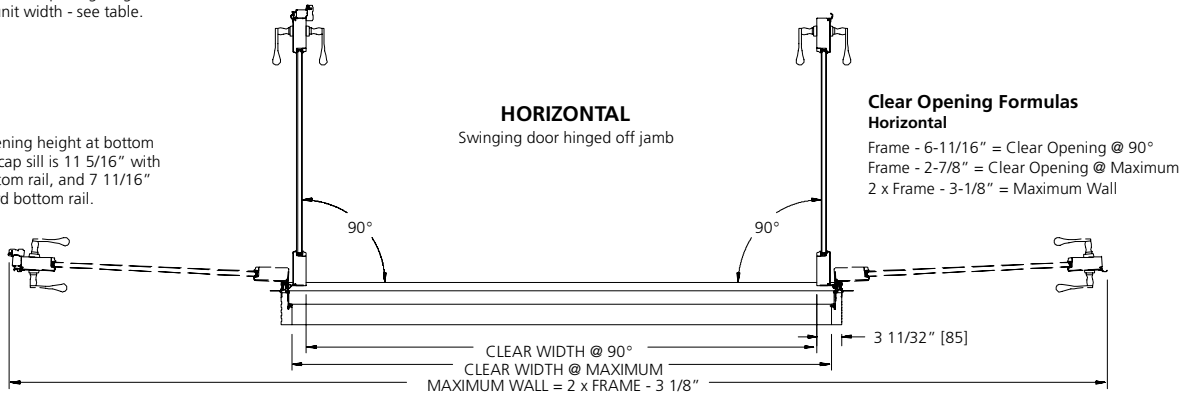

Panel Callout	Panel Width
2-0 True	23-7/8
2-6 True	29-7/8
2-8 True	31-7/8
3-0 True	35-7/8
3-6 True	41-7/8

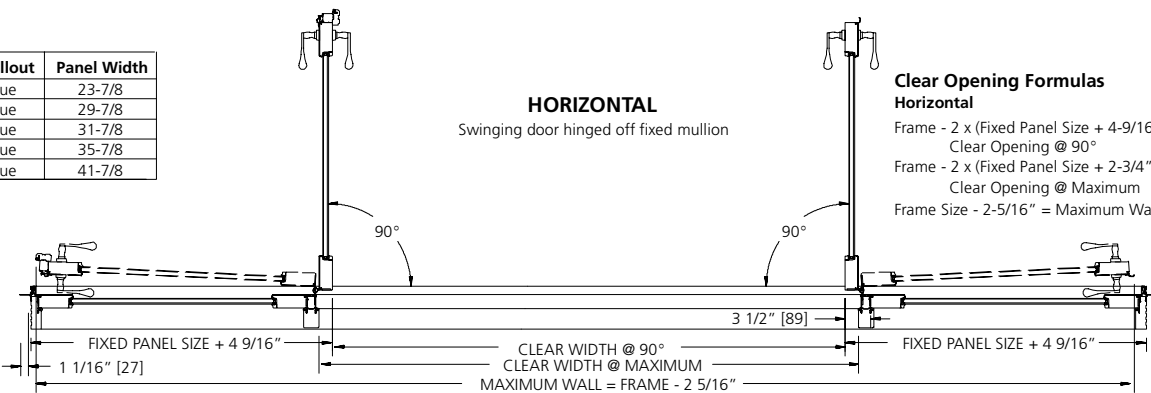

**CLEAR OPENING INFORMATION**  
**RADIUS UNITS**

Unit Number	Frame Width	Frame Height	Square Feet of Clear Opening	Clear Opening Width Inches	Clear Opening Height Inches	Clear Opening Height Handicap Sill	Square Feet of Daylight Opening Per Panel	Square Feet of Daylight Opening 10-1/4" Bottom Rail	Unit Number	Frame Width	Frame Height	Square Feet of Clear Opening	Clear Opening Width Inches	Clear Opening Height Inches	Clear Opening Height Handicap Sill	Square Feet of Daylight Opening Per Panel	Square Feet of Daylight Opening 10-1/4" Bottom Rail
<b>Swinging Door Basic Units</b>									<b>French Door Basic Units (cont.)</b>								
<b>1-Panel Units</b>									<b>2-Panel Active, Inactive with Twin Sidelights</b>								
COSWTS2068	26.00	82.13	11.41	21.22	77.41	78.59	6.98	6.61	COFRTS5068Q10	89.81	82.13	29.27	56.69	74.34	75.53	9.82/3.20	9.30/3.01
COSWTS2668	32.00	82.13	14.41	27.22	76.22	77.41	9.84	9.32	COFRTS5068Q12	93.81	82.13	29.27	56.69	74.34	75.53	9.82/4.06	9.30/3.82
COSWTS2868	34.00	82.13	15.48	29.22	76.38	77.56	10.80	10.23	COFRTS5068Q14	97.81	82.13	29.27	56.69	74.34	75.53	9.82/4.91	9.30/4.62
COSWTS3068	38.00	82.13	17.40	33.22	75.44	76.63	12.70	12.04	COFRTS5070Q10	89.81	86.13	30.84	56.69	78.34	79.53	10.39/3.41	9.87/3.22
COSWTS3668	44.00	82.13	21.52	39.22	73.81	75.00	15.24	14.42	COFRTS5070Q12	93.81	86.13	30.84	56.69	78.34	79.53	10.39/4.32	9.87/4.08
COSWTS2070	26.00	86.13	12.00	21.22	81.41	82.59	7.39	7.02	COFRTS5070Q14	97.81	86.13	30.84	56.69	78.34	79.53	10.39/5.23	9.87/4.94
COSWTS2670	32.00	86.13	15.16	27.22	80.22	81.41	10.42	9.90	COFRTS5080Q10	89.81	98.13	35.57	56.69	90.34	91.53	12.11/4.04	11.59/3.85
COSWTS2870	34.00	86.13	16.30	29.22	80.38	81.56	11.43	10.86	COFRTS5080Q12	93.81	98.13	35.57	56.69	90.34	91.53	12.11/5.11	11.59/4.87
COSWTS3070	38.00	86.13	18.33	33.22	79.44	80.63	13.45	12.78	COFRTS5080Q14	97.81	98.13	35.57	56.69	90.34	91.53	12.11/6.19	11.59/5.90
COSWTS3670	44.00	86.13	22.61	39.22	77.81	79.00	16.15	15.32	COFRTS5090Q10	89.81	110.13	40.29	56.69	102.34	103.53	13.83/5.90	13.31/5.67
COSWTS2080	26.00	98.13	13.76	21.22	93.41	94.59	8.60	8.24	COFRTS5090Q12	93.81	110.13	40.29	56.69	102.34	103.53	13.83/7.15	13.31/6.86
COSWTS2680	32.00	98.13	17.43	27.22	92.22	93.41	12.13	11.61	COFRTS5090Q14	97.81	110.13	40.29	56.69	102.34	103.53	13.83/8.41	13.31/8.12
COSWTS2880	34.00	98.13	18.73	29.22	92.38	93.56	13.31	12.74	COFRTS5468Q10	93.81	82.13	31.04	60.69	73.66	74.84	10.76/3.16	10.20/2.96
COSWTS3080	38.00	98.13	21.09	33.22	91.44	92.63	15.66	14.99	COFRTS5468Q12	97.81	82.13	31.04	60.69	73.66	74.84	10.76/4.00	10.20/3.78
COSWTS3680	44.00	98.13	25.87	39.22	89.81	91.00	18.86	18.04	COFRTS5468Q14	101.81	82.13	31.04	60.69	73.66	74.84	10.76/4.84	10.20/4.55
COSWTS2090	26.00	110.13	15.53	21.22	105.41	106.59	9.82	9.45	COFRTS5470Q10	93.81	86.13	32.73	60.69	77.66	78.84	11.39/3.36	10.82/3.17
COSWTS2690	32.00	110.13	19.70	27.22	104.22	105.41	13.85	13.33	COFRTS5470Q12	97.81	86.13	32.73	60.69	77.66	78.84	11.39/4.26	10.82/4.02
COSWTS2890	34.00	110.13	21.17	29.22	104.38	105.56	15.20	14.63	COFRTS5470Q14	101.81	86.13	32.73	60.69	77.66	78.84	11.39/5.16	10.82/4.87
COSWTS3090	38.00	110.13	23.86	33.22	103.44	104.63	17.88	17.21	COFRTS5480Q10	93.81	98.13	37.78	60.69	89.66	90.84	13.28/3.99	12.71/3.80
<b>3-Panel Center Operator</b>									<b>2-Panel Active, Inactive with Twin Sidelights</b>								
COSWTS7668	94.38	82.13	14.82	27.34	78.06	79.25	9.84/9.47	9.32/8.95	COFRTS5480Q12	97.81	98.13	37.78	60.69	89.66	90.84	13.28/5.05	12.71/4.81
COSWTS8068	100.38	82.13	15.88	29.34	77.94	79.13	10.80/10.23	10.23/9.79	COFRTS5480Q14	101.81	98.13	37.78	60.69	89.66	90.84	13.28/6.12	12.71/5.83
COSWTS9068	112.38	82.13	17.97	33.34	77.59	78.78	12.71/12.07	12.04/11.40	COFRTS5490Q10	93.81	110.13	42.85	60.69	101.66	102.84	15.17/4.61	14.60/4.43
COSWTS7670	94.38	86.13	15.58	27.34	82.06	83.25	10.42/10.04	9.90/9.52	COFRTS5490Q12	97.81	110.13	42.85	60.69	101.66	102.84	15.17/5.84	14.60/5.61
COSWTS8070	100.38	86.13	16.70	29.34	81.94	83.13	11.43/10.97	10.86/10.40	COFRTS5490Q14	101.81	110.13	42.85	60.69	101.66	102.84	15.17/7.08	14.60/6.79
COSWTS9070	112.38	86.13	18.89	33.34	81.59	82.78	13.45/12.81	12.78/12.14	COFRTS5608Q10	101.81	82.13	34.39	68.69	72.09	73.28	12.67/3.05	12.00/2.86
COSWTS7680	94.38	98.13	17.86	27.34	94.06	95.25	12.13/11.76	11.61/11.24	COFRTS5608Q12	105.81	82.13	34.39	68.69	72.09	73.28	12.67/3.87	12.00/3.63
COSWTS8080	100.38	98.13	19.14	29.34	93.94	95.13	13.31/12.86	12.74/12.29	COFRTS5608Q14	109.81	82.13	34.39	68.69	72.09	73.28	12.67/4.68	12.00/4.39
COSWTS9080	112.38	98.13	21.67	33.34	93.59	94.78	15.66/15.03	14.66/14.36	COFRTS5607Q10	105.81	86.13	36.30	68.69	76.09	77.28	13.41/3.26	12.74/3.07
COSWTS7690	94.38	110.13	20.14	27.34	106.06	107.25	13.85/13.48	13.33/12.96	COFRTS5607Q12	109.81	86.13	36.30	68.69	76.09	77.28	13.41/4.13	12.74/3.89
COSWTS8090	100.38	110.13	21.59	29.34	105.94	107.13	15.20/14.74	14.63/14.17	COFRTS5607Q14	109.81	86.13	36.30	68.69	76.09	77.28	13.41/5.00	12.74/4.71
COSWTS9090	112.38	110.13	24.45	33.34	105.59	106.78	17.88/17.25	17.21/16.58	COFRTS5608Q10	101.81	98.13	42.04	68.69	88.09	89.28	15.63/3.88	14.96/3.70
<b>French Door Basic Units</b>									<b>2-Panel Active, Inactive</b>								
COFRTS4068	51.19	82.13	23.53	44.50	76.16	77.34	6.96	6.60	COFRTS5609Q10	101.81	110.13	47.74	68.69	100.09	101.28	17.85/4.51	17.18/4.32
COFRTS5068	63.19	82.13	29.18	56.50	74.38	75.56	9.82	9.30	COFRTS5609Q12	105.81	110.13	47.74	68.69	100.09	101.28	17.85/5.71	17.18/5.47
COFRTS5468	67.19	82.13	30.96	60.50	73.69	74.88	10.77	10.20	COFRTS5609Q14	109.81	110.13	47.74	68.69	100.09	101.28	17.85/6.92	17.18/6.63
COFRTS6068	75.19	82.13	34.31	68.50	72.13	73.31	12.68	12.00	COFRTS7068Q10	113.81	82.13	38.84	80.69	69.31	70.50	14.79/2.73	13.97/2.53
COFRTS7068	87.19	82.13	38.93	80.50	69.63	70.82	14.80	13.98	COFRTS7068Q12	117.81	82.13	38.84	80.69	69.31	70.50	14.79/3.40	13.97/3.16
COFRTS4070	51.19	86.13	24.77	44.50	80.16	81.34	7.37	7.00	COFRTS7068Q14	121.81	82.13	38.84	80.69	69.31	70.50	14.79/4.06	13.97/3.76
COFRTS5070	63.19	86.13	30.75	56.50	78.38	79.56	10.39	9.87	COFRTS7070Q10	113.81	86.13	41.08	80.69	73.31	74.50	15.69/2.93	14.88/2.74
COFRTS5470	67.19	86.13	32.64	60.50	77.69	78.88	11.40	10.83	COFRTS7070Q12	117.81	86.13	41.08	80.69	73.31	74.50	15.69/3.67	14.88/3.42
COFRTS6070	75.19	86.13	36.21	68.50	76.13	77.31	13.41	12.75	COFRTS7070Q14	121.81	86.13	41.08	80.69	73.31	74.50	15.69/4.38	14.88/4.08
COFRTS7070	87.19	86.13	35.60	68.50	73.63	74.82	15.70	14.88	COFRTS7080Q10	113.81	98.13	47.80	80.69	85.31	86.50	18.42/3.56	17.60/3.37
COFRTS4080	51.19	98.13	28.48	44.50	92.16	93.34	8.59	8.22	COFRTS7080Q12	117.81	98.13	47.80	80.69	85.31	86.50	18.42/4.46	17.60/4.22
COFRTS5080	63.19	98.13	35.46	56.50	90.38	91.56	12.11	11.59	COFRTS7080Q14	121.81	98.13	47.80	80.69	85.31	86.50	18.42/5.33	17.60/5.04
COFRTS5480	67.19	98.13	37.68	60.50	89.69	90.88	13.29	12.71	<b>Door Transom Basic Units</b>								
COFRTS6080	75.19	98.13	41.94	68.50	88.16	89.34	15.64	14.97	<b>Single Door Transoms</b>								
COFRTS7080	87.19	98.13	40.73	68.50	85.63	86.82	18.42	18.30	CTOSWTS2018	26.00	20.0	N/A	N/A	N/A	N/A	0.89	N/A
COFRTS4090	51.19	110.13	32.18	44.50	104.16	105.34	9.81	9.44	CTOSWTS2618	32.00	20.0	N/A	N/A	N/A	N/A	1.25	N/A
COFRTS5090	63.19	110.13	40.17	56.50	102.38	103.56	13.83	13.31	CTOSWTS2818	34.00	20.0	N/A	N/A	N/A	N/A	1.37	N/A
COFRTS5490	67.19	110.13	42.72	60.50	101.69	102.88	15.71	14.60	CTOSWTS3018	38.00	20.0	N/A	N/A	N/A	N/A	1.62	N/A
COFRTS6090	75.19	110.13	47.65	68.50	100.16	101.34	17.85	17.18	CTOSWTS2026	26.00	30.0	N/A	N/A	N/A	N/A	1.90	N/A
<b>2-Panel Active, Inactive (Half Round)</b>									<b>French Door Transoms</b>								
COFRTH5080	63.19	98.13	29.59	56.50	75.41	76.59	12.06	11.54	CTOSWTS2626	32.00	30.0	N/A	N/A	N/A	N/A	2.69	N/A
COFRTH6080	75.19	98.13	33.51	68.50	72.13	73.31	15.58	14.91	CTOSWTS2826	34.00	30.0	N/A	N/A	N/A	N/A	2.95	N/A
COFRTH5090	63.19	110.13	34.30	56.50	87.41	88.59	13.78	13.26	CTOSWTS3026	38.00	30.0	N/A	N/A	N/A	N/A	3.47	N/A
COFRTH6090	75.19	110.13	40.02	68.50	84.13	85.31	17.80	17.13	<b>French Door Transoms</b>								
<b>4-Panel Units</b>									<b>CTOFRTS4018</b>								
COFRTS8068	101.56	82.13	23.62	44.69	76.13	77.31	6.96/6.40	6.59/6.03	CTOFRTS5018	63.19	20.0	N/A	N/A	N/A	N/A	3.15	N/A
COFRTS10068	125.56	82.13	29.27	56.69	74.34	75.53	9.82/8.66	9.30/8.14	CTOFRTS5418	67.19	20.0	N/A	N/A	N/A	N/A	3.39	N/A
COFRTS8070	101.56	86.13	24.87	44.69	80.13	81.31	7.37/6.81	7.00/6.44	CTOFRTS6018	75.19	20.0	N/A	N/A	N/A	N/A	3.88	N/A
COFRTS10070	125.56	86.13	30.84	56.69	78.34	79.53	10.39/9.23	9.87/8.72	CTOFRTS4026	51.19	30.0	N/A	N/A	N/A	N/A	5.18	N/A
COFRTS8080	101.56	98.13	28.59	44.69	92.13	93.31	8.58/8.03	8.22/7.66									

**UNIT SIZING, ROUGH OPENINGS  
& MASONRY OPENINGS**

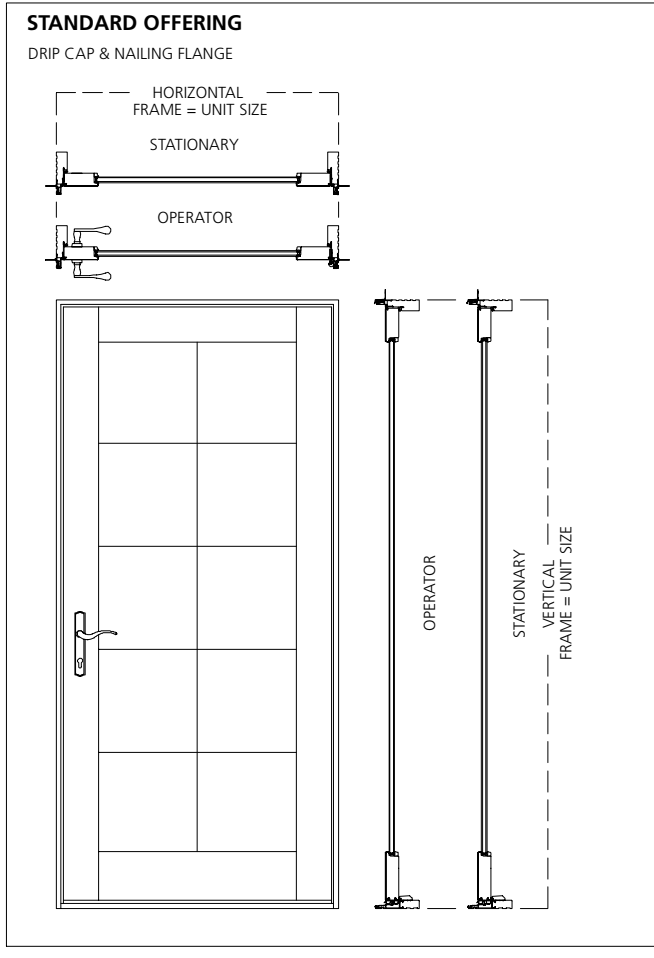

**GENERAL NOTES:**

UNITS WITH NO EXTERIOR TRIM  
OR DRIP CAP & NAILING FLANGE:  
FRAME SIZE = UNIT SIZE

UNIT SIZE IS ALWAYS THE  
EXTREME SIZE OF THE DOOR  
WITH OR WITHOUT TRIM  
(DRIP CAP & NAILING FLANGE ARE  
NOT ADDED TO ANY UNIT SIZING)

ROUGH OPENING IS ALWAYS 3/4" OVER  
FRAME SIZE OF THE DOOR

MASONRY OPENING IS ALWAYS 1/2"

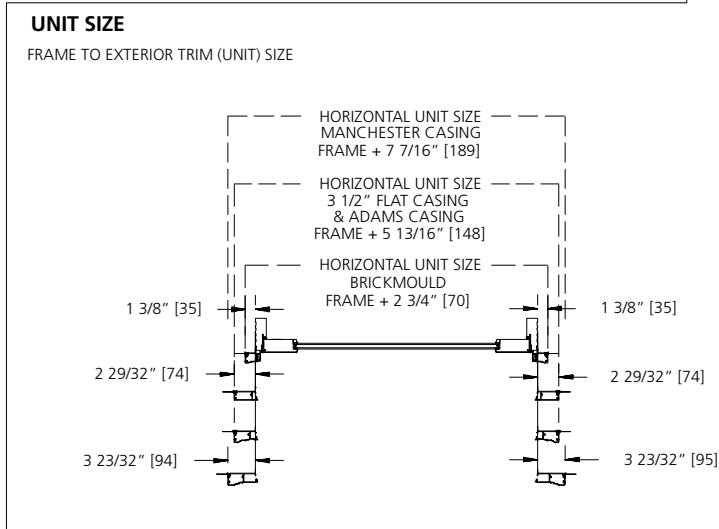
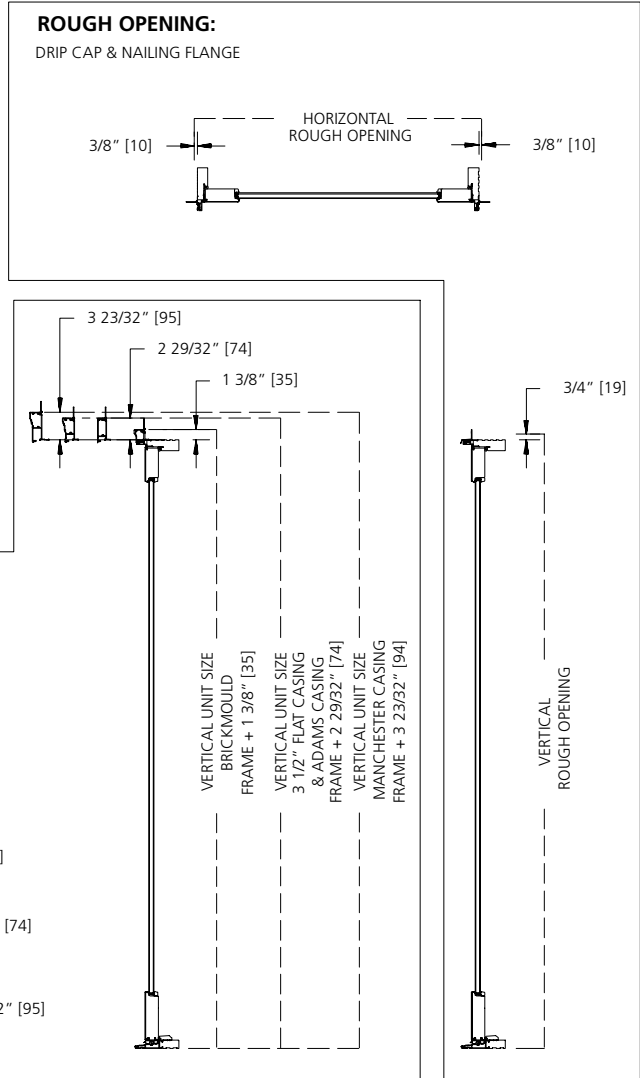



**1-PANEL OPERATING UNIT**

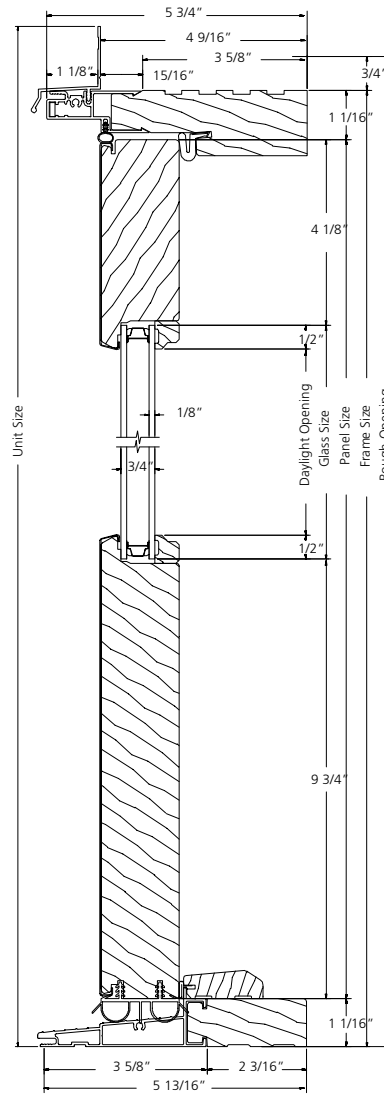

**VERTICAL SECTION**

SCALE: 3" = 1'

**1-PANEL OPERATING UNIT**

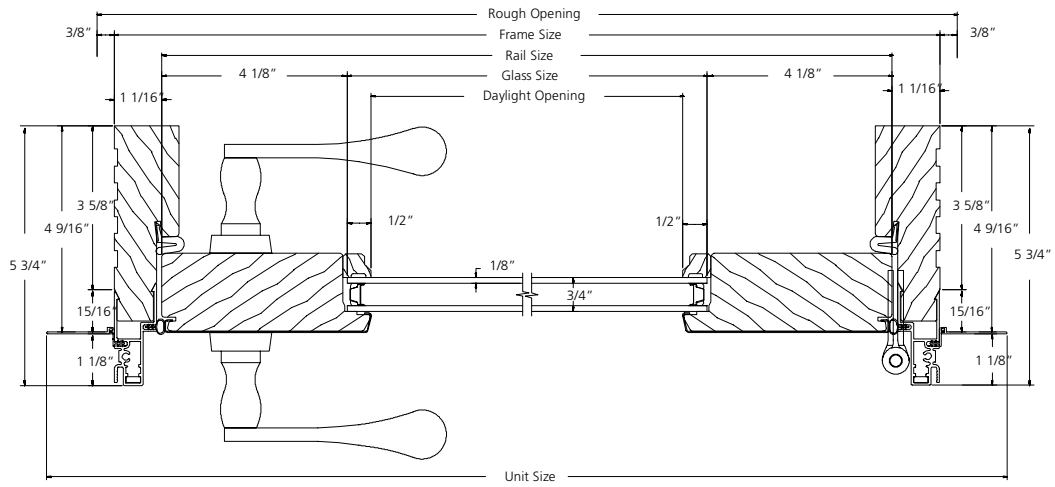

**HORIZONTAL SECTION**

SCALE: 3" = 1'

**2-PANEL UNIT**

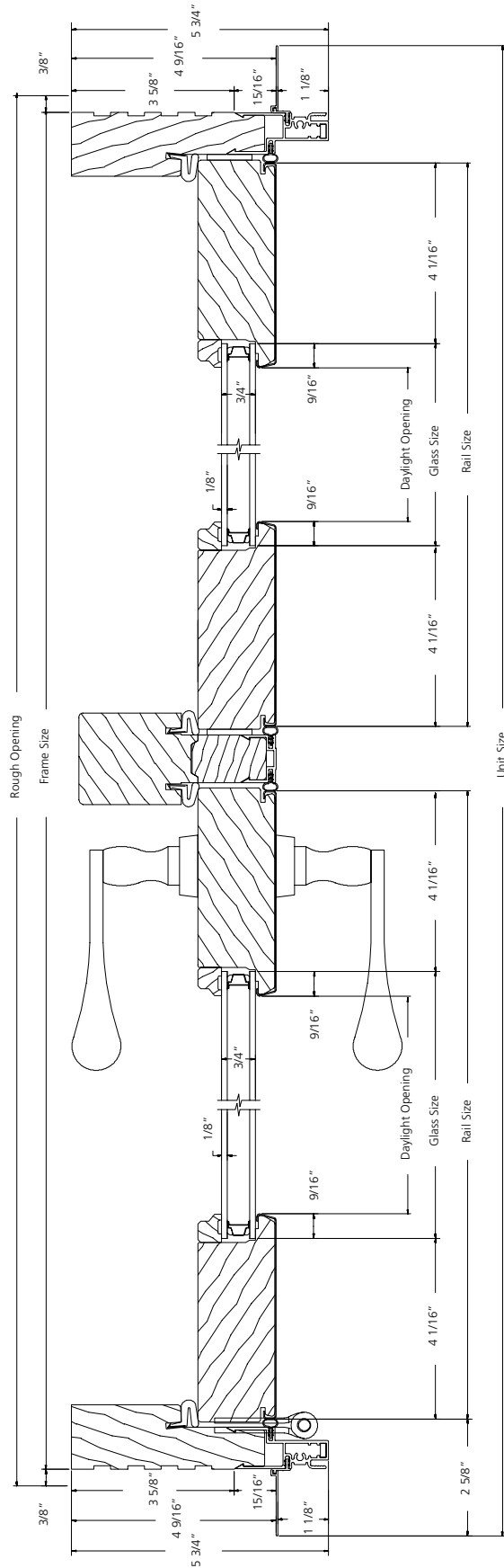

**HORIZONTAL SECTION**

SCALE: 3" = 1'

**3-PANEL UNIT**

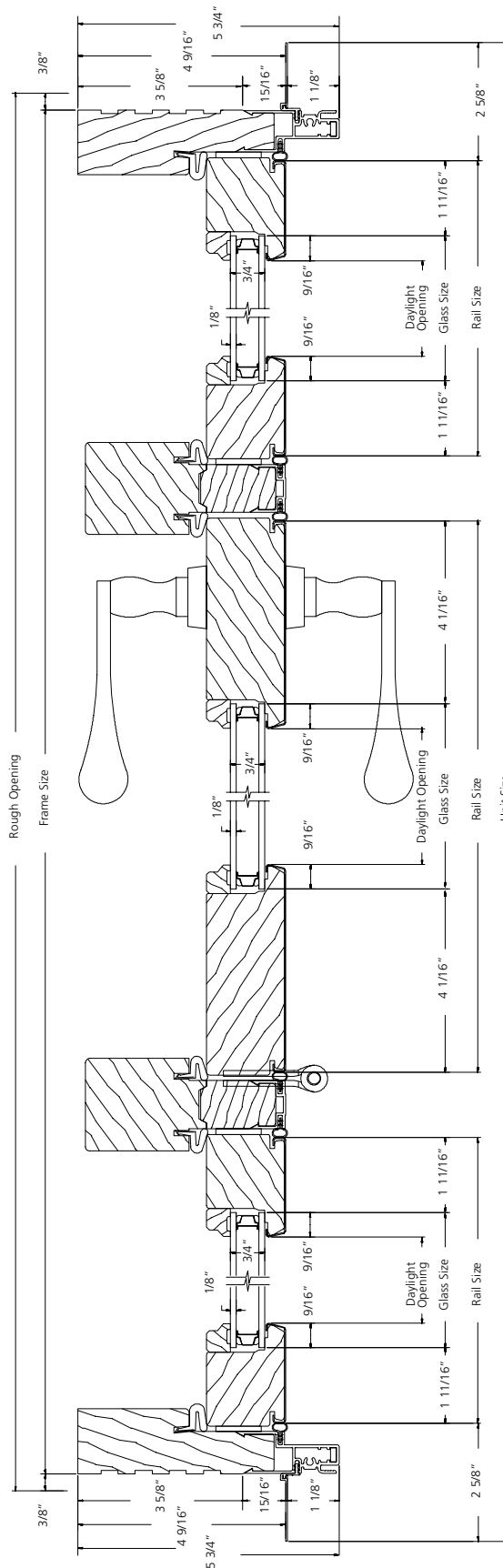

**HORIZONTAL SECTION**

SCALE: 3" = 1'

**2-PANEL FRENCH UNIT**

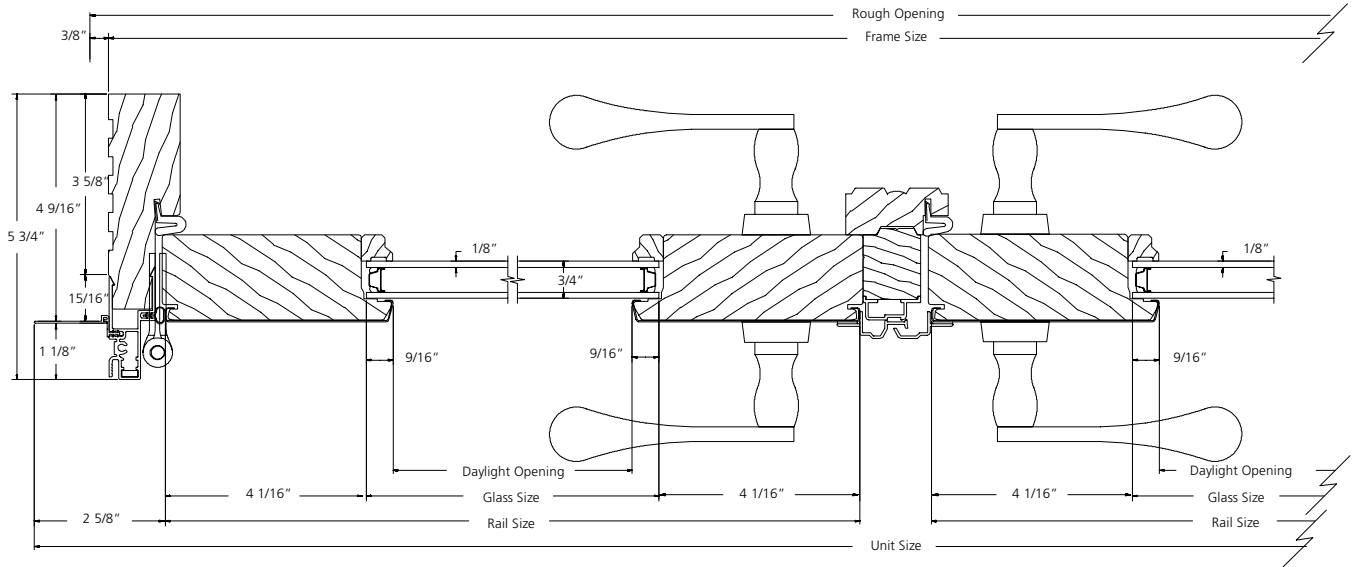

**HORIZONTAL SECTION**

SCALE: 3" = 1'

**4-PANEL FRENCH UNIT**

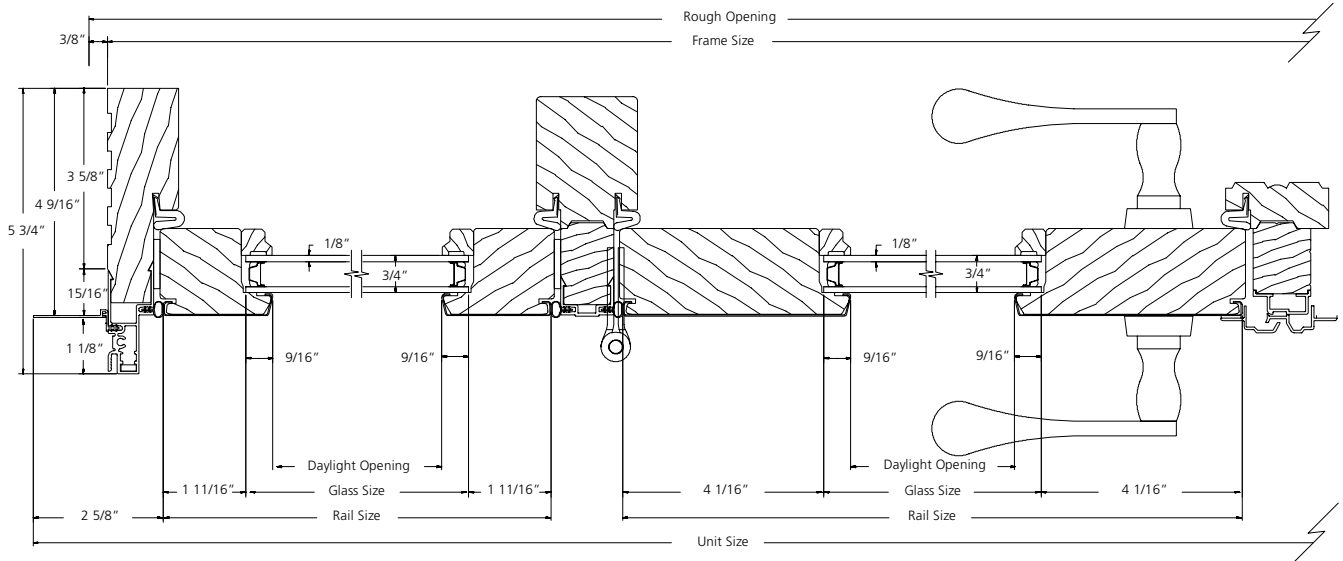

**HORIZONTAL SECTION**

SCALE: 3" = 1'

**STATIONARY UNIT WITH SIDELIGHT**

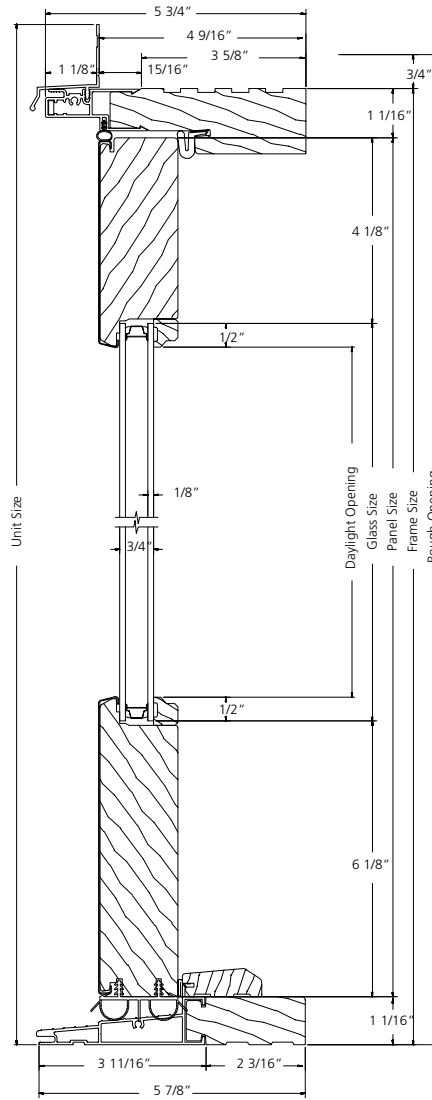

**VERTICAL SECTION**

SCALE: 3" = 1'

**STATIONARY UNIT WITH SIDELIGHT**

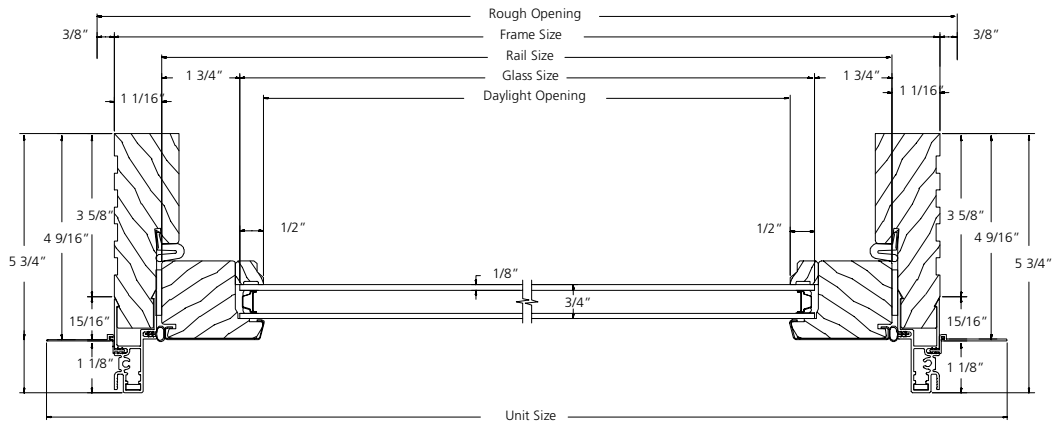

**HORIZONTAL SECTION**

SCALE: 3" = 1'



**SINGLE SASH TRANSOM  
WITH 4-9/16" JAMB**

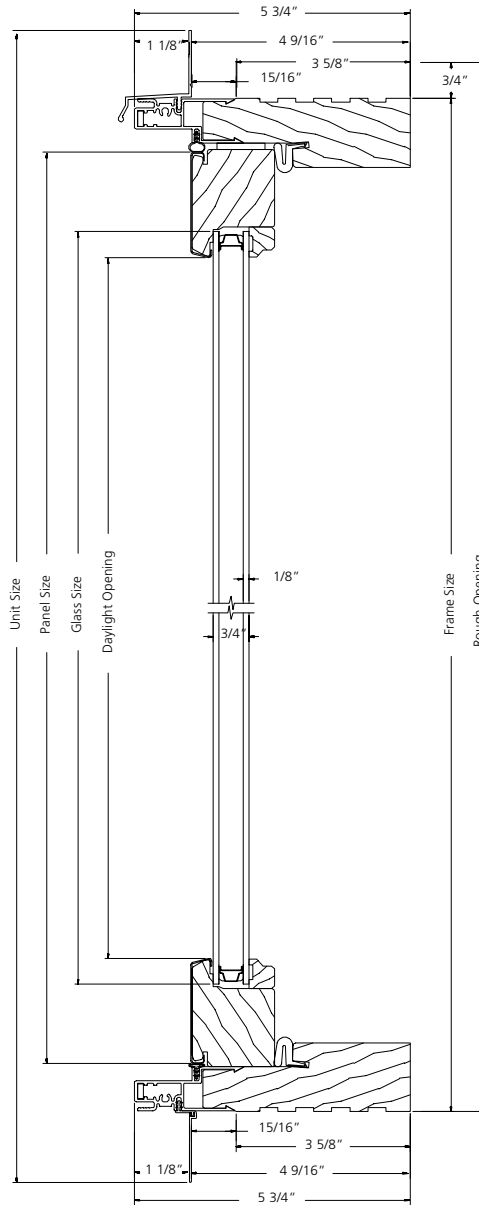

**VERTICAL SECTION**

SCALE: 3" = 1'

**SINGLE SASH TRANSOM  
WITH 6-916" JAMB**

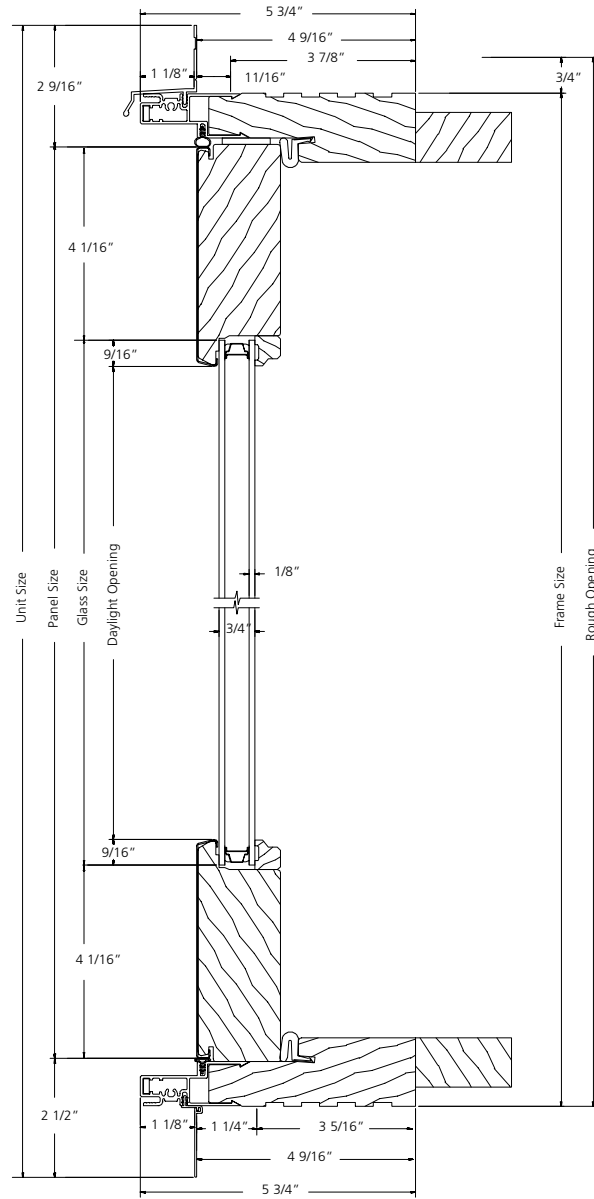

**VERTICAL SECTION**

SCALE: 3" = 1'

**SINGLE SASH TRANSOM**

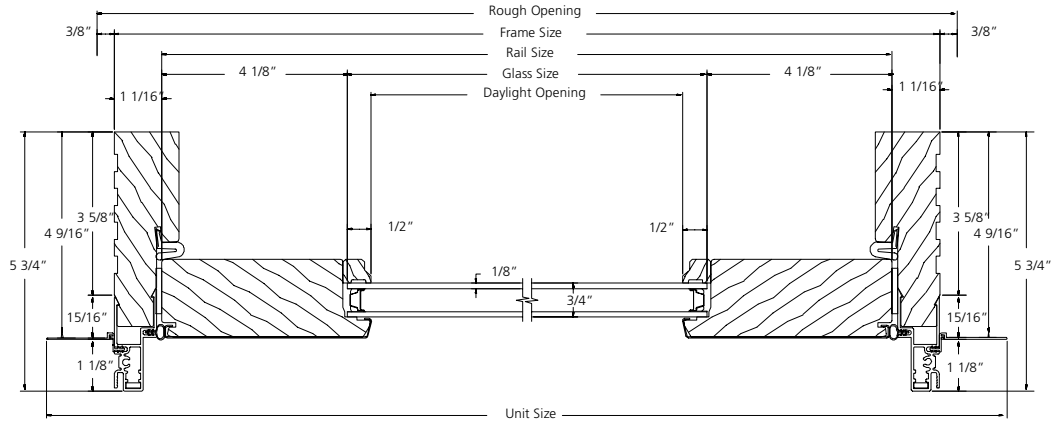

**HORIZONTAL SECTION**

SCALE: 3" = 1'

**MULTI-SASH TRANSOM**

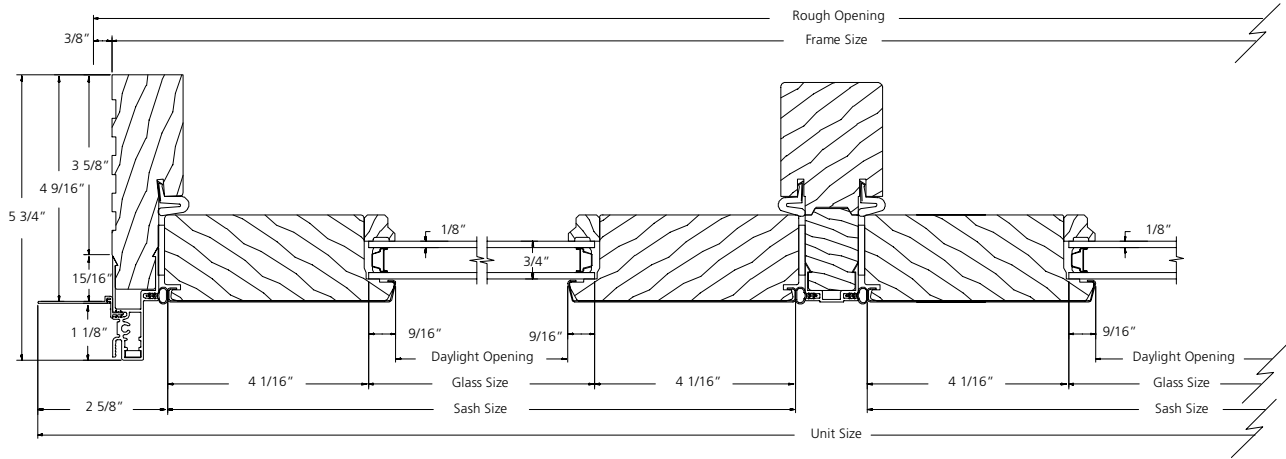

**HORIZONTAL SECTION**

SCALE: 3" = 1'