

---

TABLE OF CONTENTS

---

Specifications .....	15-2
Quick Spec Guide .....	15-4
Elevations: 1/4" Scale .....	15-6
Swinging Door Units .....	15-8
French Units .....	15-11
Single Door with Single Sidelite .....	15-13
Single Door with Two Sidelites .....	15-14
French Door with Two Sidelites .....	15-15
Transom Units .....	15-19
Sector Top Doors .....	15-24
French Sector Top Doors .....	15-26
French Sector Top Doors with Two Sidelites .....	15-28
Sector Top Transom Units .....	15-32
Glazing Options .....	15-33
Trim Options .....	15-36
Rail, Panel & Sill Options .....	15-37
Mullion Details .....	15-41
Grille & SDL Patterns .....	15-42
Clear Opening and Daylight Specifications .....	15-43
Unit Sizing, Rough Openings & Masonry Openings .....	15-48
Section Details: 3" Scale .....	15-49

**PRODUCT SPECIFICATIONS****EXTERIOR FINISH**

Exterior aluminum surfaces are finished with a fluoropolymer (70% Kynar 500®) multi-coat finish system to meet the performance standards required by AAMA specification #2605. Standard colors include Brilliant White, Chestnut Bronze, Desert Sand, French Vanilla, Hartford Green, Mesa Red, Black Licorice, Heirloom White, Hunter Green, Redwood, Sage Brown, and Smoke. Options include 27 Luxury Colors, Custom Color Matching and Clear Satin Anodized finish. Three copper finishes are available on door panels.

**AURALAST® WOOD**

AuraLast® wood is fundamentally different from wood treated in traditional millwork preservation processes in that it uses a proprietary vacuum/pressure process to provide protection throughout the wood parts used to make windows and doors. AuraLast® wood is distinguished from wood using traditional preservation methods by its unique ability to achieve greater penetration of the active ingredients into the wood parts, with a minimum treatment penetration of 92%.

**INTERIOR FINISH**

Interior surfaces are unfinished clear pine ready for on-site finishing. Optional prefinished pine interiors include four acrylic colors (Moderate White, Extra White, Natural Choice, Pure White), four stains (Wheat, Cherry, Fruitwood, Cordovan) and a clear lacquer topcoat. Primed interior is also available. Optional interior wood species include vertical grain Douglas Fir, Mahogany and Pacific Coast Red Alder.

**FRAME**

Frame is assembled from select kiln-dried pine AuraLast® wood on all exterior parts. Exterior surface is covered with .050 gauge extruded aluminum cladding. Standard jamb width is 4-9/16". Radius frames are produced in only three different radii: 90-9/32", 37-19/16", and 31-19/32".

**PANELS**

1-23/32" thick select kiln-dried pine AuraLast® wood. Exterior surface is covered with .024 gauge roll formed aluminum cladding. The top and bottom rails are formed from solid Western Pine veneers laminated to a kiln dried edge-and-end-glued core, while the stiles have the same veneer laminated to a Timberstrand core. The standard layout is 4-5/8" top rail and stiles and a 6-5/8" bottom rail. Other door rail options include wide bottom rail, lock rail and raised panels.

**GLAZING**

Insulating glass is constructed from two panes of tempered glass, utilizing a continuous roll formed stainless steel spacer with dual seal sealant. A computer-controlled application of clear silicone is used to bed the exterior of the insulating glass into the panel. An acrylic sealant is used to bed the interior. All insulating glass units comply with the performance requirements of IGCC in accordance with either ASTM E774 or E2190.

**GLAZING OPTIONS - TEMPERED**

Tempered insulating glass available in Low-E with Argon, Low-E, Low-E 366, Clear, Neat Glass, Seedy Reamy, tinted, reflective, or obscure, or other specialty glass as specified. Preserve® film is a 0.003" thick polyethylene film with a low tack acrylic adhesive applied to the glass for protection during shipping and installation. Installations at 4,000 foot elevations and higher require a capillary tube to equalize environmental stress (otherwise known as High Altitude glazing). High altitude glazing does not allow the use of Argon as listed under glazing options

**WEATHER-STRIPPING**

Engineered system with dual foam filled bulb seal compressed between the exterior of the panel and the frame in a continuous plane on all four sides.

**SILL**

The sill is a dark bronze anodized aluminum with interior trim and an adjustable composite threshold in combination with a vinyl fin-and-bulb bottom door sweep. An optional handicapped sill with a maximum height of 1/2" is available to meet the standards set forth by the ADA for handicapped access.

**HARDWARE**

The door panels are mounted into the frame utilizing 4" x 4" heavy gauge solid brass hinges with stainless steel pins. Three hinges are used on 6-8 and 7-0 heights, and four hinges on all larger heights. Optional adjustable hinges are also available providing both vertical and horizontal adjustment. The standard finish for all hinges is Polished Brass, with optional finishes available in Antique Brass, Polished Chrome, Stainless Steel Satin, Oil Rubbed Bronze, White Powder Coat, and Black Powder Coat, Brushed Chrome, and PVD Brass. The standard locking system is a single point mortise with lever handle, and thumb turn dead bolt, shipped separately for field installation. Matching dummy handle sets are included for French Door applications. Optional multipoint lock systems are factory installed securing the active panel at three points. The system is manually activated from the handle.

**INSECT SCREENS**

Optional exterior sliding screen is assembled with 18 x 16 fiberglass mesh screen cloth set in an extruded aluminum frame supplied with all necessary hardware. Standard colors are Brilliant White, Chestnut Bronze, Desert Sand, French Vanilla, Hartford Green, Mesa Red, Black Licorice, Heirloom White, Hunter Green, Redwood, Sage Brown, and Smoke. Screens not available for Single Swing, French or Radius doors. Insect screens are intended to allow air and light in and to keep insects out. They are not intended to keep anyone or anything from falling through an open window. For safety screens or other security devices contact your local building supply retailer.

**GRILLES**

**SDL** (Simulated Divided Lites) - extruded aluminum muntins permanently applied to the exterior of the insulating glass unit (not available on textured glass) in 7/8", 1-1/8", or 1-3/8" widths. Profiles are bead stop in all widths, and a putty profile in the 7/8" and 1-1/8" widths only. 1" Copper SDL is also available. SDL is standard with a light bronze internal shadow bar to give a true divided lite appearance. As an option, SDL may be ordered with a silver shadow bar or without a shadow bar. Clear wood interior muntin bars match the exterior muntin width and are permanently bonded to the interior of the glass. Also available is a 2-5/16" SDL bar, which simulates a double-hung checkrail.

**Full Surround Removable Wood Grilles** - Rectangular, unfinished interior clear pine wood grilles in 7/8", 1-1/8", and 1-3/8" are available in patterns selected by the owner.

**GBG** (Grilles between the Glass) - 5/8" flat, 23/32" contour, or 1" contour grilles mounted between the glass panes suspended within the air cavity.

*Continued on next page*

---

**PRODUCT SPECIFICATIONS**

---

**EXTERIOR TRIM**

Nail flange and drip cap standard with optional extruded aluminum brickmould, 3-1/2" flat, 3-1/2" Adams and Manchester trims. Optional mull covers to accommodate 1" (spread only), 2", 3-1/2" and 6" spread and stud pocket mull.

**EXTENSION JAMBS**

Extension jambs are available for wall depths up to 6-11/16".

**INSTALLATION**

Installation per JELD-WEN Installation Method for Metal Clad Patio Doors. See [www.jeld-wen.com/resources](http://www.jeld-wen.com/resources) for instructions.

**PERFORMANCE**

**NFRC Certified** - (rated and labeled in accordance with NFRC 100 and 200 procedures)

**ANSI/AAMA/NWDA/101/I.S.2-97**  
**AMMA/WDMA/CSA 101/I.S.2/A440-05**  
**WDMA Hallmark Certified**

See [www.jeld-wen.com](http://www.jeld-wen.com) for architectural and performance information.

**QUICK SPEC GUIDE**

SPECIFICATION	STANDARD FEATURES	OPTIONAL FEATURES <i>Some options may require additional lead times. Consult your JELD-WEN Sales Representative.</i>				
<b>EXTERIOR FINISH</b>	<ul style="list-style-type: none"> <li>• Brilliant White</li> <li>• Chestnut Bronze</li> <li>• Desert Sand</li> <li>• French Vanilla</li> <li>• Mesa Red</li> <li>• Hartford Green</li> <li>• Black Licorice</li> <li>• Heirloom White</li> <li>• Hunter Green</li> <li>• Redwood</li> <li>• Sage Brown</li> <li>• Smoke</li> </ul>	<ul style="list-style-type: none"> <li>• Black Emerald</li> <li>• Bone White</li> <li>• Bronze</li> <li>• Buckskin</li> <li>• Cambridge White</li> <li>• Capri Blue</li> <li>• Cascade</li> <li>• Champagne</li> <li>• Clover Mist</li> <li>• Dark Buckskin</li> <li>• Dark Ivy</li> <li>• Deep Summer</li> <li>• Garnet</li> <li>• Haverstraw</li> <li>• Hudson Blue</li> <li>• Ivory</li> <li>• Ivy</li> <li>• Liberty Blue</li> <li>• Mocha Cream</li> <li>• Mosaic Green</li> <li>• Pueblo Tan</li> <li>• Rosewood</li> <li>• Scarlet Haze</li> <li>• Sea Foam</li> <li>• Teal</li> <li>• Wedgewood</li> <li>• White</li> <li>• Clear Satin Anodized</li> <li>• Custom Color Matching</li> </ul> <div style="border: 1px solid black; padding: 5px; margin-top: 10px;"> <p>Panel Only:</p> <ul style="list-style-type: none"> <li>• Bright Copper</li> <li>• Speckled Patina Copper</li> <li>• Hand Rubbed Patina Copper</li> </ul> </div>				
<b>EXTERIOR TRIM</b>	<ul style="list-style-type: none"> <li>• Drip Cap &amp; Nailing Fin</li> </ul>	<ul style="list-style-type: none"> <li>• Extruded Aluminum Brickmould</li> <li>• Adams Casing</li> <li>• 3-1/2" Flat Casing</li> <li>• Manchester Casing</li> <li>• Folding Nailing Fin</li> </ul>				
<b>INTERIOR WOOD</b>	<ul style="list-style-type: none"> <li>• Western Pine</li> </ul>	<ul style="list-style-type: none"> <li>• Pacific Coast Red Alder</li> <li>• Vertical Grain Douglas Fir</li> <li>• Mahogany</li> </ul>				
<b>INTERIOR FINISH</b>	<ul style="list-style-type: none"> <li>• Natural</li> </ul>	<ul style="list-style-type: none"> <li>• Priming Available</li> </ul> <p>Pre-finished Interior Options are:</p> <ul style="list-style-type: none"> <li>• Paint - Pure White, Extra White, Natural Choice, Moderate White</li> <li>• Stain - Wheat, Fruitwood, Cherry, Cordovan</li> <li>• Clear Lacquer</li> </ul>				
<b>SIZE</b>	<ul style="list-style-type: none"> <li>• Width: 2-0, 2-6, 2-8, 3-0, 3-6, 4-0, 5-0, 5-4, 6-0, 7-6, 8-0, 9-0, 10-0, 12-0</li> <li>• Height: 6-8, 7-0, 8-0, 9-0</li> </ul>	<ul style="list-style-type: none"> <li>• Any Panel Width: 2-0 to 3-6 (Certain restrictions apply)</li> <li>• Any Panel Height: 4-0 to 10-0 (Certain restrictions apply)</li> </ul>				
<b>GLAZING (ALL TEMPERED)</b>	<ul style="list-style-type: none"> <li>• Low-E Tempered Insulating Glass (with Argon)</li> <li>• Preserve® Protective Film</li> </ul>	<table style="width: 100%; border-collapse: collapse;"> <tr> <td style="vertical-align: top;"> <ul style="list-style-type: none"> <li>• Clear</li> <li>• Low-E 366</li> <li>• Obscure</li> <li>• Tints: Bronze, Gray, Solex</li> <li>• Reflective: Bronze and Gray</li> <li>• Glue Chip</li> </ul> </td> <td style="vertical-align: top;"> <ul style="list-style-type: none"> <li>• Safety Laminated in Clear, Bronze or Gray</li> <li>• Neat Glass</li> <li>• Seedy Reamy</li> <li>• Rain</li> <li>• Narrow Reed</li> <li>• Impact Resistant</li> </ul> </td> </tr> <tr> <td colspan="2" style="padding-top: 10px;"> <ul style="list-style-type: none"> <li>• High Altitude (Breather Tube, no Argon)</li> </ul> </td> </tr> </table>	<ul style="list-style-type: none"> <li>• Clear</li> <li>• Low-E 366</li> <li>• Obscure</li> <li>• Tints: Bronze, Gray, Solex</li> <li>• Reflective: Bronze and Gray</li> <li>• Glue Chip</li> </ul>	<ul style="list-style-type: none"> <li>• Safety Laminated in Clear, Bronze or Gray</li> <li>• Neat Glass</li> <li>• Seedy Reamy</li> <li>• Rain</li> <li>• Narrow Reed</li> <li>• Impact Resistant</li> </ul>	<ul style="list-style-type: none"> <li>• High Altitude (Breather Tube, no Argon)</li> </ul>	
<ul style="list-style-type: none"> <li>• Clear</li> <li>• Low-E 366</li> <li>• Obscure</li> <li>• Tints: Bronze, Gray, Solex</li> <li>• Reflective: Bronze and Gray</li> <li>• Glue Chip</li> </ul>	<ul style="list-style-type: none"> <li>• Safety Laminated in Clear, Bronze or Gray</li> <li>• Neat Glass</li> <li>• Seedy Reamy</li> <li>• Rain</li> <li>• Narrow Reed</li> <li>• Impact Resistant</li> </ul>					
<ul style="list-style-type: none"> <li>• High Altitude (Breather Tube, no Argon)</li> </ul>						

*Continued on next page*

**QUICK SPEC GUIDE**

SPECIFICATION	STANDARD FEATURES	OPTIONAL FEATURES <i>Some options may require additional lead times. Consult your JELD-WEN Sales Representative.</i>
<b>GRILLES</b>		<ul style="list-style-type: none"> <li>• 1" Copper SDL</li> </ul> <p>SDL Bead Profile:</p> <ul style="list-style-type: none"> <li>• 7/8", 1-1/8", 1-3/8", 2-5/16" with Light Bronze Shadow Bar</li> <li>• 7/8", 1-1/8", 1-3/8", 2-5/16" with Silver Shadow Bar</li> <li>• 7/8", 1-1/8", 1-3/8", 2-5/16" with No Shadow Bar</li> </ul> <p>SDL Putty Profile:</p> <ul style="list-style-type: none"> <li>• 7/8" and 1-1/8" with Light Bronze Shadow Bar</li> <li>• 7/8" and 1-1/8" with Silver Shadow Bar</li> <li>• 7/8" and 1-1/8" with No Shadow Bar</li> </ul> <ul style="list-style-type: none"> <li>• 1" Copper SDL</li> </ul> <p>GBG (Grilles between the Glass):</p> <ul style="list-style-type: none"> <li>• 5/8" Flat, 23/32" Contour, 1" Contour</li> </ul> <p>Full Surround:</p> <ul style="list-style-type: none"> <li>• 7/8", 1-1/8", 1-3/8" Wood Grilles</li> </ul>
<b>HARDWARE</b>	<ul style="list-style-type: none"> <li>• 4 x 4 Heavy Gauge Hinges</li> <li>• Single Point Mortise Lock with Lever Handle</li> </ul>	<ul style="list-style-type: none"> <li>• Adjustable Hinges</li> <li>• Multipoint Manually Activated Lock</li> </ul>
<b>HARDWARE COLOR</b>	<ul style="list-style-type: none"> <li>• Polished Brass</li> </ul>	<ul style="list-style-type: none"> <li>• Antique Brass</li> <li>• Polished Chrome</li> <li>• Brushed Chrome</li> <li>• Oil Rubbed Bronze</li> <li>• White Powder Coat</li> <li>• Black Powder Coat</li> </ul>
<b>JAMB</b>	<ul style="list-style-type: none"> <li>• Applied, 5/4</li> <li>• 4-9/16"</li> </ul>	<ul style="list-style-type: none"> <li>• 4-11/16"* , 6-9/16" and 6-11/16"*</li> </ul> <p>*Only available with Folding Nailing Flange option</p>
<b>INSECT SCREENS</b>		<ul style="list-style-type: none"> <li>• Fiberglass</li> </ul>
<b>SCREEN FRAME COLOR</b>	<ul style="list-style-type: none"> <li>• Brilliant White</li> <li>• Chestnut Bronze</li> <li>• Desert Sand</li> <li>• French Vanilla</li> <li>• Mesa Red</li> <li>• Hartford Green</li> <li>• Black Licorice</li> <li>• Heirloom White</li> <li>• Hunter Green</li> <li>• Redwood</li> <li>• Sage Brown</li> <li>• Smoke</li> </ul>	<ul style="list-style-type: none"> <li>• Black Emerald</li> <li>• Bone White</li> <li>• Bronze</li> <li>• Buckskin</li> <li>• Cambridge White</li> <li>• Capri Blue</li> <li>• Cascade</li> <li>• Champagne</li> <li>• Clover Mist</li> <li>• Dark Buckskin</li> <li>• Dark Ivy</li> <li>• Deep Summer</li> <li>• Garnet</li> <li>• Haverstraw</li> <li>• Hudson Blue</li> <li>• Ivory</li> <li>• Ivy</li> <li>• Liberty Blue</li> <li>• Mocha Cream</li> <li>• Mosaic Green</li> <li>• Pueblo Tan</li> <li>• Rosewood</li> <li>• Scarlet Haze</li> <li>• Sea Foam</li> <li>• Teal</li> <li>• Wedgewood</li> <li>• White</li> <li>• Clear Satin Anodized</li> <li>• Custom Color Matching</li> </ul>

**GENERAL INFORMATION**

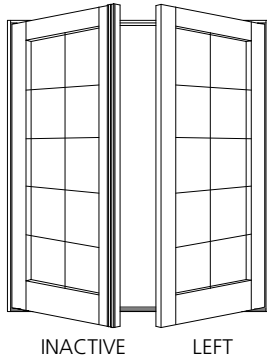

**DIMENSIONAL DOORS**

Clad in-swing patio doors may be specified as "dimensional" by adjusting the desired rough opening width or height in 1/4" increments from standard.

Clad in-swing patio doors are available in single, twin, triple, and quad panel doors. Transoms are available to match the variety of door sizes. The standard size range includes sizes specifically designed for replacement of older patio door models in existing structures, as well as a full range of "true size" products for architectural consistency.

**OPERATION**

Clad in-swing patio doors are available in a full range of operating styles. Single panel doors may be specified as stationary (non-venting) or can operate left or right. Center swing two- or three-panel doors are available with left or right operation. French doors feature two operating panels (one active, which opens first; and one inactive, which closes first), and are available in two-panel and four-panel styles. Configuration and handing is based on viewing the door from the interior.

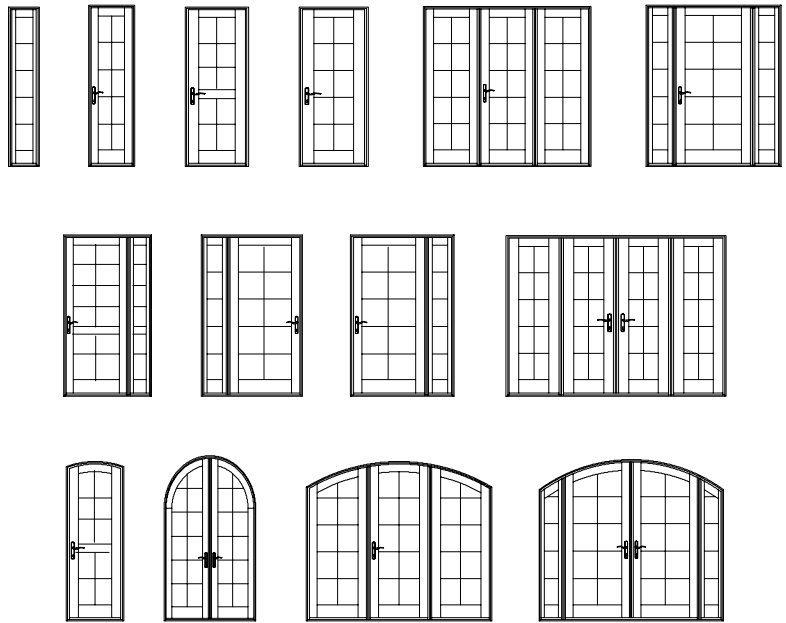

**MULTIPLE ASSEMBLIES**

Clad in-swing patio doors are available in a wide variety of multiple panel configurations from the factory, all of which are assembled with continuous sills. Clad In-Swing patio doors may be mullered below, or beside other wood door and wood window products. Factory assembled mulls are limited in height (100"), width (150"), and a total area (75 square feet).



**ELEVATION NOTES**

ELEVATION DRAWINGS UTILIZE A LIMITED NUMBER OF PROJECTED LINES TO PRODUCE A RUDIMENTARY DRAWING INTENDED TO BE USED IN A SMALL GRAPHICAL SCALE. ELEVATIONS ARE VIEWED PERPENDICULAR FROM THE EXTERIOR OF THE STRUCTURE. IF MORE DIMENSIONS ARE NEEDED, USE THE SECTION DRAWINGS FOR MORE COMPLETE DEPICTIONS.

M.O. Brickmould	40 11/16" [ 1033 ]	
M.O. Adams/Flat Casing	43 3/4" [ 1111 ]	
Rough Opening	38 3/16" [ 970 ]	
Frame Size	37 7/16" [ 951 ]	
Daylight Opening	26 5/8" [ 676 ]	

Masonry Openings for Brickmould, Flat & Adams Casing. Vertical measurements for transoms include sill nose. (Subtract 1/2" from Masonry Opening for Unit Size)

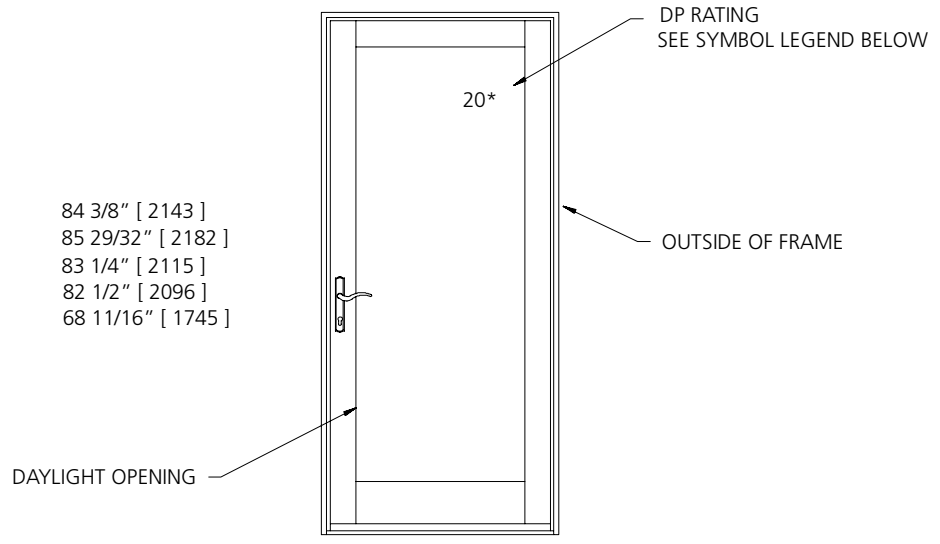

**CISWT3068**

'CISW' INDICATES CLAD INSWING PATIO DOOR  
'CIFR' INDICATES CLAD INSWING FRENCH DOOR  
'T' INDICATES 'TRUE SIZE',  
'R' INDICATES 'RETRO SIZE'

BOOK CODE  
THE LAST TWO NUMBERS INDICATE THE UNIT HEIGHT  
THE FIRST TWO NUMBERS INDICATE THE UNIT WIDTH

**GENERAL SWINGING DOOR NOTES**

1. CLAD IN-SWING PATIO DOOR (CISW / CIFR) UNITS ARE AVAILABLE AS OPERATING OR STATIONARY UNITS.
2. UNIT ELEVATIONS ARE SHOWN WITHOUT EXTERIOR TRIM. UNIT SIZES & MASONRY OPENING DIMENSIONS WILL CHANGE WITH THE ADDITION OF EXTERIOR TRIM. SEE THE 'UNIT SIZING, ROUGH OPENINGS & MASONRY OPENINGS' PAGE FOR EXTERIOR TRIM EFFECTS.
3. OPERATING UNITS ARE AVAILABLE AS LEFT OR RIGHT HAND OPERATION.
4. HANDICAP SILL, 10 1/4" BOTTOM RAILS, INTERMEDIATE LOCK RAILS AND RAISED PANELS ARE AVAILABLE FOR ALL UNITS.

**ELEVATION SYMBOL LEGEND:**

- S** PANEL IS AVAILABLE AS STATIONARY ONLY.
- ###** NUMBER INDICATES DESIGN PRESSURE (DP) RATING WITH STANDARD GLAZING. OPERATING UNITS UTILIZE MULTI-POINT LOCKING HARDWARE FOR DP RATINGS.

### 1-PANEL UNITS

**M.O. BRICKMOULD**  
**M.O. ADAMS/FLAT CASING**  
**ROUGH OPENING**  
**FRAME SIZE**  
**DAYLIGHT OPENING**

26 11/16" [678] 32 11/16" [830] 34 11/16" [881] 38 11/16" [983]  
 29 3/4" [756] 35 3/4" [908] 37 3/4" [959] 41 3/4" [1060]  
 24 3/16" [614] 30 3/16" [767] 32 3/16" [818] 36 3/16" [919]  
 23 7/16" [595] 29 7/16" [748] 31 7/16" [799] 35 7/16" [900]  
 12 5/8" [321] 18 5/8" [473] 20 5/8" [524] 24 5/8" [625]

81 3/8" [2067]  
 82 7/8" [2105]  
 80 1/4" [2038]  
 79 1/2" [2019]  
 65 11/16" [1668]

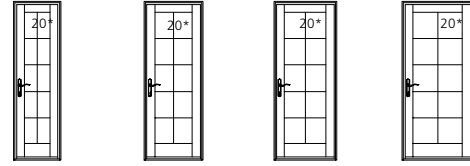

97 3/8" [2473]  
 98 7/8" [2511]  
 96 1/4" [2445]  
 95 1/2" [2426]  
 81 11/16" [2075]

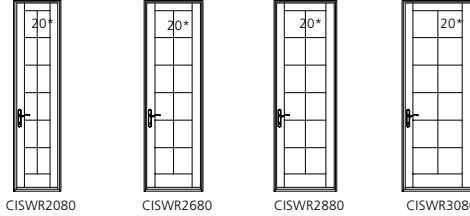

109 3/8" [2778]  
 110 7/8" [2816]  
 108 1/4" [2750]  
 107 1/2" [2731]  
 93 11/16" [2380]

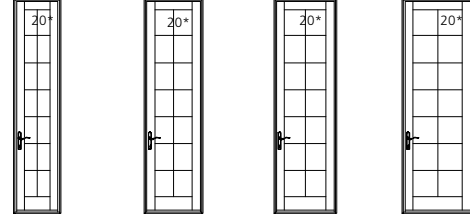

**ELEVATION SYMBOL LEGEND:**

**M.O.** = MASONRY OPENING  
 VALUES IN [ ] ARE IN MILLIMETER CONVERSIONS  
**S** PANEL IS AVAILABLE AS STATIONARY ONLY.  
**##** = NUMBER INDICATES DESIGN PRESSURE (DP) RATING WITH STANDARD GLAZING. OPERATING UNITS UTILIZE MULTI-POINT LOCKING HARDWARE FOR DP RATINGS.

Note: Elevations shown DO NOT have exterior trim. Subtract 1/2" (12.7) from M.O. (Masonry Opening) for Unit Size. For other Trim Options refer to the Unit Sizing, Rough Opening & Masonry Openings page.

**M.O. BRICKMOULD**  
**M.O. ADAMS/FLAT CASING**  
**ROUGH OPENING**  
**FRAME SIZE**  
**DAYLIGHT OPENING**

16 13/16" [427] 18 13/16" [478] 20 13/16" [529] 28 11/16" [729] 34 11/16" [881] 36 11/16" [932] 40 11/16" [1033] 46 11/16" [1186]  
 19 7/8" [505] 21 7/8" [556] 23 7/8" [606] 31 3/4" [806] 37 3/4" [959] 39 3/4" [1010] 43 3/4" [1111] 49 3/4" [1264]  
 14 5/16" [364] 16 5/16" [414] 18 5/16" [465] 26 3/16" [665] 32 3/16" [818] 34 3/16" [868] 38 3/16" [970] 44 3/16" [1122]  
 13 9/16" [344] 15 9/16" [395] 17 9/16" [446] 25 7/16" [646] 31 7/16" [799] 33 7/16" [849] 37 7/16" [951] 43 7/16" [1103]  
 7 1/2" [190] 9 1/2" [241] 11 1/2" [292] 14 5/8" [371] 20 5/8" [524] 22 5/8" [575] 26 5/8" [676] 32 5/8" [829]

84 3/8" [2143]  
 85 7/8" [2181]  
 83 1/4" [2115]  
 82 1/2" [2096]  
 68 11/16" [1745]

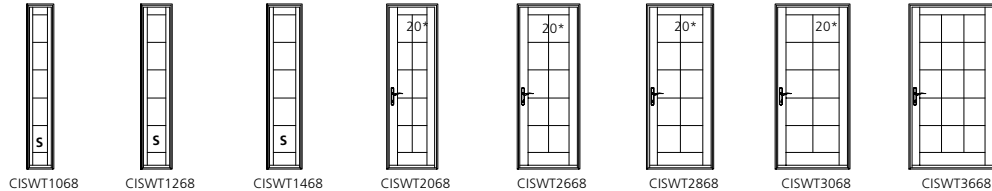

88 3/8" [2245]  
 89 7/8" [2283]  
 87 1/4" [2216]  
 86 1/2" [2197]  
 72 11/16" [1846]

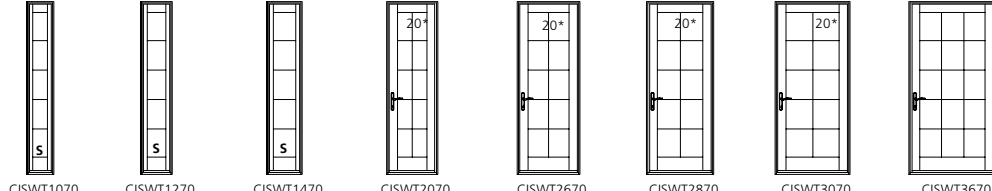

100 3/8" [2550]  
 101 7/8" [2588]  
 99 1/4" [2521]  
 98 1/2" [2502]  
 84 11/16" [2151]

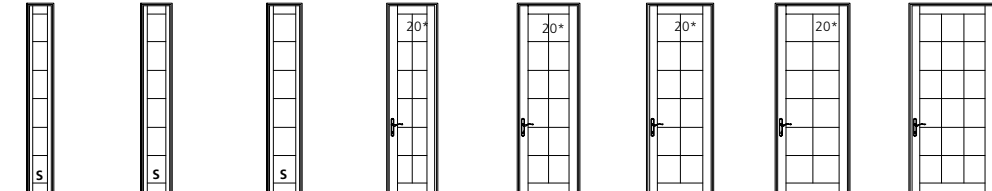

112 3/8" [2854]  
 113 7/8" [2892]  
 111 1/4" [2826]  
 110 1/2" [2807]  
 96 11/16" [2456]

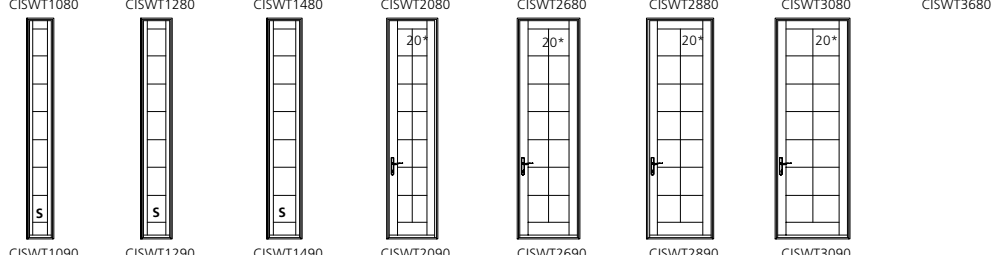

SCALE: 1/8" = 1'



**2-PANEL UNITS**

**M.O. BRICKMOULD  
M.O. ADAMS/FLAT CASING  
ROUGH OPENING  
FRAME SIZE  
DAYLIGHT OPENING**

61 7/8" [1572]  
64 15/16" [1649]  
59 3/8" [1508]  
58 5/8" [1489]  
18 5/8" [473] (2)

65 7/8" [1673]  
68 15/16" [1751]  
63 3/8" [1610]  
62 5/8" [1591]  
20 5/8" [524] (2)

73 7/8" [1876]  
76 15/16" [1954]  
71 3/8" [1813]  
70 5/8" [1794]  
24 5/8" [625] (2)

81 3/8" [2067]  
82 7/8" [2105]  
80 1/4" [2038]  
79 1/2" [2019]  
65 11/16" [1668]

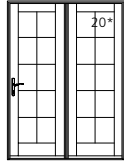

CISWR5068

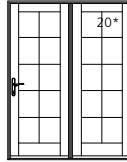

CISWR5468

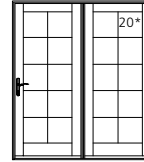

CISWR6068

97 3/8" [2473]  
98 7/8" [2511]  
96 1/4" [2445]  
95 1/2" [2426]  
81 11/16" [2075]

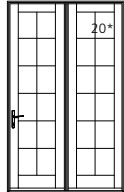

CISWR5080

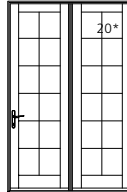

CISWR5480

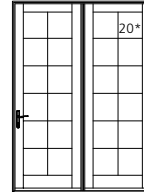

CISWR6080

109 3/8" [2778]  
110 7/8" [2816]  
108 1/4" [2750]  
107 1/2" [2731]  
93 11/16" [2380]

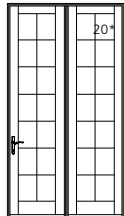

CISWR5090

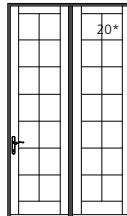

CISWR5490

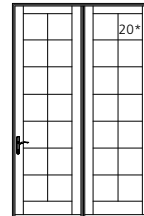

CISWR6090

**M.O. BRICKMOULD  
M.O. ADAMS/FLAT CASING  
ROUGH OPENING  
FRAME SIZE  
DAYLIGHT OPENING**

65 7/8" [1673]  
68 15/16" [1751]  
63 3/8" [1610]  
62 5/8" [1591]  
20 5/8" [524] (2)

69 7/8" [1775]  
72 15/16" [1853]  
67 3/8" [1711]  
66 5/8" [1692]  
22 5/8" [575] (2)

77 7/8" [1978]  
80 15/16" [2056]  
75 3/8" [1915]  
74 5/8" [1895]  
26 5/8" [676] (2)

89 7/8" [2283]  
92 15/16" [2361]  
87 3/8" [2219]  
86 5/8" [2200]  
32 5/8" [829] (2)

84 3/8" [2143]  
85 7/8" [2181]  
83 1/4" [2115]  
82 1/2" [2096]  
68 11/16" [1745]

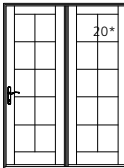

CISWT5068

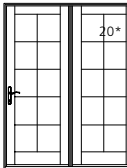

CISWT5468

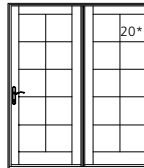

CISWT6068

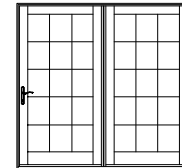

CISWT7068

88 3/8" [2245]  
89 7/8" [2283]  
87 1/4" [2216]  
86 1/2" [2197]  
72 11/16" [1846]

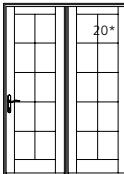

CISWT5070

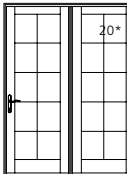

CISWT5470

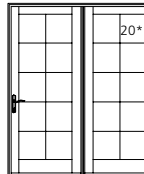

CISWT6070

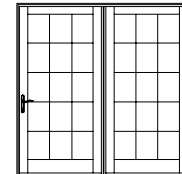

CISWT7070

100 3/8" [2550]  
101 7/8" [2588]  
99 1/4" [2521]  
98 1/2" [2502]  
84 11/16" [2151]

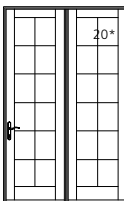

CISWT5080

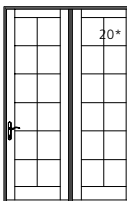

CISWT5480

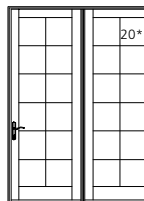

CISWT6080

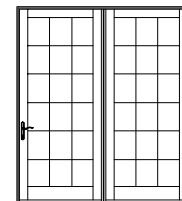

CISWT7080

112 3/8" [2854]  
113 7/8" [2892]  
111 1/4" [2826]  
110 1/2" [2807]  
96 11/16" [2456]

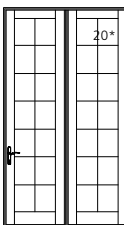

CISWT5090

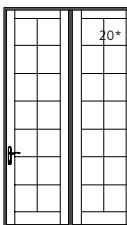

CISWT5490

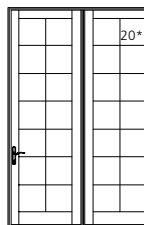

CISWT6090

**ELEVATION SYMBOL LEGEND:**

**M.O.** = MASONRY OPENING  
VALUES IN [ ] ARE IN MILLIMETER CONVERSIONS  
VALUES IN ( ) ARE NUMBER OF DAYLIGHT OPENINGS PER UNIT  
### NUMBER INDICATES DESIGN PRESSURE (DP) RATING WITH STANDARD GLAZING. OPERATING UNITS UTILIZE MULTI-POINT LOCKING HARDWARE FOR DP RATINGS.

Note: Elevations shown DO NOT have exterior trim. Subtract 1/2" (12.7) from M.O. (Masonry Opening) for Unit Size. For other Trim Options refer to the Unit Sizing, Rough Opening & Masonry Openings page.

SCALE: 1/8" = 1'

### 3-PANEL UNITS

**M.O. BRICKMOULD**  
**M.O. ADAMS/FLAT CASING**  
**ROUGH OPENING**  
**FRAME SIZE**  
**DAYLIGHT OPENING**

91 1/16" [2313]  
94 1/8" [2391]  
88 9/16" [2250]  
87 13/16" [2230]  
18 5/8" [473] (3)

97 1/16" [2465]  
100 1/8" [2543]  
94 9/16" [2402]  
93 13/16" [2383]  
20 5/8" [524] (3)

109 1/16" [2770]  
112 1/8" [2848]  
106 9/16" [2707]  
105 13/16" [2688]  
24 5/8" [625] (3)

81 3/8" [2067]  
82 7/8" [2105]  
80 1/4" [2038]  
79 1/2" [2019]  
65 11/16" [1668]

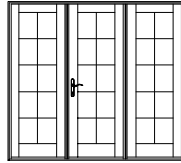

CISWR7668

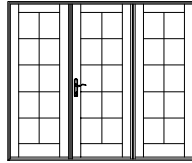

CISWR8068

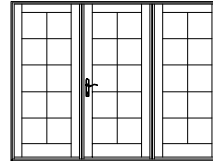

CISWR9068

97 3/8" [2473]  
98 7/8" [2511]  
96 1/4" [2445]  
95 1/2" [2426]  
81 11/16 [2075]

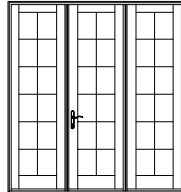

CISWR7680

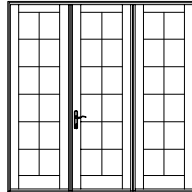

CISWR8080

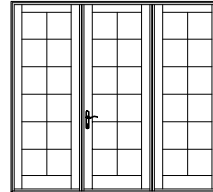

CISWR9080

109 3/8" [2778]  
110 7/8" [2816]  
108 1/4" [2750]  
107 1/2" [2731]  
93 11/16" [2380]

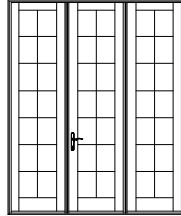

CISWR7690

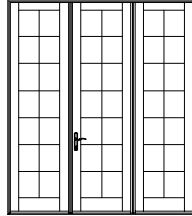

CISWR8090

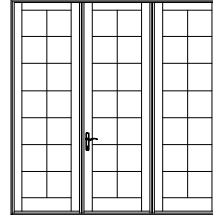

CISWR9090

**M.O. BRICKMOULD**  
**M.O. ADAMS/FLAT CASING**  
**ROUGH OPENING**  
**FRAME SIZE**  
**DAYLIGHT OPENING**

97 1/16" [2465]  
100 1/8" [2543]  
94 9/16" [2401]  
93 13/16" [2383]  
20 5/8" [524] (3)

103 1/16" [2618]  
106 1/8" [2696]  
100 9/16" [2554]  
99 13/16" [2535]  
22 5/8" [575] (3)

115 1/16" [2923]  
118 1/8" [3000]  
112 9/16" [2860]  
111 13/16" [2840]  
26 5/8" [676] (3)

84 3/8" [2143]  
85 7/8" [2181]  
83 1/4" [2115]  
82 1/2" [2096]  
68 11/16" [1745]

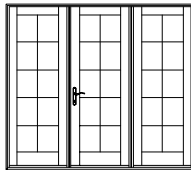

CISWT7668

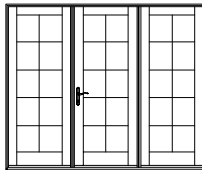

CISWT8068

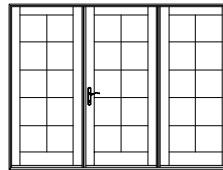

CISWT9068

88 3/8" [2245]  
89 7/8" [2283]  
87 1/4" [2216]  
86 1/2" [2197]  
72 11/16" [1846]

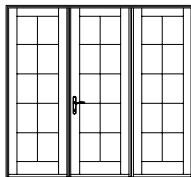

CISWT7670

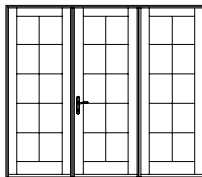

CISWT8070

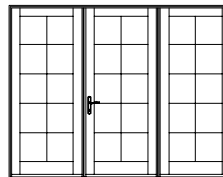

CISWT9070

100 3/8" [2550]  
101 7/8" [2588]  
99 1/4" [2521]  
98 1/2" [2502]  
84 11/16 [2151]

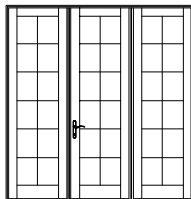

CISWT7680

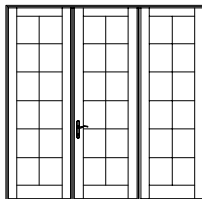

CISWT8080

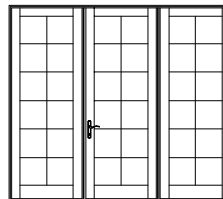

CISWT9080

112 3/8" [2854]  
113 7/8" [2892]  
111 1/4" [2826]  
110 1/2" [2807]  
96 11/16" [2455]

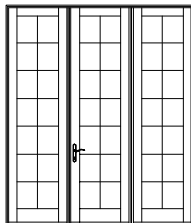

CISWT7690

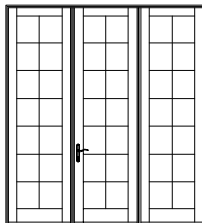

CISWT8090

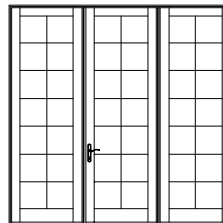

CISWT9090

**ELEVATION SYMBOL LEGEND:**  
M.O. = MASONRY OPENING  
VALUES IN [ ] ARE IN MILLIMETER CONVERSIONS  
VALUES IN ( ) ARE NUMBER OF DAYLIGHT OPENINGS PER UNIT

Note: Elevations shown DO NOT have exterior trim. Subtract 1/2" (12.7) from M.O. (Masonry Opening) for Unit Size. For other Trim Options refer to the Unit Sizing, Rough Opening & Masonry Openings page.

SCALE: 1/8" = 1'

### 2-PANEL FRENCH UNITS

**M.O. BRICKMOULD**  
**M.O. ADAMS/FLAT CASING**  
**ROUGH OPENING**  
**FRAME SIZE**  
**DAYLIGHT OPENING**

49 7/8" [1267]  
52 15/16" [1345]  
47 3/8" [1203]  
46 5/8" [1184]  
12 5/8" [321] (2)

61 7/8" [1572]  
64 15/16" [1649]  
59 3/8" [1508]  
58 5/8" [1489]  
18 5/8" [473] (2)

65 7/8" [1673]  
68 15/16" [1751]  
63 3/8" [1610]  
62 5/8" [1591]  
20 5/8" [524] (2)

73 7/8" [1876]  
76 15/16" [1954]  
71 3/8" [1813]  
70 5/8" [1794]  
24 5/8" [625] (2)

81 3/8" [2067]  
82 7/8" [2105]  
80 1/4" [2038]  
79 1/2" [2019]  
65 11/16" [1668]

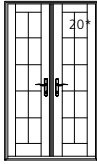

CIFRR4068

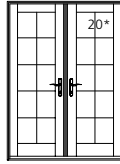

CIFRR5068

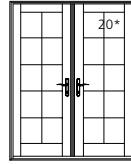

CIFRR5468

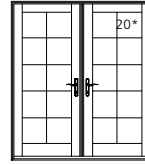

CIFRR6068

97 3/8" [2473]  
98 7/8" [2511]  
96 1/4" [2445]  
95 1/2" [2426]  
81 11/16" [2075]

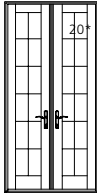

CIFRR4080

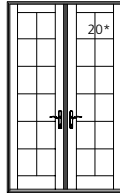

CIFRR5080

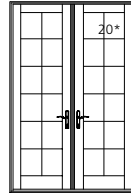

CIFRR5480

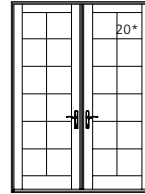

CIFRR6080

109 3/8" [2778]  
110 7/8" [2816]  
108 1/4" [2750]  
107 1/2" [2731]  
93 11/16" [2380]

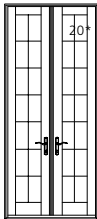

CIFRR4090

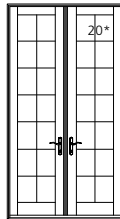

CIFRR5090

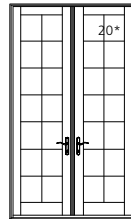

CIFRR5490

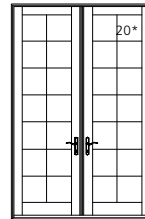

CIFRR6090

**M.O. BRICKMOULD**  
**M.O. ADAMS/FLAT CASING**  
**ROUGH OPENING**  
**FRAME SIZE**  
**DAYLIGHT OPENING**

53 7/8" [1368]  
56 15/16" [1446]  
51 3/8" [1305]  
50 5/8" [1286]  
14 5/8" [371] (2)

65 7/8" [1673]  
68 15/16" [1751]  
63 3/8" [1610]  
62 5/8" [1591]  
20 5/8" [524] (2)

69 7/8" [1775]  
72 15/16" [1853]  
67 3/8" [1711]  
66 5/8" [1692]  
22 5/8" [575] (2)

77 7/8" [1978]  
80 15/16" [2056]  
75 3/8" [1915]  
74 5/8" [1895]  
26 5/8" [676] (2)

89 7/8" [2283]  
92 15/16" [2361]  
87 3/8" [2219]  
86 5/8" [2200]  
32 5/8" [829] (2)

84 3/8" [2143]  
85 7/8" [2181]  
83 1/4" [2115]  
82 1/2" [2096]  
68 11/16" [1745]

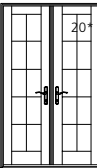

CIFRT4068

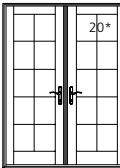

CIFRT5068

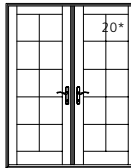

CIFRT5468

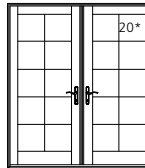

CIFRT6068

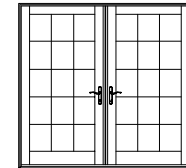

CIFRT7068

88 3/8" [2245]  
89 7/8" [2283]  
87 1/4" [2216]  
86 1/2" [2197]  
72 11/16 [1846]

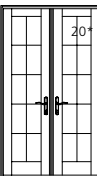

CIFRT4070

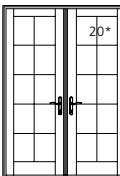

CIFRT5070

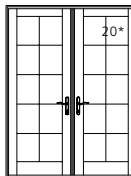

CIFRT5470

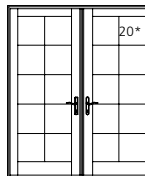

CIFRT6070

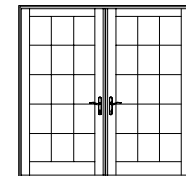

CIFRT7070

100 3/8" [2560]  
101 7/8" [2598]  
99 1/4" [2531]  
98 1/2" [2502]  
84 11/16" [2151]

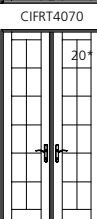

CIFRT4080

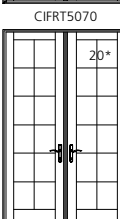

CIFRT5080

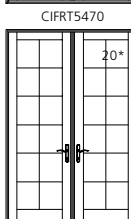

CIFRT5480

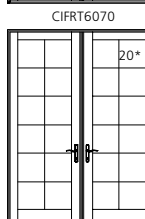

CIFRT6080

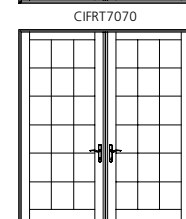

CIFRT7080

112 3/8" [2854]  
113 7/8" [2892]  
111 1/4" [2826]  
110 1/2" [2807]  
96 11/16" [2456]

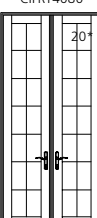

CIFRT4090

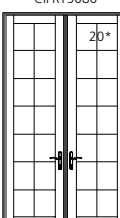

CIFRT5090

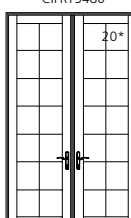

CIFRT5490

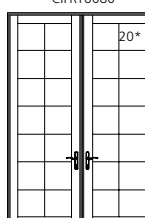

CIFRT6090

**ELEVATION SYMBOL LEGEND:**  
M.O. = MASONRY OPENING  
VALUES IN [ ] ARE IN MILLIMETER CONVERSIONS  
VALUES IN ( ) ARE NUMBER OF DAYLIGHT OPENINGS PER UNIT  
##\* NUMBER INDICATES DESIGN PRESSURE (DP) RATING WITH STANDARD GLAZING. OPERATING UNITS UTILIZE MULTI-POINT LOCKING HARDWARE FOR DP RATINGS.

Note: Elevations shown DO NOT have exterior trim. Subtract 1/2" (12.7) from M.O. (Masonry Opening) for Unit Size. For other Trim Options refer to the Unit Sizing, Rough Opening & Masonry Openings page.

SCALE: 1/8" = 1'

### 4-PANEL FRENCH UNITS

**M.O. BRICKMOULD**  
**M.O. ADAMS/FLAT CASING**  
**ROUGH OPENING**  
**FRAME SIZE**  
**DAYLIGHT OPENING**

96 1/4" [2445]  
99 5/16" [2523]  
93 3/4" [2381]  
93" [2362]  
12 5/8" [321] (4)

120 1/4" [3054]  
123 5/16" [3132]  
117 3/4" [2991]  
117" [2972]  
18 5/8" [473] (4)

144 1/4" [3664]  
147 5/16" [3742]  
141 3/4" [3600]  
141" [3581]  
24 5/8" [625] (4)

81 3/8" [2067]  
82 7/8" [2105]  
80 1/4" [2038]  
79 1/2" [2019]  
65 1 1/16" [1668]

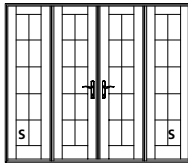

CIFRR8068

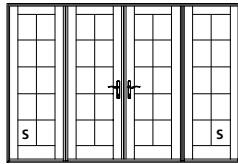

CIFRR10068

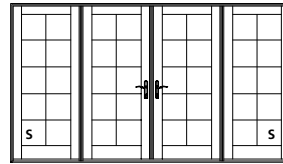

CIFRR12068

97 3/8" [2473]  
98 7/8" [2511]  
96 1/4" [2445]  
95 1/2" [2426]  
81 1 1/16" [2075]

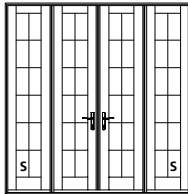

CIFRR8080

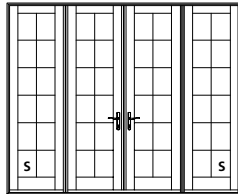

CIFRR10080

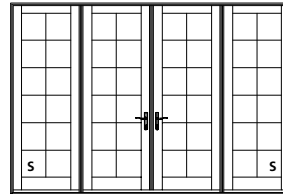

CIFRR12080

109 3/8" [2778]  
110 7/8" [2816]  
108 1/4" [2750]  
107 1/2" [2731]  
93 1 1/16" [2380]

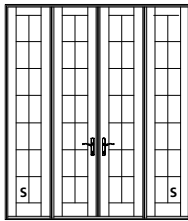

CIFRR8090

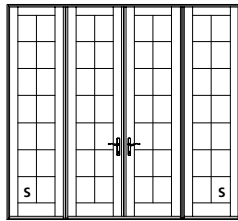

CIFRR10090

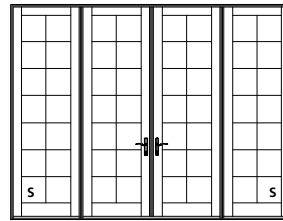

CIFRR12090

**M.O. BRICKMOULD**  
**M.O. ADAMS/FLAT CASING**  
**ROUGH OPENING**  
**FRAME SIZE**  
**DAYLIGHT OPENING**

104 1/4" [2648]  
107 5/16" [2726]  
101 3/4" [2584]  
101" [2565]  
14 5/8" [371] (4)

128 1/4" [3258]  
131 5/16" [3335]  
125 3/4" [3194]  
125" [3175]  
20 5/8" [524] (4)

152 1/4" [3867]  
155 5/16" [3945]  
149 3/4" [3804]  
149" [3785]  
26 5/8" [676] (4)

84 3/8" [2143]  
85 7/8" [2181]  
83 1/4" [2115]  
82 1/2" [2096]  
68 1 1/16" [1745]

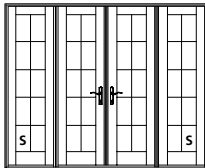

CIFRT8068

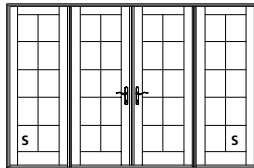

CIFRT10068

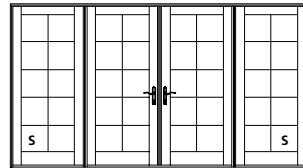

CIFRT12068

88 3/8" [2245]  
89 7/8" [2283]  
87 1/4" [2216]  
86 1/2" [2197]  
72 1 1/16" [1846]

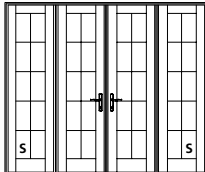

CIFRT8070

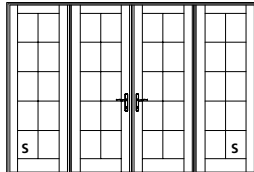

CIFRT10070

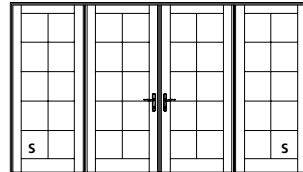

CIFRT12070

100 3/8" [2550]  
101 7/8" [2588]  
99 1/4" [2521]  
98 1/2" [2502]  
84 1 1/16" [2151]

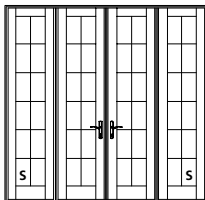

CIFRT8080

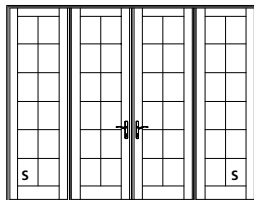

CIFRT10080

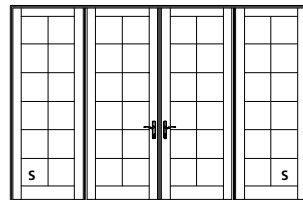

CIFRT12080

112 3/8" [2854]  
113 7/8" [2892]  
111 1/4" [2826]  
110 1/2" [2807]  
96 1 1/16" [2456]

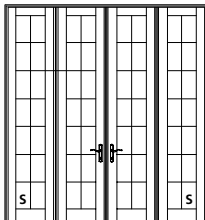

CIFRT8090

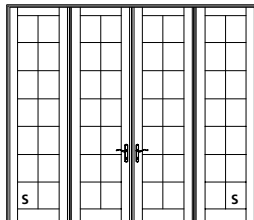

CIFRT10090

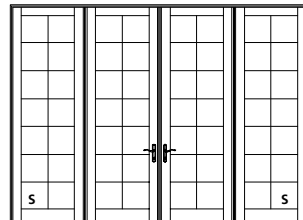

CIFRT12090

Note: Elevations shown DO NOT have exterior trim. Subtract 1/2" (12.7) from M.O. (Masonry Opening) for Unit Size. For other Trim Options refer to the Unit Sizing, Rough Opening & Masonry Openings page.

**ELEVATION SYMBOL LEGEND:**  
M.O. = MASONRY OPENING  
VALUES IN [ ] ARE IN MILLIMETER CONVERSIONS  
VALUES IN ( ) ARE NUMBER OF DAYLIGHT OPENINGS PER UNIT  
S PANEL IS AVAILABLE AS STATIONARY ONLY.

SCALE: 1/8" = 1'

### SINGLE DOOR WITH SINGLE SIDELIGHT

M.O. BRICKMOULD M.O. ADAMS/FLAT CASING ROUGH OPENING FRAME SIZE DAYLIGHT OPENING	54" [1372] 57 1/16" [1449] 51 1/2" [1308] 50 3/4" [1289] 26 5/8" [676] - 7 1/2" [190]	56" [1422] 59 1/16" [1500] 53 1/2" [1359] 52 3/4" [1340] 26 5/8" [676] - 9 1/2" [241]	58" [1473] 61 1/16" [1551] 55 1/2" [1410] 54 3/4" [1391] 26 5/8" [676] - 11 1/2" [292]
84 3/8" [2143] 85 7/8" [2181] 83 1/4" [2114] 82 1/2" [2096] 68 11/16" [1745]			
	CISWT3068B10	CISWT3068B12	CISWT3068B14
88 3/8" [2245] 89 7/8" [2283] 87 1/4" [2216] 86 1/2" [2197] 72 11/16" [1846]			
	CISWT3070B10	CISWT3070B12	CISWT3070B14
100 3/8" [2550] 101 7/8" [2588] 99 1/4" [2521] 98 1/2" [2502] 84 11/16" [2151]			
	CISWT3080B10	CISWT3080B12	CISWT3080B14
112 3/8" [2854] 113 7/8" [2892] 111 1/4" [2826] 110 1/2" [2807] 96 11/16" [2456]			
	CISWT3090B10	CISWT3090B12	CISWT3090B14
M.O. BRICKMOULD M.O. ADAMS/FLAT CASING ROUGH OPENING FRAME SIZE DAYLIGHT OPENING	60" [1524] 63 1/16" [1602] 57 1/2" [1460] 56 3/4" [1441] 32 5/8" [829] - 7 1/2" [190]	62" [1575] 65 1/16" [1653] 59 1/2" [1511] 58 3/4" [1492] 32 5/8" [829] - 9 1/2" [241]	64" [1626] 67 1/16" [1703] 61 1/2" [1562] 60 3/4" [1543] 32 5/8" [829] - 11 1/2" [292]
84 3/8" [2143] 85 7/8" [2181] 83 1/4" [2115] 82 1/2" [2096] 68 11/16" [1745]			
	CISWT3668B10	CISWT3668B12	CISWT3668B14
88 3/8" [2245] 89 7/8" [2283] 87 1/4" [2216] 86 1/2" [2197] 72 11/16" [1846]			
	CISWT3670B10	CISWT3670B12	CISWT3670B14
100 3/8" [2550] 101 7/8" [2588] 99 1/4" [2521] 98 1/2" [2502] 84 11/16" [2151]			
	CISWT3680B10	CISWT3680B12	CISWT3680B14

**ELEVATION SYMBOL LEGEND:**  
**M.O.** = MASONRY OPENING  
 VALUES IN [ ] ARE IN MILLIMETER CONVERSIONS  
 VALUES IN ( ) ARE NUMBER OF DAYLIGHT OPENINGS PER UNIT  
**S** PANEL IS AVAILABLE AS STATIONARY ONLY.

Note: Elevations shown DO NOT have exterior trim. Subtract 1/2" (12.7) from M.O. (Masonry Opening) for Unit Size. For other Trim Options refer to the Unit Sizing, Rough Opening & Masonry Openings page.

SCALE: 1/8" = 1'

### SINGLE DOOR WITH TWO SIDELIGHTS

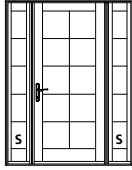
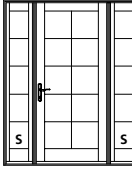
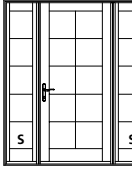
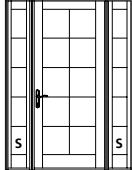
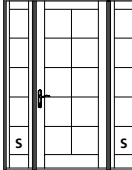
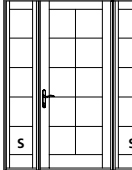
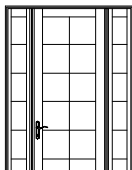
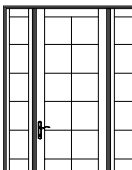
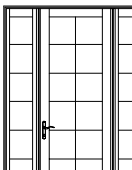
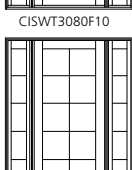
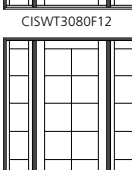
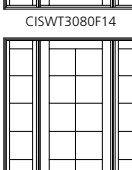
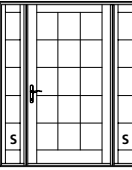
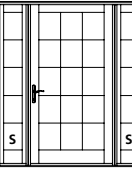
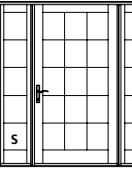
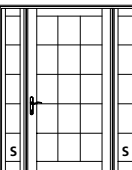
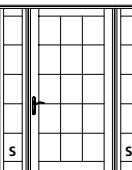
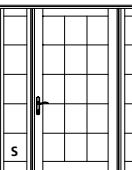
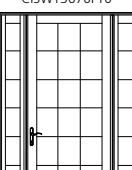
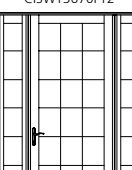
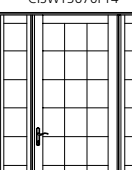
M.O. BRICKMOULD	67 5/16" [1710]	71 5/16" [1811]	75 5/16" [1913]
M.O. ADAMS/FLAT CASING	70 3/8" [1788]	74 3/8" [1889]	78 3/8" [1991]
ROUGH OPENING	64 13/16" [1646]	68 13/16" [1747]	72 13/16" [1849]
FRAME SIZE	64 1/16" [1627]	68 1/16" [1729]	72 1/16" [1830]
DAYLIGHT OPENING	26 5/8" [676] - 7 1/2" [190] (2)	26 5/8" [676] - 9 1/2" [241] (2)	26 5/8" [676] - 11 1/2" [292] (2)
84 3/8" [2143] 85 7/8" [2181] 87 1/4" [2214] 88 1/2" [2245] 89 7/8" [2283]			
	CISWT3068F10	CISWT3068F12	CISWT3068F14
88 3/8" [2245] 89 7/8" [2283] 87 1/4" [2216] 86 1/2" [2197] 72 1 1/16" [1846]			
	CISWT3070F10	CISWT3070F12	CISWT3070F14
100 3/8" [2550] 101 7/8" [2588] 99 1/4" [2521] 98 1/2" [2502] 85 3/4" [2178] 84 1 1/16" [2151]			
	CISWT3080F10	CISWT3080F12	CISWT3080F14
112 3/8" [2854] 113 7/8" [2892] 111 1/4" [2825] 110 1/2" [2807] 96 1 1/16" [2456]			
	CISWT3090F10	CISWT3090F12	CISWT3090F14
M.O. BRICKMOULD	73 5/16" [1862]	77 5/16" [1964]	81 5/16" [2065]
M.O. ADAMS/FLAT CASING	76 3/8" [1940]	80 3/8" [2042]	84 3/8" [2143]
ROUGH OPENING	70 13/16" [1798]	74 13/16" [1900]	78 13/16" [2001]
FRAME SIZE	70 1/16" [1780]	74 1/16" [1881]	78 1/16" [1983]
DAYLIGHT OPENING	32 5/8" [829] - 7 1/2" [190] (2)	32 5/8" [829] - 9 1/2" [241] (2)	32 5/8" [829] - 11 1/2" [292] (2)
84 3/8" [2143] 85 7/8" [2181] 83 1/4" [2114] 82 1/2" [2096] 68 1 1/16" [1745]			
	CISWT3668F10	CISWT3668F12	CISWT3668F14
88 3/8" [2245] 89 7/8" [2283] 87 1/4" [2216] 86 1/2" [2197]			
	CISWT3670F10	CISWT3670F12	CISWT3670F14
100 3/8" [2550] 101 7/8" [2588] 99 1/4" [2521] 98 1/2" [2502] 84 1 1/16" [2151]			
	CISWT3680F10	CISWT3680F12	CISWT3680F14

**ELEVATION SYMBOL LEGEND:**

M.O. = MASONRY OPENING  
 VALUES IN [ ] ARE IN MILLIMETER CONVERSIONS  
 VALUES IN ( ) ARE NUMBER OF DAYLIGHT OPENINGS PER UNIT  
 S PANEL IS AVAILABLE AS STATIONARY ONLY.

Note: Elevations shown DO NOT have exterior trim. Subtract 1/2" (12.7) from M.O. (Masonry Opening) for Unit Size. For other Trim Options refer to the Unit Sizing, Rough Opening & Masonry Openings page.

SCALE: 1/8" = 1'

**FRENCH DOOR WITH TWO SIDELIGHTS**  
**5-0 UNITS**

**M.O. BRICKMOULD**  
**M.O. ADAMS/FLAT CASING**  
**ROUGH OPENING**  
**FRAME SIZE**  
**DAYLIGHT OPENING**

92 1/2" [2350]  
95 9/16" [2427]  
90" [2286]  
89 1/4" [2267]  
20 5/8" [524] (2) - 7 1/2" [190] (2)

96 1/2" [2451]  
99 9/16" [2529]  
94" [2387]  
93 1/4" [2369]  
20 5/8" [524] (2) - 9 1/2" [241] (2)

100 1/2" [2553]  
103 9/16" [2630]  
98" [2489]  
97 1/4" [2470]  
20 5/8" [524] (2) - 11 1/2" [292] (2)

84 3/8" [2143]  
85 7/8" [2181]  
83 1/4" [2114]  
82 1/2" [2096]  
68 11/16" [1745]

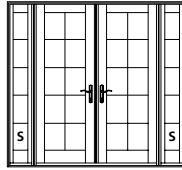

CIFRT5068Q10

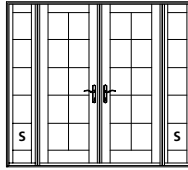

CIFRT5068Q12

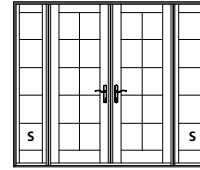

CIFRT5068Q14

88 3/8" [2245]  
89 7/8" [2283]  
87 1/4" [2216]  
86 1/2" [2197]  
72 11/16" [1846]

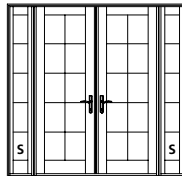

CIFRT5070Q10

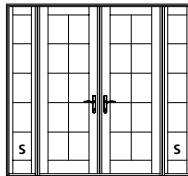

CIFRT5070Q12

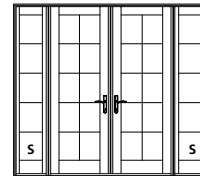

CIFRT5070Q14

100 3/8" [2550]  
101 7/8" [2588]  
99 1/4" [2521]  
98 1/2" [2502]  
84 11/16" [2151]

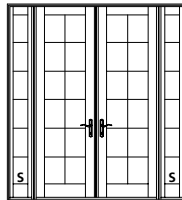

CIFRT5080Q10

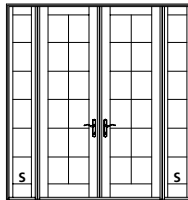

CIFRT5080Q12

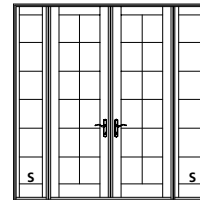

CIFRT5080Q14

112 3/8" [2854]  
113 7/8" [2892]  
111 1/4" [2825]  
110 1/2" [2807]  
96 11/16" [2456]

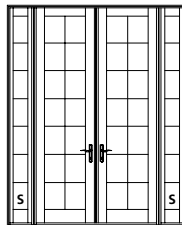

CIFRT5090Q10

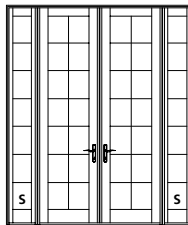

CIFRT5090Q12

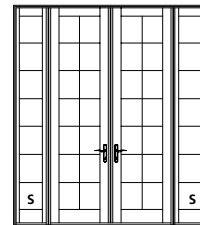

CIFRT5090Q14

**ELEVATION SYMBOL LEGEND:**

**M.O.** = MASONRY OPENING  
VALUES IN [ ] ARE IN MILLIMETER CONVERSIONS  
VALUES IN ( ) ARE NUMBER OF DAYLIGHT OPENINGS PER UNIT  
**S** PANEL IS AVAILABLE AS STATIONARY ONLY.

Note: Elevations shown DO NOT have exterior trim. Subtract 1/2" (12.7) from M.O. (Masonry Opening) for Unit Size. For other Trim Options refer to the Unit Sizing, Rough Opening & Masonry Openings page.

SCALE: 1/8" = 1'

**FRENCH DOOR WITH TWO SIDELIGHTS**  
**5-4 UNITS**

**M.O. BRICKMOLD**  
**M.O. ADAMS/FLAT CASING**  
**ROUGH OPENING**  
**FRAME SIZE**  
**DAYLIGHT OPENING**

96 1/2" [2451]  
99 9/16" [2529]  
94" [2387]  
93 1/4" [2369]  
22 5/8" [575] (2) - 7 1/2" [190] (2)

100 1/2" [2553]  
103 9/16" [2630]  
98" [2489]  
97 1/4" [2470]  
22 5/8" [575] (2) - 9 1/2" [241] (2)

104 1/2" [2654]  
107 9/16" [2732]  
102" [2600]  
101 1/4" [2572]  
22 5/8" [602] (2) - 11 1/2" [292] (2)

84 3/8" [2143]  
85 7/8" [2181]  
83 1/4" [2114]  
82 1/2" [2096]  
68 11/16" [1745]

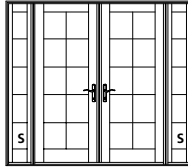

CIFRT5468Q10

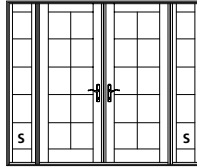

CIFRT5468Q12

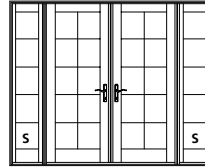

CIFRT5468Q14

88 3/8" [2245]  
89 7/8" [2283]  
87 1/4" [2216]  
86 1/2" [2197]  
72 11/16" [1846]

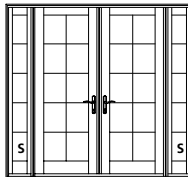

CIFRT5470Q10

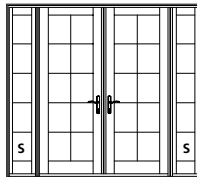

CIFRT5470Q12

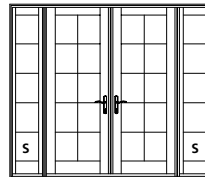

CIFRT5470Q14

100 3/8" [2550]  
101 7/8" [2588]  
99 1/4" [2521]  
98 1/2" [2502]  
84 11/16" [2151]

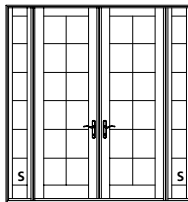

CIFRT5480Q10

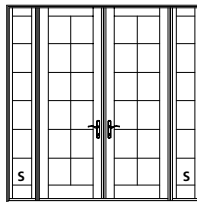

CIFRT5480Q12

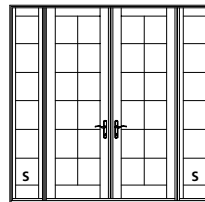

CIFRT5480Q14

112 3/8" [2854]  
113 7/8" [2892]  
111 1/4" [2825]  
110 1/2" [2807]  
96 11/16" [2456]

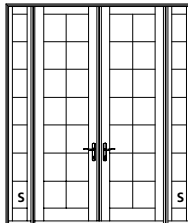

CIFRT5490Q10

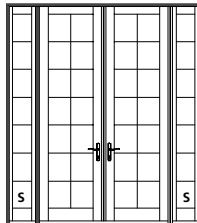

CIFRT5490Q12

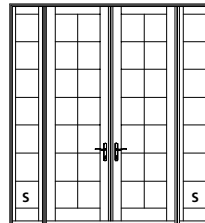

CIFRT5490Q14

**ELEVATION SYMBOL LEGEND:**

**M.O.** = MASONRY OPENING  
VALUES IN [ ] ARE IN MILLIMETER CONVERSIONS  
VALUES IN ( ) ARE NUMBER OF DAYLIGHT OPENINGS PER UNIT  
**S** PANEL IS AVAILABLE AS STATIONARY ONLY.

Note: Elevations shown DO NOT have exterior trim. Subtract 1/2" (12.7) from M.O. (Masonry Opening) for Unit Size. For other Trim Options refer to the Unit Sizing, Rough Opening & Masonry Openings page.

SCALE: 1/8" = 1'



**FRENCH DOOR WITH TWO SIDELIGHTS**  
**6-0 UNITS**

**M.O. BRICKMOULD**  
**M.O. ADAMS/FLAT CASING**  
**ROUGH OPENING**  
**FRAME SIZE**  
**DAYLIGHT OPENING**

104 1/2" [2654]  
107 9/16" [2732]  
102" [2590]  
101 1/4" [2572]  
26 5/8" [676] (2) - 7 1/2" [190] (2)

108 1/2" [2756]  
111 9/16" [2834]  
106" [2692]  
105 1/4" [2673]  
26 5/8" [676] (2) - 9 1/2" [241] (2)

112 1/2" [2858]  
115 9/16" [2935]  
110" [2794]  
109 1/4" [2775]  
26 5/8" [676] (2) - 11 1/2" [292] (2)

84 3/8" [2143]  
85 7/8" [2181]  
83 1/4" [2114]  
82 1/2" [2096]  
69 3/4" [1772]  
69 3/4" [1745]

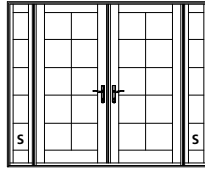

CIFRT6068Q10

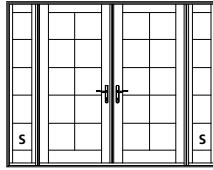

CIFRT6068Q12

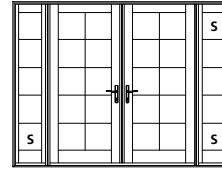

CIFRT6068Q14

88 3/8" [2245]  
89 7/8" [2283]  
87 1/4" [2216]  
86 1/2" [2197]  
75 3/4" [1872]  
72 1/16" [1846]

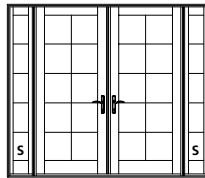

CIFRT6070Q10

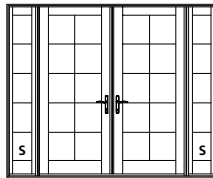

CIFRT6070Q12

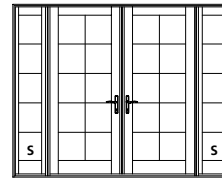

CIFRT6070Q14

100 3/8" [2550]  
101 7/8" [2588]  
99 1/4" [2521]  
98 1/2" [2502]  
85 3/4" [2178]  
84 1/16" [2151]

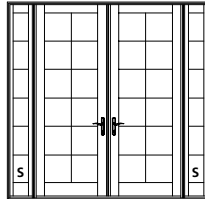

CIFRT6080Q10

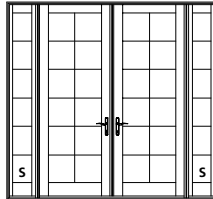

CIFRT6080Q12

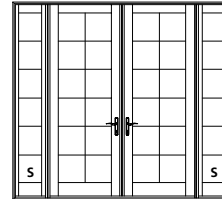

CIFRT6080Q14

112 3/8" [2854]  
113 7/8" [2892]  
111 1/4" [2825]  
110 1/2" [2807]  
97 3/4" [2483]  
96 1/16" [2456]

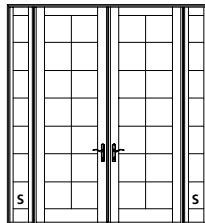

CIFRT6090Q10

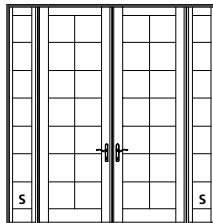

CIFRT6090Q12

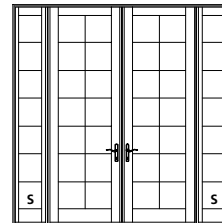

CIFRT6090Q14

**ELEVATION SYMBOL LEGEND:**

**M.O.** = MASONRY OPENING  
VALUES IN ( ) ARE IN MILLIMETER CONVERSIONS  
VALUES IN ( ) ARE NUMBER OF DAYLIGHT OPENINGS PER UNIT  
**S** PANEL IS AVAILABLE AS STATIONARY ONLY.

Note: Elevations shown DO NOT have exterior trim. Subtract 1/2" (12.7) from M.O. (Masonry Opening) for Unit Size. For other Trim Options refer to the Unit Sizing, Rough Opening & Masonry Openings page.

SCALE: 1/8" = 1'

**FRENCH DOOR WITH TWO SIDELIGHTS**  
**7-0 UNITS**

**M.O. BRICKMOULD**  
**M.O. ADAMS/FLAT CASING**  
**ROUGH OPENING**  
**FRAME SIZE**  
**DAYLIGHT OPENING**

116 1/2" [2959]  
119 9/16" [3037]  
114" [2885]  
113 1/4" [2877]  
32 5/8" [829] (2) - 7 1/2" [190] (2)

120 1/2" [3061]  
123 9/16" [3138]  
118" [2997]  
117 1/4" [2978]  
32 5/8" [829] (2) - 9 1/2" [241] (2)

124 1/2" [3162]  
127 9/16" [3240]  
122" [3098]  
121 1/4" [3080]  
32 5/8" [829] (2) - 11 1/2" [292] (2)

84 3/8" [2143]  
85 7/8" [2181]  
83 1/4" [2114]  
82 1/2" [2096]  
68 11/16" [1745]

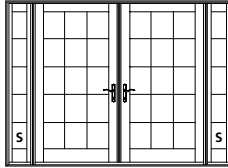

CIFRT7068Q10

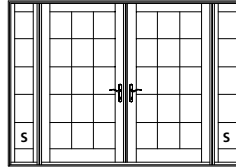

CIFRT7068Q12

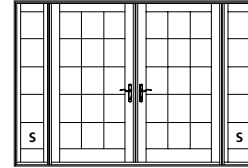

CIFRT7068Q14

88 3/8" [2245]  
89 7/8" [2283]  
87 1/4" [2216]  
86 1/2" [2197]  
72 11/16" [1846]

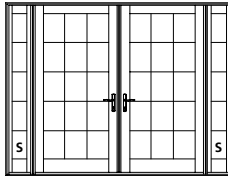

CIFRT7070Q10

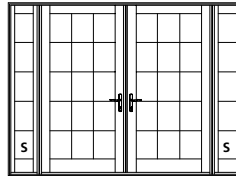

CIFRT7070Q12

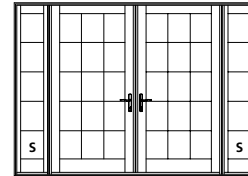

CIFRT7070Q14

100 3/8" [2550]  
101 7/8" [2588]  
99 1/4" [2521]  
98 1/2" [2502]  
84 11/16" [2151]

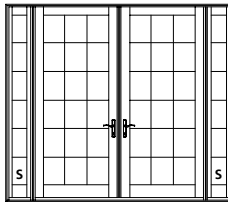

CIFRT7080Q10

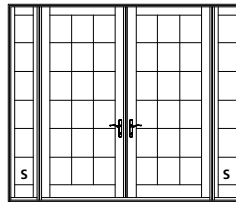

CIFRT7080Q12

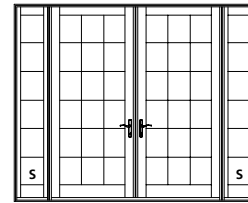

CIFRT7080Q14

**ELEVATION SYMBOL LEGEND:**

**M.O.** = MASONRY OPENING  
VALUES IN [ ] ARE IN MILLIMETER CONVERSIONS  
VALUES IN ( ) ARE NUMBER OF DAYLIGHT OPENINGS PER UNIT  
**S** PANEL IS AVAILABLE AS STATIONARY ONLY.

Note: Elevations shown DO NOT have exterior trim. Subtract 1/2" (12.7) from M.O. (Masonry Opening) for Unit Size. For other Trim Options refer to the Unit Sizing, Rough Opening & Masonry Openings page.

SCALE: 1/8" = 1'

### SINGLE SASH TRANSOMS

<b>M.O. BRICKMOULD</b>	26 11/16" [678]	32 11/16" [830]	38 11/16" [983]	49 7/8" [1267]	61 7/8" [1572]	73 7/8" [1876]
<b>M.O. ADAMS/FLAT CASING</b>	29 3/4" [756]	35 3/4" [908]	41 3/4" [1060]	52 15/16" [1345]	64 15/16" [1649]	76 15/16" [1954]
<b>ROUGH OPENING</b>	24 3/16" [614]	30 3/16" [767]	36 3/16" [919]	47 3/8" [1203]	59 3/8" [1508]	71 3/8" [1815]
<b>FRAME SIZE</b>	23 7/16" [595]	29 7/16" [748]	35 7/16" [900]	46 5/8" [1184]	58 5/8" [1489]	70 5/8" [1794]
<b>DAYLIGHT OPENING</b>	12 5/8" [321]	18 5/8" [473]	24 5/8" [625]	35 13/16" [910]	47 13/16" [1214]	59 13/16" [1519]

20 1/2" [521]  
22" [559]  
18 3/4" [476]  
18" [457]  
10 15/16" [278]



32 1/2" [826]  
34" [864]  
30 3/4" [781]  
30" [762]  
22 15/16" [583]



<b>M.O. BRICKMOULD</b>	16 13/16" [427]	18 13/16" [478]	20 13/16" [529]	28 11/16" [729]	34 11/16" [881]	36 11/16" [932]	40 11/16" [1033]	46 11/16" [1186]
<b>M.O. ADAMS/FLAT CASING</b>	19 7/8" [505]	21 7/8" [556]	23 7/8" [606]	31 3/4" [806]	37 3/4" [959]	39 3/4" [1010]	43 3/4" [1111]	49 3/4" [1264]
<b>ROUGH OPENING</b>	14 5/16" [364]	16 5/16" [414]	18 5/16" [465]	26 3/16" [665]	32 3/16" [818]	34 3/16" [868]	38 3/16" [970]	44 3/16" [1122]
<b>FRAME SIZE</b>	13 9/16" [344]	15 9/16" [395]	17 9/16" [446]	25 7/16" [646]	31 7/16" [799]	33 7/16" [849]	37 7/16" [951]	43 7/16" [1103]
<b>DAYLIGHT OPENING</b>	7 1/2" [190]	9 1/2" [241]	11 1/2" [292]	14 5/8" [371]	20 5/8" [524]	22 5/8" [575]	26 5/8" [676]	32 5/8" [829]

20 1/2" [521]  
22" [559]  
18 3/4" [476]  
18" [457]  
10 15/16" [278]



32 1/2" [826]  
34" [864]  
30 3/4" [781]  
30" [762]  
22 15/16" [583]



<b>M.O. BRICKMOULD</b>	53 7/8" [1368]	65 7/8" [1673]	69 7/8" [1775]	77 7/8" [1978]	89 7/8" [2283]
<b>M.O. ADAMS/FLAT CASING</b>	56 15/16" [1446]	68 15/16" [1751]	72 15/16" [1853]	80 15/16" [2056]	92 15/16" [2361]
<b>ROUGH OPENING</b>	51 3/8" [1305]	63 3/8" [1610]	67 3/8" [1711]	75 3/8" [1915]	87 3/8" [2219]
<b>FRAME SIZE</b>	62 5/8" [1591]	62 5/8" [1591]	66 5/8" [1692]	74 5/8" [1895]	86 5/8" [2200]
<b>DAYLIGHT OPENING</b>	39 13/16" [1011]	51 13/16" [1316]	55 13/16" [1418]	63 13/16" [1621]	75 13/16" [1926]

20 1/2" [521]  
22" [559]  
18 3/4" [476]  
18" [457]  
10 15/16" [278]

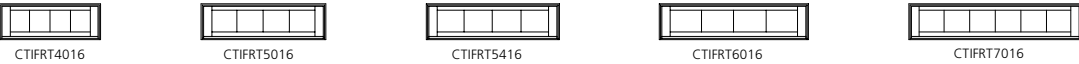

32 1/2" [826]  
34" [864]  
30 3/4" [781]  
30" [762]  
22 15/16" [583]

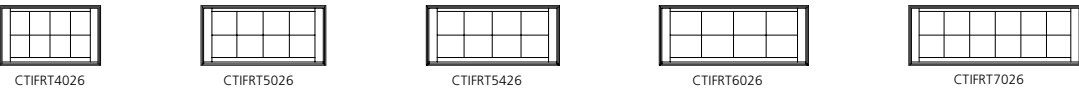

























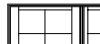

**ELEVATION SYMBOL LEGEND:**  
**M.O.** = MASONRY OPENING  
 VALUES IN [ ] ARE IN MILLIMETER CONVERSIONS  
 VALUES IN ( ) ARE NUMBER OF DAYLIGHT OPENINGS PER UNIT

Note: Vertical Masonry Opening sizes are shown for units with 4-9/16" jamb. For transom units with 6-9/16" jamb subtract 1/8" from the finished dimensions.

Note: Elevations shown DO NOT have exterior trim. Subtract 1/2" (12.7) from M.O. (Masonry Opening) for Unit Sizes. Masonry Openings above include Sill Nose, see Transom Rail & Sill Options page for Sill Nose specifications. For other Trim Options refer to the Unit Sizing, Rough Opening & Masonry Openings page.

SCALE: 1/8" = 1'

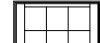
**2-SASH TRANSOMS**

<b>M.O. BRICKMOULD</b> <b>M.O. ADAMS/FLAT CASING</b> <b>ROUGH OPENING</b> <b>FRAME SIZE</b> <b>DAYLIGHT OPENING</b>	49 7/8" [1267] 52 15/16" [1345] 47 3/8" [1203] 46 5/8" [1184] 12 5/8" [321] (2)	61 7/8" [1572] 64 15/16" [1649] 59 3/8" [1508] 58 5/8" [1489] 18 5/8" [473] (2)	73 7/8" [1876] 76 15/16" [1954] 71 3/8" [1813] 70 5/8" [1794] 24 5/8" [625] (2)	53 7/8" [1368] 56 15/16" [1446] 51 3/8" [1305] 50 5/8" [1286] 14 5/8" [371] (2)	 CTISWR4016	 CTISWR5016	 CTISWR6016	 CTISWT4016
	20 1/2" [521] 22" [559] 18 3/4" [476] 18" [457] 10 15/16" [278]	 CTISWR4026	 CTISWR5026	 CTISWR6026	 CTISWT4026			
<b>M.O. BRICKMOULD</b> <b>M.O. ADAMS/FLAT CASING</b> <b>ROUGH OPENING</b> <b>FRAME SIZE</b> <b>DAYLIGHT OPENING</b>	65 7/8" [1673] 68 15/16" [1751] 63 3/8" [1610] 62 5/8" [1591] 20 5/8" [524] (2)	69 7/8" [1775] 72 15/16" [1853] 67 3/8" [1711] 66 5/8" [1692] 22 5/8" [575] (2)	77 7/8" [1978] 80 15/16" [2056] 75 3/8" [1915] 74 5/8" [1895] 26 5/8" [676] (2)	89 7/8" [2263] 92 15/16" [2361] 87 3/8" [2219] 86 5/8" [2200] 32 5/8" [829] (2)	 CTISWT5016	 CTISWT5416	 CTISWT6016	 CTISWT7016
	20 1/2" [521] 22" [559] 18 3/4" [476] 18" [457] 10 15/16" [278]	 CTISWT5026	 CTISWT5426	 CTISWT6026	 CTISWT7026			
<b>M.O. BRICKMOULD</b> <b>M.O. ADAMS/FLAT CASING</b> <b>ROUGH OPENING</b> <b>FRAME SIZE</b> <b>DAYLIGHT OPENING</b>	54" [1372] 57 1/16" [1449] 51 1/2" [1308] 50 3/4" [1289] 26 5/8" [676] - 7 1/2" [190]	56" [1422] 59 1/16" [1500] 53 1/2" [1359] 52 3/4" [1340] 26 5/8" [703] - 9 1/2" [241]	58" [1473] 61 1/16" [1551] 55 1/2" [1410] 54 3/4" [1391] 26 5/8" [676] - 11 1/2" [292]	 CTISWT3016B10	 CTISWT3016B12	 CTISWT3016B14		
	20 1/2" [521] 22" [559] 18 3/4" [476] 18" [457] 10 15/16" [278]	 CTISWT3026B10	 CTISWT3026B12	 CTISWT3026B14				
<b>M.O. BRICKMOULD</b> <b>M.O. ADAMS/FLAT CASING</b> <b>ROUGH OPENING</b> <b>FRAME SIZE</b> <b>DAYLIGHT OPENING</b>	60" [1524] 63 1/16" [1602] 57 1/2" [1461] 56 3/4" [1441] 32 5/8" [829] - 7 1/2" [190]	62" [1575] 65 1/16" [1653] 59 1/2" [1511] 58 3/4" [1492] 32 5/8" [829] - 9 1/2" [241]	64" [1626] 67 1/16" [1703] 61 1/2" [1562] 60 3/4" [1543] 32 5/8" [829] - 11 1/2" [292]	 CTISWT3616B10	 CTISWT3616B12	 CTISWT3616B14		
	20 1/2" [521] 22" [559] 18 3/4" [476] 18" [457] 10 15/16" [278]	 CTISWT3626B10	 CTISWT3626B12	 CTISWT3626B14				

**ELEVATION SYMBOL LEGEND:**  
**M.O.** = MASONRY OPENING  
 VALUES IN [ ] ARE IN MILLIMETER CONVERSIONS  
 VALUES IN ( ) ARE NUMBER OF DAYLIGHT OPENINGS PER UNIT

Note: Elevations shown DO NOT have exterior trim. Subtract 1/2" (12.7) from M.O. (Masonry Opening) for Unit Sizes. Masonry Openings above include Sill Nose, see Transom Rail & Sill Options page for Sill Nose specifications. For other Trim Options refer to the Unit Sizing, Rough Opening & Masonry Openings page.

SCALE: 1/8" = 1'

**3-SASH TRANSOMS**

**M.O. BRICKMOULD**  
**M.O. ADAMS/FLAT CASING**  
**ROUGH OPENING**  
**FRAME SIZE**  
**DAYLIGHT OPENING**

91 1/16" [2313]  
94 1/8" [2391]  
88 9/16" [2249]  
87 13/16" [2230]  
18 5/8" [473] (3)

109 1/16" [2770]  
112 1/8" [2848]  
106 9/16" [2707]  
105 13/16" [2688]  
24 5/8" [625] (3)

97 1/16" [2465]  
100 1/8" [2543]  
94 9/16" [2402]  
93 13/16" [2383]  
20 5/8" [524] (3)

20 1/2" [521]  
22" [559]  
18 3/4" [476]  
30 3/4" [781]  
30" [762]  
22 15/16" [583]



CTISWR7616

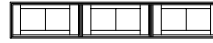

CTISWR9016

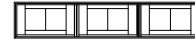

CTISWT7616

32 1/2" [826]  
34" [864]  
30 3/4" [781]  
30" [762]  
22 15/16" [583]

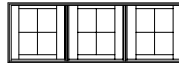

CTISWR7626

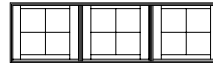

CTISWR9026

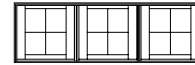

CTISWT7626

**M.O. BRICKMOULD**  
**M.O. ADAMS/FLAT CASING**  
**ROUGH OPENING**  
**FRAME SIZE**  
**DAYLIGHT OPENING**

103 1/16" [2618]  
106 1/8" [2696]  
100 9/16" [2554]  
99 13/16" [2535]  
22 5/8" [575] (3)

115 1/16" [2923]  
118 1/8" [3000]  
112 9/16" [2859]  
111 13/16" [2840]  
26 5/8" [676] (3)

20 1/2" [521]  
22" [559]  
18 3/4" [476]  
30 3/4" [781]  
30" [762]  
22 15/16" [583]

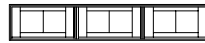

CTISWT8016

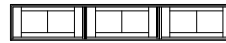

CTISWT9016

32 1/2" [826]  
34" [864]  
30 3/4" [781]  
30" [762]  
22 15/16" [583]



CTISWT8026

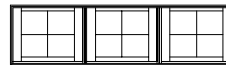

CTISWT9026

**M.O. BRICKMOULD**  
**M.O. ADAMS/FLAT CASING**  
**ROUGH OPENING**  
**FRAME SIZE**  
**DAYLIGHT OPENING**

67 5/16" [1710]  
70 3/8" [1788]  
64 13/16" [1646]  
64 1/16" [1627]  
26 5/8" [676] - 7 1/2" [190] (2)

71 1/16" [1811]  
74 3/8" [1889]  
68 13/16" [1748]  
68 1/16" [1729]  
26 5/8" [676] - 9 1/2" [241] (2)

75 1/16" [1913]  
78 3/8" [1991]  
72 13/16" [1849]  
72 1/16" [1830]  
26 5/8" [676] - 11 1/2" [292] (2)

20 1/2" [521]  
22" [559]  
18 3/4" [476]  
30 3/4" [781]  
30" [762]  
22 15/16" [583]



CTISWT3016F10



CTISWT3016F12



CTISWT3016F12

32 1/2" [826]  
34" [864]  
30 3/4" [781]  
30" [762]  
22 15/16" [583]

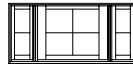

CTISWT3026F10

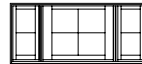

CTISWT3026F12

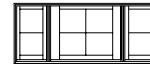

CTISWT3026F12

**M.O. BRICKMOULD**  
**M.O. ADAMS/FLAT CASING**  
**ROUGH OPENING**  
**FRAME SIZE**  
**DAYLIGHT OPENING**

73 5/16" [1862]  
76 3/8" [1940]  
70 13/16" [1799]  
70 1/16" [1780]  
32 5/8" [829] - 7 1/2" [190] (2)

77 5/16" [1964]  
80 3/8" [2042]  
74 13/16" [1900]  
74 1/16" [1881]  
32 5/8" [829] - 9 1/2" [241] (2)

81 5/16" [2065]  
84 3/8" [2143]  
78 13/16" [2002]  
78 1/16" [1983]  
32 5/8" [829] - 11 1/2" [292] (2)

20 1/2" [521]  
22" [559]  
18 3/4" [476]  
30 3/4" [781]  
30" [762]  
22 15/16" [583]



CTISWT3616F10



CTISWT3616F10

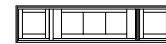

CTISWT3616F10

32 1/2" [826]  
34" [864]  
30 3/4" [781]  
30" [762]  
22 15/16" [583]

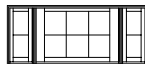

CTISWT3626F10

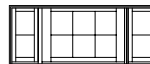

CTISWT3626F10

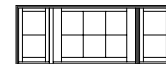

CTISWT3626F10

**ELEVATION SYMBOL LEGEND:**

M.O. = MASONRY OPENING  
VALUES IN [ ] ARE IN MILLIMETER CONVERSIONS  
VALUES IN ( ) ARE NUMBER OF DAYLIGHT OPENINGS PER UNIT

Note: Elevations shown DO NOT have exterior trim. Subtract 1/2" (12.7) from M.O. (Masonry Opening) for Unit Sizes. Masonry Openings above include Sill Nose, see Transom Rail & Sill Options page for Sill Nose specifications. For other Trim Options refer to the Unit Sizing, Rough Opening & Masonry Openings page.

SCALE: 1/8" = 1'

**4-SASH FRENCH TRANSOMS**

**M.O. BRICKMOULD**  
**M.O. ADAMS/FLAT CASING**  
**ROUGH OPENING**  
**FRAME SIZE**  
**DAYLIGHT OPENING**

96 1/4" [2445]  
99 5/16" [2523]  
93 3/4" [2381]  
93" [2362]  
12 5/8" [321] (4)

120 1/4" [3054]  
123 5/16" [3132]  
117 3/4" [2991]  
117" [2972]  
18 5/8" [473] (4)

144 1/4" [3664]  
147 5/16" [3742]  
141 3/4" [3600]  
141" [3581]  
24 5/8" [625] (4)

20 1/2" [521]  
22" [559]  
18 3/4" [476]  
18" [457]  
10 15/16" [278]



CTIFRR8016



CTIFRR10016

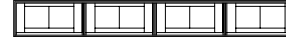

CTIFRR12016

32 1/2" [826]  
34" [864]  
30 3/4" [781]  
30" [762]  
22 15/16" [583]



CTIFRR8026

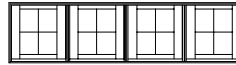

CTIFRR10026

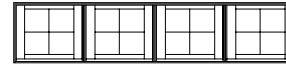

CTIFRR12026

**M.O. BRICKMOULD**  
**M.O. ADAMS/FLAT CASING**  
**ROUGH OPENING**  
**FRAME SIZE**  
**DAYLIGHT OPENING**

104 1/4" [2648]  
107 5/16" [2726]  
101 3/4" [2584]  
101" [2565]  
14 5/8" [371] (4)

128 1/4" [3258]  
131 5/16" [3335]  
125 3/4" [3194]  
125" [3175]  
20 5/8" [524] (4)

152 1/4" [3867]  
155 5/16" [3945]  
149 3/4" [3804]  
149" [3785]  
26 5/8" [676] (4)

20 1/2" [521]  
22" [559]  
18 3/4" [476]  
18" [457]  
10 15/16" [278]

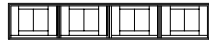

CTIFRT8016

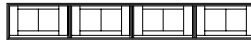

CTIFRT10016



CTIFRT12016

32 1/2" [826]  
34" [864]  
30 3/4" [781]  
30" [762]  
22 15/16" [583]



CTIFRT8026

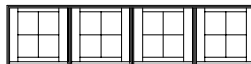

CTIFRT10026



CTIFRT12026

**ELEVATION SYMBOL LEGEND:**

















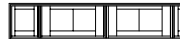



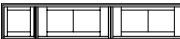

**M.O.** = MASONRY OPENING  
VALUES IN [ ] ARE IN MILLIMETER CONVERSIONS  
VALUES IN ( ) ARE NUMBER OF DAYLIGHT OPENINGS PER UNIT

Note: Elevations shown DO NOT have exterior trim. Subtract 1/2" (12.7) from M.O. (Masonry Opening) for Unit Sizes. Masonry Openings above include Sill Nose, see Transom Rail & Sill Options page for Sill Nose specifications. For other Trim Options refer to the Unit Sizing, Rough Opening & Masonry Openings page.

*Continued on next page*

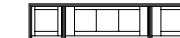
SCALE: 1/8" = 1'

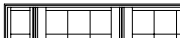
**FRENCH TRANSOMS WITH TWO SIDELIGHTS**

<b>M.O. BRICKMOULD</b> <b>M.O. ADAMS/FLAT CASING</b> <b>ROUGH OPENING</b> <b>FRAME SIZE</b> <b>DAYLIGHT OPENING</b>	92 1/2" [2350] 95 9/16" [2427] 90" [2286] 89 1/4" [2267]	96 1/2" [2451] 99 9/16" [2529] 94" [2388] 93 1/4" [2369]	100 1/2" [2553] 103 9/16" [2630] 98" [2489] 97 1/4" [2470]
	20 5/8" [524] (2) - 7 1/2" [190] (2)	20 5/8" [524] (2) - 9 1/2" [241] (2)	20 5/8" [524] (2) - 11 1/2" [292] (2)
20 1/2" [521] 22" [559] 18 3/4" [476] 18" [457] 10 15/16" [278]	 CTIFRT5016Q10	 CTIFRT5016Q12	 CTIFRT5016Q14
32 1/2" [826] 34" [864] 30 3/4" [781] 30" [762] 22 15/16" [583]	 CTIFRT5026Q10	 CTIFRT5026Q12	 CTIFRT5026Q14
<b>M.O. BRICKMOULD</b> <b>M.O. ADAMS/FLAT CASING</b> <b>ROUGH OPENING</b> <b>FRAME SIZE</b> <b>DAYLIGHT OPENING</b>	96 1/2" [2451] 99 9/16" [2529] 94" [2388] 93 1/4" [2369]	100 1/2" [2553] 103 9/16" [2630] 98" [2489] 97 1/4" [2470]	104 1/2" [2654] 107 9/16" [2732] 102" [2591] 101 1/4" [2572]
	22 5/8" [575] (2) - 7 1/2" [190] (2)	22 5/8" [575] (2) - 9 1/2" [241] (2)	22 5/8" [575] (2) - 11 1/2" [292] (2)
20 1/2" [521] 22" [559] 18 3/4" [476] 18" [457] 10 15/16" [278]	 CTIFRT5416Q10	 CTIFRT5416Q12	 CTIFRT5416Q12
32 1/2" [826] 34" [864] 30 3/4" [781] 30" [762] 22 15/16" [583]	 CTIFRT5426Q10	 CTIFRT5426Q12	 CTIFRT5426Q12
<b>M.O. BRICKMOULD</b> <b>M.O. ADAMS/FLAT CASING</b> <b>ROUGH OPENING</b> <b>FRAME SIZE</b> <b>DAYLIGHT OPENING</b>	104 1/2" [2654] 107 9/16" [2732] 102" [2591] 101 1/4" [2572]	108 1/2" [2756] 111 9/16" [2834] 106" [2692] 105 1/4" [2673]	112 1/2" [2858] 115 9/16" [2935] 110" [2794] 109 1/4" [2775]
	26 5/8" [676] (2) - 7 1/2" [190] (2)	26 5/8" [676] (2) - 9 1/2" [241] (2)	26 5/8" [676] (2) - 11 1/2" [292] (2)
20 1/2" [521] 22" [559] 18 3/4" [476] 18" [457] 10 15/16" [278]	 CTIFRT6016Q10	 CTIFRT6016Q12	 CTIFRT6016Q14
32 1/2" [826] 34" [864] 30 3/4" [781] 30" [762] 22 15/16" [583]	 CTIFRT6026Q10	 CTIFRT6026Q12	 CTIFRT6026Q14
<b>M.O. BRICKMOULD</b> <b>M.O. ADAMS/FLAT CASING</b> <b>ROUGH OPENING</b> <b>FRAME SIZE</b> <b>DAYLIGHT OPENING</b>	116 1/2" [2959] 119 9/16" [3037] 114" [2896] 113 1/4" [2877]	120 1/2" [3061] 123 9/16" [3138] 118" [2997] 117 1/4" [2978]	124 1/2" [3162] 127 9/16" [3240] 122" [3099] 121 1/4" [3080]
	32 5/8" [829] (2) - 7 1/2" [190] (2)	32 5/8" [829] (2) - 9 1/2" [241] (2)	32 5/8" [829] (2) - 11 1/2" [292] (2)
20 1/2" [521] 22" [559] 18 3/4" [476] 18" [457] 10 15/16" [278]	 CTIFRT7016Q10	 CTIFRT7016Q12	 CTIFRT7016Q14
32 1/2" [826] 34" [864] 30 3/4" [781] 30" [762] 22 15/16" [583]	 CTIFRT7026Q10	 CTIFRT7026Q12	 CTIFRT7026Q14

**ELEVATION SYMBOL LEGEND:**  
**M.O.** = MASONRY OPENING  
 VALUES IN [ ] ARE IN MILLIMETER CONVERSIONS  
 VALUES IN ( ) ARE NUMBER OF DAYLIGHT OPENINGS PER UNIT

Note: Elevations shown DO NOT have exterior trim. Subtract 1/2" (12.7) from M.O. (Masonry Opening) for Unit Sizes. Masonry Openings above include Sill Nose, see Transom Rail & Sill Options page for Sill Nose specifications. For other Trim Options refer to the Unit Sizing, Rough Opening & Masonry Openings page.

SCALE: 1/8" = 1'

### 1-PANEL SECTOR TOP DOORS

**M.O. BRICKMOULD**  
**M.O. ADAMS/FLAT CASING**  
**ROUGH OPENING**  
**FRAME SIZE**  
**DAYLIGHT OPENING**

28 11/16" [729]  
31 3/4" [806]  
26 3/16" [665]  
25 7/16" [646]  
14 5/8" [371]

34 11/16" [881]  
37 3/4" [959]  
32 3/16" [817]  
31 7/16" [799]  
20 5/8" [524]

36 11/16" [932]  
39 3/4" [1010]  
34 3/16" [868]  
33 7/16" [849]  
22 5/8" [575]

40 11/16" [1033]  
43 3/4" [1111]  
38 3/16" [970]  
37 7/16" [951]  
26 5/8" [676]

46 11/16" [1186]  
49 3/4" [1264]  
44 3/16" [1122]  
43 7/16" [1103]  
32 5/8" [829]

84 3/8" [2143]  
85 7/8" [2181]  
83 1/4" [2115]  
82 1/2" [2096]  
68 1 1/16" [1745]

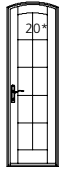

CISWTS2068

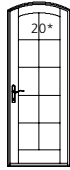

CISWTS2668

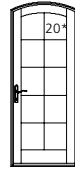

CISWTS2868

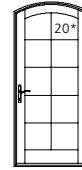

CISWTS3068

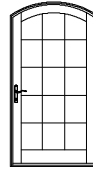

CISWTS3668

88 3/8" [2245]  
89 7/8" [2283]  
87 1/4" [2216]  
86 1/2" [2197]  
72 1 1/16" [1846]

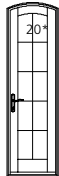

CISWTS2070

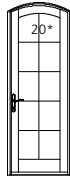

CISWTS2670

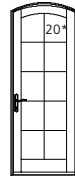

CISWTS2870

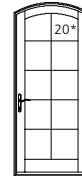

CISWTS3070

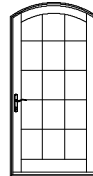

CISWTS3670

100 3/8" [2550]  
101 7/8" [2588]  
99 1/4" [2521]  
98 1/2" [2502]  
84 1 1/16" [2151]

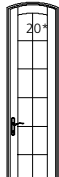

CISWTS2080

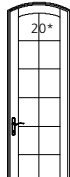

CISWTS2680

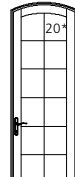

CISWTS2880

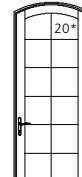

CISWTS3080

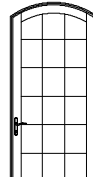

CISWTS3680

112 3/8" [2854]  
113 7/8" [2892]  
111 1/4" [2825]  
110 1/2" [2807]  
96 1 1/16" [2456]

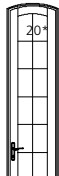

CISWTS2090

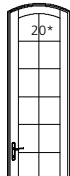

CISWTS2690

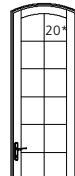

CISWTS2890

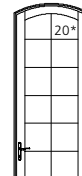

CISWTS3090

**ELEVATION SYMBOL LEGEND:**

**M.O.** = MASONRY OPENING

VALUES IN [ ] ARE IN MILLIMETER CONVERSIONS

VALUES IN ( ) ARE NUMBER OF DAYLIGHT OPENINGS PER UNIT

**##** NUMBER INDICATES DESIGN PRESSURE (DP) RATING WITH STANDARD GLAZING. OPERATING UNITS UTILIZE MULTI-POINT LOCKING HARDWARE FOR DP RATINGS.

Note: Elevations shown DO NOT have exterior trim. Subtract 1/2" (12.7) from M.O. (Masonry Opening) for Unit Size. For other Trim Options refer to the Unit Sizing, Rough Opening & Masonry Openings page.

SCALE: 1/8" = 1'



**3-PANEL SECTOR TOP DOORS**

**M.O. BRICKMOUND**  
**M.O. ADAMS/FLAT CASING**  
**ROUGH OPENING**  
**FRAME SIZE**  
**DAYLIGHT OPENING**

97 1/16" [2465]  
100 1/8" [2543]  
94 9/16" [2402]  
93 13/16" [2383]  
20 5/8" [524] (3)

103 1/16" [2618]  
106 1/8" [2696]  
100 9/16" [2554]  
99 13/16" [2535]  
22 5/8" [575] (3)

115 1/16" [2923]  
118 1/8" [3000]  
112 9/16" [2859]  
111 13/16" [2840]  
26 5/8" [676] (3)

84 3/8" [2143]  
85 7/8" [2181]  
83 1/4" [2114]  
82 1/2" [2096]  
68 11/16" [1745]

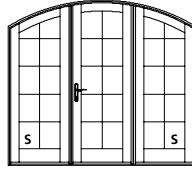

CISWTS7668

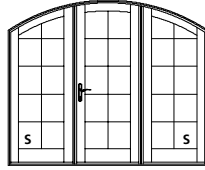

CISWTS8068

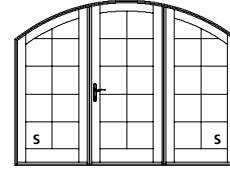

CISWTS9068

88 3/8" [2245]  
89 7/8" [2283]  
87 1/4" [2216]  
86 1/2" [2197]  
72 11/16" [1846]

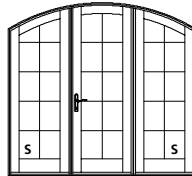

CISWTS7670

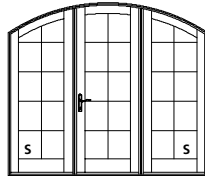

CISWTS8070

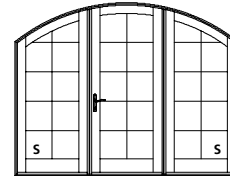

CISWTS9070

100 3/8" [2550]  
101 7/8" [2588]  
99 1/4" [2521]  
96 1/2" [2502]  
84 11/16" [2151]

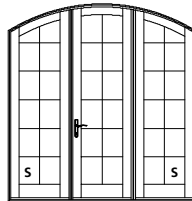

CISWTS7680

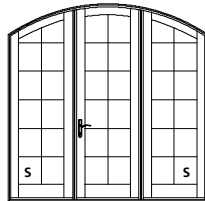

CISWTS8080

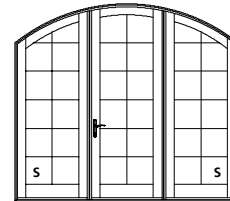

CISWTS9080

112 3/8" [2854]  
113 7/8" [2892]  
111 1/4" [2825]  
110 1/2" [2807]  
96 11/16" [2456]

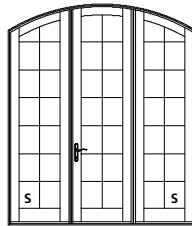

CISWTS7690

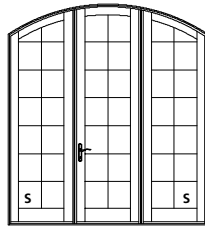

CISWTS8090

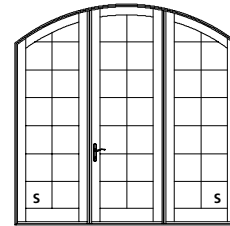

CISWTS9090

**ELEVATION SYMBOL LEGEND:**

**M.O.** = MASONRY OPENING  
VALUES IN [ ] ARE IN MILLIMETER CONVERSIONS  
VALUES IN ( ) ARE NUMBER OF DAYLIGHT OPENINGS PER UNIT  
**S** PANEL IS AVAILABLE AS STATIONARY ONLY.

Note: Elevations shown DO NOT have exterior trim. Subtract 1/2" (12.7) from M.O. (Masonry Opening) for Unit Size. For other Trim Options refer to the Unit Sizing, Rough Opening & Masonry Openings page.

SCALE: 1/8" = 1'

### 2-PANEL FRENCH SECTOR TOP DOORS

**M.O. BRICKMOULD**  
**M.O. ADAMS/FLAT CASING**  
**ROUGH OPENING**  
**FRAME SIZE**  
**DAYLIGHT OPENING**

53 7/8" [1368]  
56 15/16" [1446]  
51 3/8" [1305]  
50 5/8" [1286]  
14 5/8" [371] (2)

65 7/8" [1673]  
68 15/16" [1751]  
63 3/8" [1610]  
62 5/8" [1591]  
20 5/8" [524] (2)

69 7/8" [1775]  
72 15/16" [1853]  
67 3/8" [1711]  
66 5/8" [1692]  
22 5/8" [575] (2)

77 7/8" [1978]  
80 15/16" [2056]  
75 3/8" [1914]  
74 5/8" [1895]  
26 5/8" [676] (2)

89 7/8" [2283]  
92 15/16" [2361]  
87 3/8" [2219]  
86 5/8" [2200]  
32 5/8" [829] (2)

84 3/8" [2143]  
85 7/8" [2181]  
83 1/4" [2114]  
82 1/2" [2096]  
68 11/16" [1745]

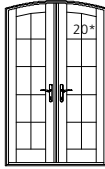

CIFRTS4068

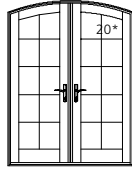

CIFRTS5068

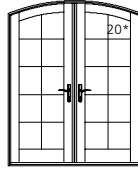

CIFRTS5468

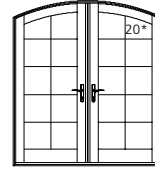

CIFRTS6068

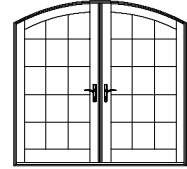

CIFRTS7068

88 3/8" [2245]  
89 7/8" [2283]  
87 1/4" [2216]  
86 1/2" [2197]  
72 11/16" [1846]

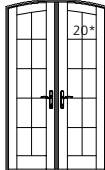

CIFRTS4070

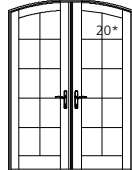

CIFRTS5070

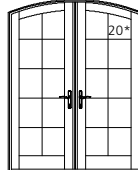

CIFRTS5470

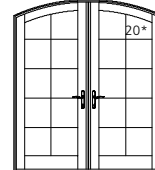

CIFRTS6070

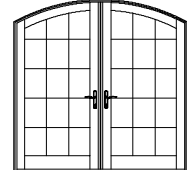

CIFRTS7070

100 3/8" [2550]  
101 7/8" [2588]  
99 1/4" [2521]  
98 1/2" [2502]  
84 11/16" [2151]

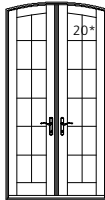

CIFRTS4080

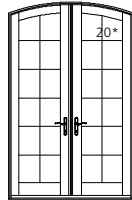

CIFRTS5080

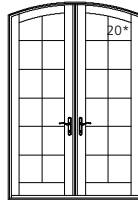

CIFRTS5480

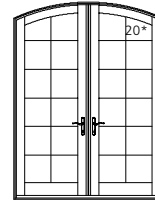

CIFRTS6080

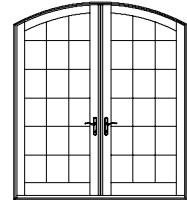

CIFRTS7080

100 3/8" [2550]  
101 7/8" [2588]  
99 1/4" [2521]  
98 1/2" [2502]  
84 11/16" [2151]

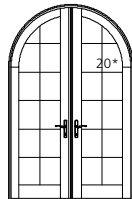

CIFRTH5080

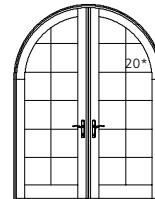

CIFRTH6080

112 3/8" [2854]  
113 7/8" [2892]  
111 1/4" [2825]  
110 1/2" [2807]  
96 11/16" [2456]

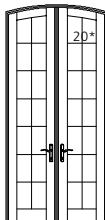

CIFRTS4090

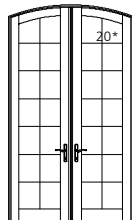

CIFRTS5090

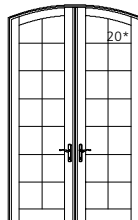

CIFRTS5490

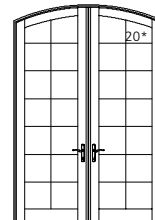

CIFRTS6090

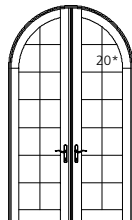

CIFRTH5090

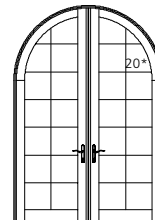

CIFRTH6090

**ELEVATION SYMBOL LEGEND:**

**M.O.** = MASONRY OPENING  
VALUES IN [ ] ARE IN MILLIMETER CONVERSIONS  
VALUES IN ( ) ARE NUMBER OF DAYLIGHT OPENINGS PER UNIT  
### NUMBER INDICATES DESIGN PRESSURE (DP) RATING  
WITH STANDARD GLAZING. OPERATING UNITS UTILIZE  
MULTI-POINT LOCKING HARDWARE FOR DP RATINGS.

Note: Elevations shown DO NOT have exterior trim. Subtract 1/2" (12.7) from M.O. (Masonry Opening) for Unit Size. For other Trim Options refer to the Unit Sizing, Rough Opening & Masonry Openings page.

SCALE: 1/8" = 1'

**4-PANEL FRENCH SECTOR TOP DOORS**

**M.O. BRICKMOUND**  
**M.O. ADAMS/FLAT CASING**  
**ROUGH OPENING**  
**FRAME SIZE**  
**DAYLIGHT OPENING**

96 1/4" [2445]  
99 5/16" [2523]  
101 3/4" [2584]  
101" [2564]  
12 5/8" [321] (4)

120 1/4" [3054]  
123 5/16" [3132]  
125 3/4" [3194]  
125" [3175]  
18 5/8" [473] (4)

84 3/8" [2143]  
85 7/8" [2181]  
83 1/4" [2115]  
82 1/2" [2096]  
68 11/16" [1745]

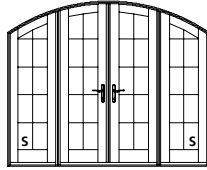

CIFRTS8068

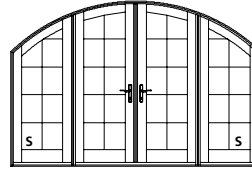

CIFRTS10068

88 3/8" [2245]  
89 7/8" [2283]  
87 1/4" [2216]  
86 1/2" [2197]  
72 11/16" [1846]

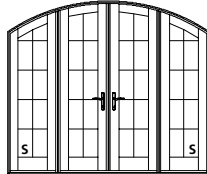

CIFRTS8070

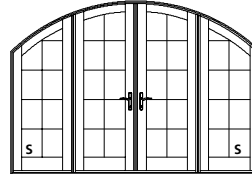

CIFRTS10070

100 3/8" [2550]  
101 7/8" [2588]  
99 1/4" [2521]  
98 1/2" [2502]  
84 11/16" [2151]

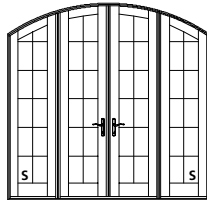

CIFRTS8080

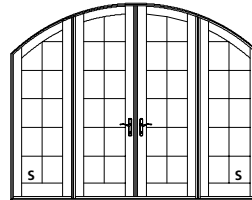

CIFRTS10080

112 3/8" [2854]  
113 7/8" [2892]  
111 1/4" [2826]  
110 1/2" [2807]  
96 11/16" [2456]

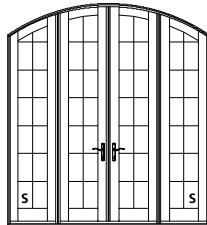

CIFRTS8090

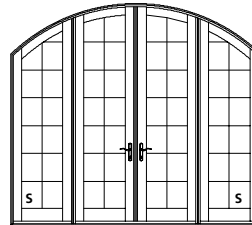

CIFRTS10090

**ELEVATION SYMBOL LEGEND:**

**M.O.** = MASONRY OPENING  
VALUES IN [ ] ARE IN MILLIMETER CONVERSIONS  
VALUES IN ( ) ARE NUMBER OF DAYLIGHT OPENINGS PER UNIT  
**S** PANEL IS AVAILABLE AS STATIONARY ONLY.

Note: Elevations shown DO NOT have exterior trim. Subtract 1/2" (12.7) from M.O. (Masonry Opening) for Unit Size. For other Trim Options refer to the Unit Sizing, Rough Opening & Masonry Openings page.

SCALE: 1/8" = 1'

**FRENCH SECTOR TOP DOOR WITH TWO SIDELIGHTS**  
**5-0 UNITS**

**M.O. BRICKMOULD**  
**M.O. ADAMS/FLAT CASING**  
**ROUGH OPENING**  
**FRAME SIZE**  
**DAYLIGHT OPENING**

92 1/2" [2350]  
95 9/16" [2427]  
90" [2286]  
89 1/4" [2267]  
20 5/8" [524] (2) - 7 1/2" [190] (2)

96 1/2" [2451]  
99 9/16" [2529]  
94" [2387]  
93 1/4" [2369]  
20 5/8" [524] (2) - 9 1/2" [241] (2)

100 1/2" [2553]  
103 9/16" [2630]  
98" [2489]  
97 1/4" [2470]  
20 5/8" [524] (2) - 11 1/2" [292] (2)

84 3/8" [2143]  
85 7/8" [2181]  
83 1/4" [2114]  
82 1/2" [2096]  
68 11/16" [1745]

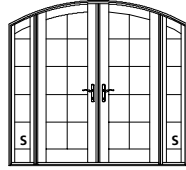

CIFRTS5068Q10

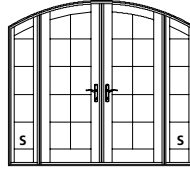

CIFRTS5068Q12

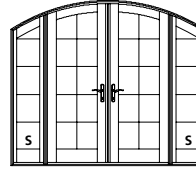

CIFRTS5068Q14

88 3/8" [2245]  
89 7/8" [2283]  
87 1/4" [2216]  
86 1/2" [2197]  
72 11/16" [1846]

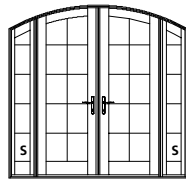

CIFRTS5070Q10

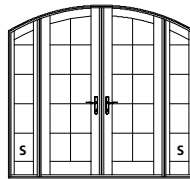

CIFRTS5070Q12

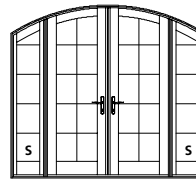

CIFRTS5070Q14

100 3/8" [2550]  
101 7/8" [2588]  
99 1/4" [2521]  
98 1/2" [2502]  
84 11/16" [2151]

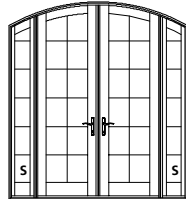

CIFRTS5080Q10

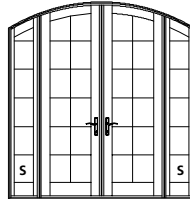

CIFRTS5080Q12

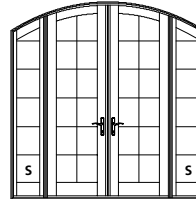

CIFRTS5080Q14

112 3/8" [2854]  
113 7/8" [2892]  
111 1/4" [2825]  
110 1/2" [2807]  
96 11/16" [2456]

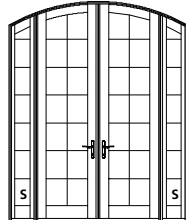

CIFRTS5090Q10

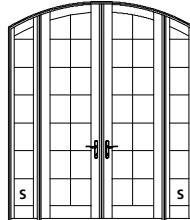

CIFRTS5090Q12

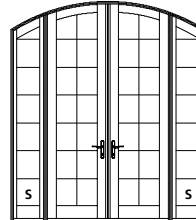

CIFRTS5090Q14

**ELEVATION SYMBOL LEGEND:**

**M.O.** = MASONRY OPENING  
VALUES IN [ ] ARE IN MILLIMETER CONVERSIONS  
VALUES IN ( ) ARE NUMBER OF DAYLIGHT OPENINGS PER UNIT  
**S** PANEL IS AVAILABLE AS STATIONARY ONLY.

Note: Elevations shown DO NOT have exterior trim. Subtract 1/2" (12.7) from M.O. (Masonry Opening) for Unit Size. For other Trim Options refer to the Unit Sizing, Rough Opening & Masonry Openings page.

SCALE: 1/8" = 1'

**FRENCH SECTOR TOP DOOR WITH TWO SIDELIGHTS**  
**5-4 UNITS**

<b>M.O. BRICKMOULD</b>	96 1/2" [2451]	100 1/2" [2553]	104 1/2" [2654]
<b>M.O. ADAMS/FLAT CASING</b>	99 9/16" [2529]	103 9/16" [2630]	107 9/16" [2732]
<b>ROUGH OPENING</b>	94" [2387]	98" [2493]	102" [2590]
<b>FRAME SIZE</b>	93 1/4" [2369]	97 1/4" [2470]	101 1/4" [2572]
<b>DAYLIGHT OPENING</b>	22 5/8" [575] (2) - 7 1/2" [190] (2)	22 5/8" [575] (2) - 9 1/2" [241] (2)	22 5/8" [575] (2) - 11 1/2" [292] (2)

84 3/8" [2143]  
85 7/8" [2181]  
83 1/4" [2114]  
82 1/2" [2096]  
68 1 1/16" [1745]

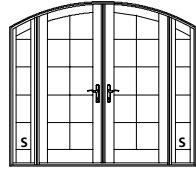

CIFRTS5468Q10

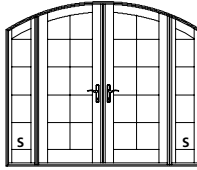

CIFRTS5468Q12

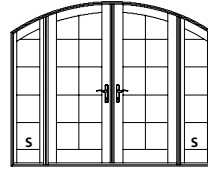

CIFRTS5468Q14

88 3/8" [2245]  
89 7/8" [2283]  
87 1/4" [2216]  
86 1/2" [2197]  
72 11/16" [1846]

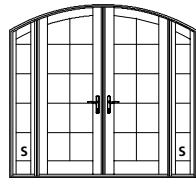

CIFRTS5470Q10

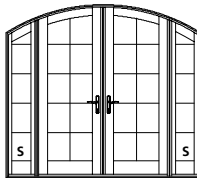

CIFRTS5470Q12

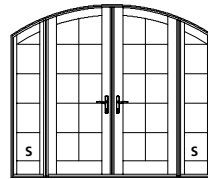

CIFRTS5470Q14

100 3/8" [2550]  
101 7/8" [2588]  
99 1/4" [2521]  
98 1/2" [2502]  
84 11/16" [2151]

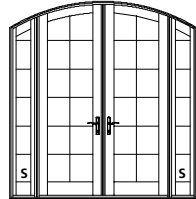

CIFRTS5480Q10

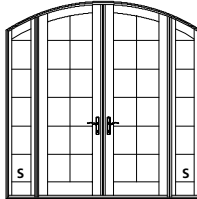

CIFRTS5480Q12

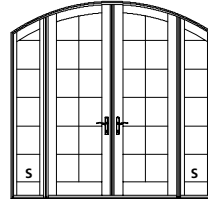

CIFRTS5480Q14

112 3/8" [2854]  
113 7/8" [2892]  
111 1/4" [2825]  
110 1/2" [2807]  
96 11/16" [2456]

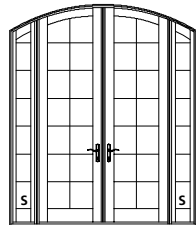

CIFRTS5490Q10

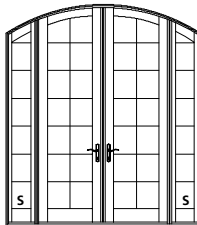

CIFRTS5490Q12

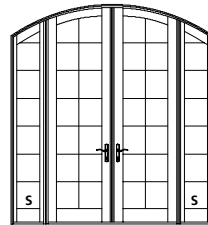

CIFRTS5490Q14

**ELEVATION SYMBOL LEGEND:**

**M.O.** = MASONRY OPENING  
VALUES IN [ ] ARE IN MILLIMETER CONVERSIONS  
VALUES IN ( ) ARE NUMBER OF DAYLIGHT OPENINGS PER UNIT  
**S** PANEL IS AVAILABLE AS STATIONARY ONLY.

Note: Elevations shown DO NOT have exterior trim. Subtract 1/2" (12.7) from M.O. (Masonry Opening) for Unit Size. For other Trim Options refer to the Unit Sizing, Rough Opening & Masonry Openings page.

SCALE: 1/8" = 1'

**FRENCH SECTOR TOP DOOR WITH TWO SIDELIGHTS**  
**6-0 UNITS**

**M.O. BRICKMOULD**  
**M.O. ADAMS/FLAT CASING**  
**ROUGH OPENING**  
**FRAME SIZE**  
**DAYLIGHT OPENING**

104 1/2" [2654]  
107 9/16" [2732]  
102" [2590]  
101 1/4" [2572]  
26 5/8" [676] (2) - 7 1/2" [190] (2)

108 1/2" [2756]  
111 9/16" [2834]  
106" [2692]  
105 1/4" [2673]  
26 5/8" [676] (2) - 9 1/2" [241] (2)

112 1/2" [2858]  
115 9/16" [2935]  
110" [2794]  
109 1/4" [2775]  
26 5/8" [676] (2) - 11 1/2" [292] (2)

84 3/8" [2143]  
85 7/8" [2181]  
83 1/4" [2114]  
82 1/2" [2096]  
68 11/16" [1745]

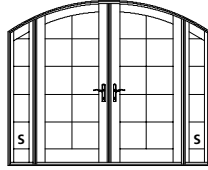

CIFRTS6068Q10

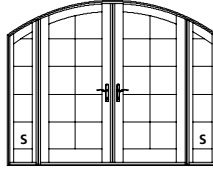

CIFRTS6068Q12

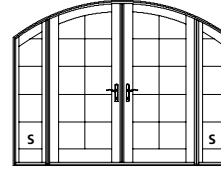

CIFRTS6068Q14

88 3/8" [2245]  
89 7/8" [2283]  
87 1/4" [2216]  
86 1/2" [2197]  
72 11/16" [1873]

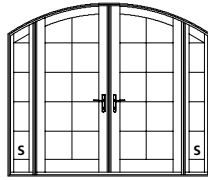

CIFRTS6070Q10

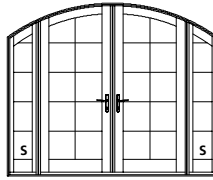

CIFRTS6070Q12

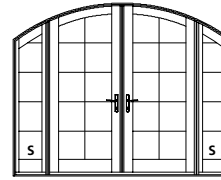

CIFRTS6070Q14

100 3/8" [2550]  
101 7/8" [2588]  
99 1/4" [2521]  
98 1/2" [2502]  
84 11/16" [2151]

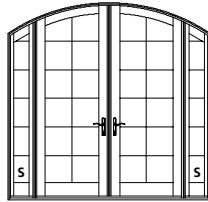

CIFRTS6080Q10

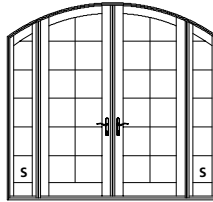

CIFRTS6080Q12

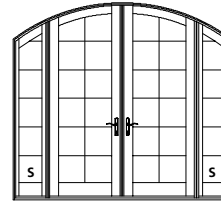

CIFRTS6080Q14

112 3/8" [2854]  
113 7/8" [2892]  
111 1/4" [2825]  
110 1/2" [2807]  
96 11/16" [2456]

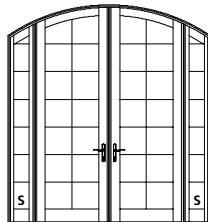

CIFRTS6090Q10

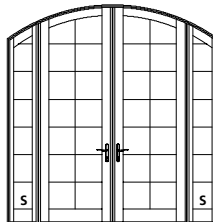

CIFRTS6090Q12

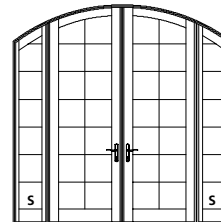

CIFRTS6090Q14

**ELEVATION SYMBOL LEGEND:**

**M.O.** = MASONRY OPENING  
VALUES IN [ ] ARE IN MILLIMETER CONVERSIONS  
VALUES IN ( ) ARE NUMBER OF DAYLIGHT OPENINGS PER UNIT  
**S** PANEL IS AVAILABLE AS STATIONARY ONLY.

Note: Elevations shown DO NOT have exterior trim. Subtract 1/2" (12.7) from M.O. (Masonry Opening) for Unit Size. For other Trim Options refer to the Unit Sizing, Rough Opening & Masonry Openings page.

SCALE: 1/8" = 1'

**FRENCH SECTOR TOP DOOR WITH TWO SIDELIGHTS**  
**7-0 UNITS**

**M.O. BRICKMOULD**  
**M.O. ADAMS/FLAT CASING**  
**ROUGH OPENING**  
**FRAME SIZE**  
**DAYLIGHT OPENING**

116 1/2" [2959]  
119 9/16" [3037]  
114" [2895]  
113 1/4" [2877]  
32 5/8" [829] (2) - 7 1/2" [190] (2)

120 1/2" [3061]  
123 9/16" [3138]  
118" [2997]  
117 1/4" [2978]  
32 5/8" [829] (2) - 9 1/2" [241] (2)

124 1/2" [3162]  
127 9/16" [3240]  
122" [3098]  
121 1/4" [3080]  
32 5/8" [829] (2) - 11 1/2" [292] (2)

84 3/8" [2143]  
85 7/8" [2181]  
83 1/4" [2114]  
82 1/2" [2096]  
68 11/16" [1745]

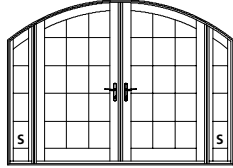

CIFRTS7068Q10

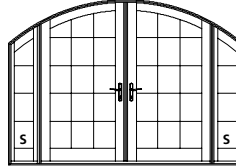

CIFRTS7068Q12

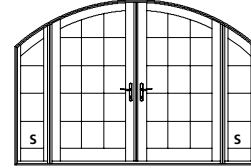

CIFRTS7068Q14

88 3/8" [2245]  
89 7/8" [2283]  
87 1/4" [2216]  
86 1/2" [2197]  
72 11/16" [1846]

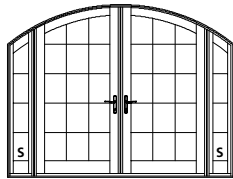

CIFRTS7070Q10

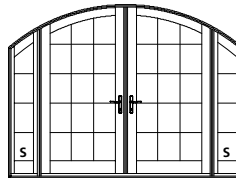

CIFRTS7070Q12

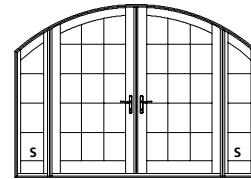

CIFRTS7070Q14

100 3/8" [2550]  
101 7/8" [2588]  
99 1/4" [2521]  
98 1/2" [2502]  
84 11/16" [2151]

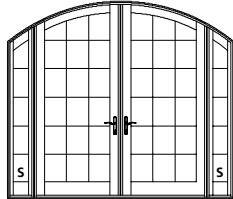

CIFRTS7080Q10

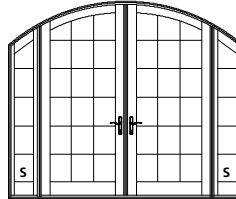

CIFRTS7080Q12

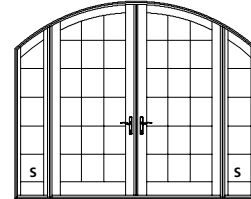

CIFRTS7080Q14

**ELEVATION SYMBOL LEGEND:**

**M.O.** = MASONRY OPENING  
VALUES IN [ ] ARE IN MILLIMETER CONVERSIONS  
VALUES IN ( ) ARE NUMBER OF DAYLIGHT OPENINGS PER UNIT  
**S** PANEL IS AVAILABLE AS STATIONARY ONLY.

Note: Elevations shown DO NOT have exterior trim. Subtract 1/2" (12.7) from M.O. (Masonry Opening) for Unit Size. For other Trim Options refer to the Unit Sizing, Rough Opening & Masonry Openings page.

**SECTOR TOP TRANSOM UNITS**

**M.O. BRICKMOULD**  
**M.O. ADAMS/FLAT CASING**  
**ROUGH OPENING**  
**FRAME SIZE**  
**DAYLIGHT OPENING**

28 11/16" [729]  
31 3/4" [806]  
26 3/16" [665]  
25 7/16" [646]  
14 5/8" [371]

34 11/16" [881]  
37 3/4" [959]  
32 3/16" [818]  
31 7/16" [799]  
20 5/8" [524]

36 11/16" [932]  
39 3/4" [1010]  
34 3/16" [868]  
33 7/16" [849]  
22 5/8" [575]

40 11/16" [1033]  
43 3/4" [1111]  
38 3/16" [970]  
37 7/16" [951]  
26 5/8" [676]

22 1/2" [572]  
24" [607]  
20 3/4" [527]  
20" [508]  
12 15/16" [329]



CTISWTS2018



CTISWTS2618



CTISWTS2818



CTISWTS3018

32 1/2" [826]  
34" [864]  
30 3/4" [781]  
30" [762]  
22 15/16" [583]



CTISWTS2026



CTISWTS2626



CTISWTS2826



CTISWTS3026

**M.O. BRICKMOULD**  
**M.O. ADAMS/FLAT CASING**  
**ROUGH OPENING**  
**FRAME SIZE**  
**DAYLIGHT OPENING**

53 7/8" [1368]  
56 15/16 [1446]  
51 3/8" [1304]  
50 5/8 [1286]  
39 13/16" [1011]

65 7/8" [1673]  
68 15/16" [1751]  
63 3/8" [1610]  
62 5/8" [1591]  
51 13/16" [1316]

69 7/8" [1775]  
72 15/16" [1853]  
67 3/8" [1711]  
66 5/8" [1692]  
55 13/16" [1418]

77 7/8" [1978]  
80 15/16" [2056]  
75 3/8" [1914]  
74 5/8" [1895]  
63 13/16" [1621]

22 1/2" [572]  
24" [607]  
20 3/4" [527]  
20" [508]  
12 15/16" [329]

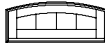

CTIFRTS4018



CTIFRTS5018



CTIFRTS5418



CTIFRTS6018

32 1/2" [826]  
34" [864]  
30 3/4" [781]  
30" [762]  
22 15/16" [583]

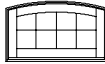

CTIFRTS4026

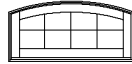

CTIFRTS5026

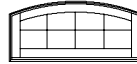

CTIFRTS5426

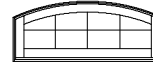

CTIFRTS6026

**ELEVATION SYMBOL LEGEND:**

**M.O.** = MASONRY OPENING  
VALUES IN [ ] ARE IN MILLIMETER CONVERSIONS

Note: Vertical Masonry Opening sizes are shown for units with 4-9/16" jamb. For transom units with 6-9/16" jamb subtract 1/8" from the finished dimensions.

Note: Elevations shown DO NOT have exterior trim. Subtract 1/2" (12.7) from M.O. (Masonry Opening) for Unit Sizes. Masonry Openings above include Sill Nose, see Transom Rail & Sill Options page for Sill Nose specifications. For other Trim Options refer to the Unit Sizing, Rough Opening & Masonry Openings page.

SCALE: 1/8" = 1'



**GLAZING OPTIONS**

**INTERIOR GLAZED**  
INSULATED 3/4" [19] GLASS

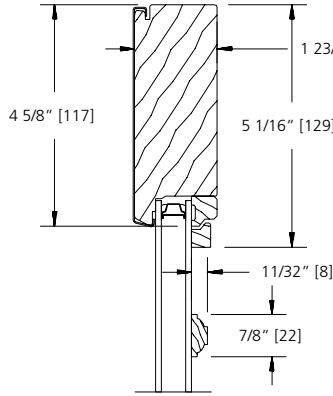

**7/8" FULL SURROUND**

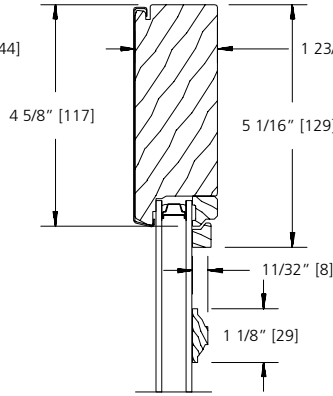

**1 1/8" FULL SURROUND**

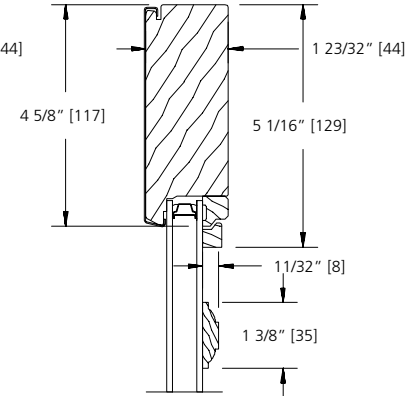

**1 3/8" FULL SURROUND**

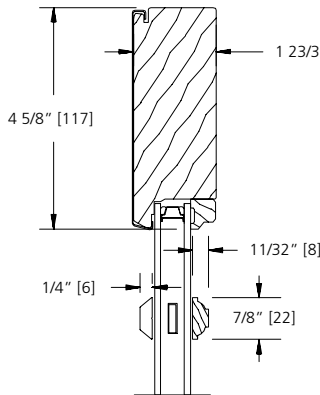

**7/8" SDL BAR  
(PUTTY LINE)**

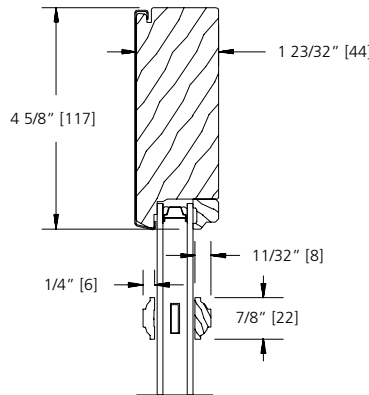

**7/8" SDL BAR  
(BEAD STOP)**

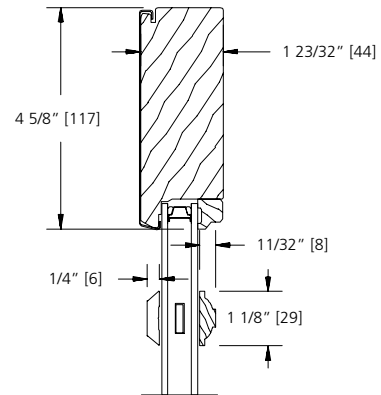

**1 1/8" SDL BAR  
(PUTTY LINE)**

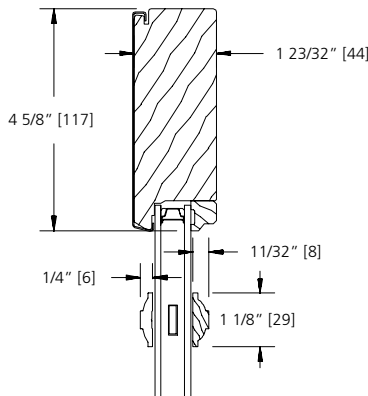

**1 1/8" SDL BAR  
(BEAD STOP)**

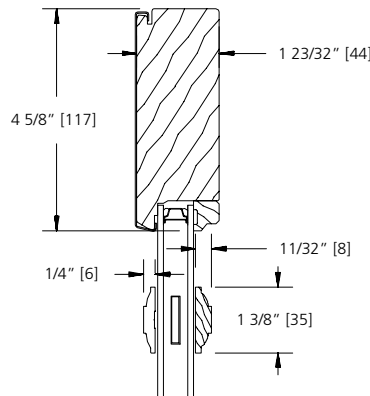

**1 3/8" SDL BAR  
(BEAD STOP)**

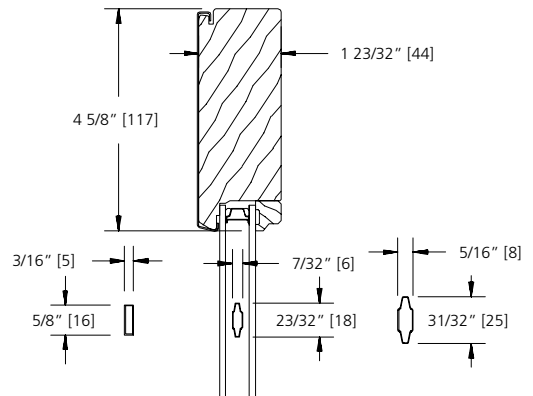

**5/8" FLAT GBG**

**23/32" CONTOUR GBG**

**1" CONTOUR GBG**

SCALE: 3" = 1'

**GLAZING OPTIONS**

**INTERIOR GLAZED**  
SINGLE 1/8" [3] GLASS

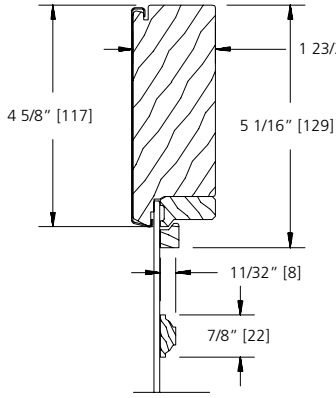

**7/8" FULL SURROUND**

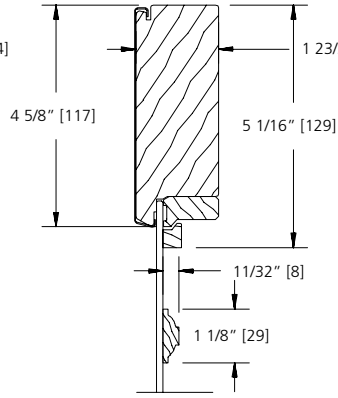

**1 1/8" FULL SURROUND**

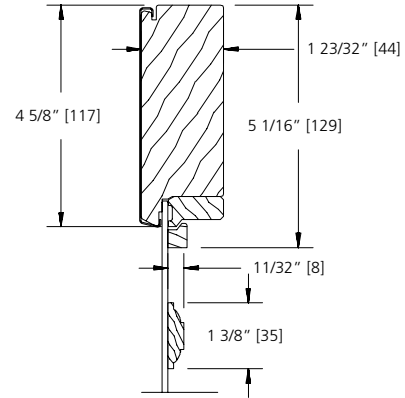

**1 3/8" FULL SURROUND**

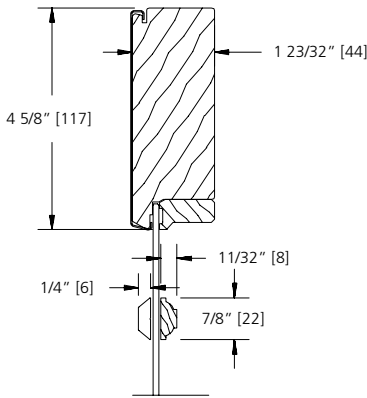

**7/8" SDL BAR  
(PUTTY LINE)**

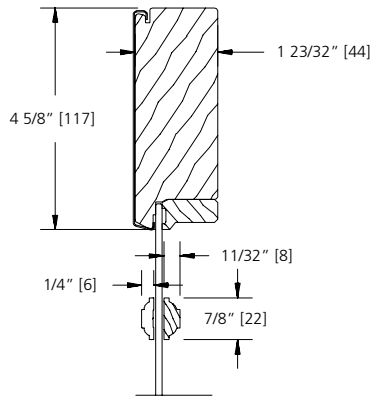

**7/8" SDL BAR  
(BEAD STOP)**

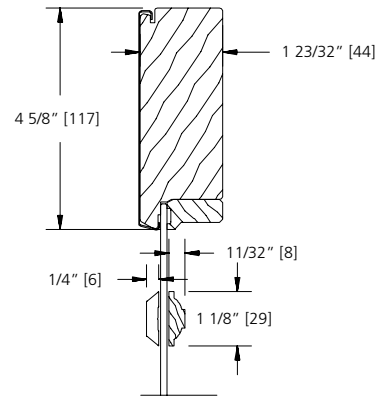

**1 1/8" SDL BAR  
(PUTTY LINE)**

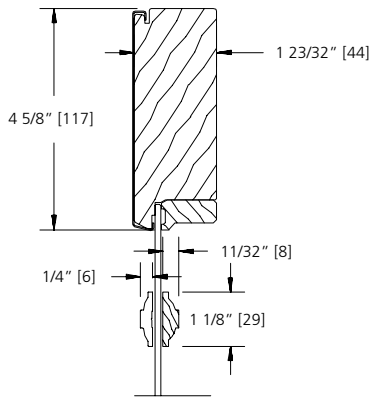

**1 1/8" SDL BAR  
(BEAD STOP)**

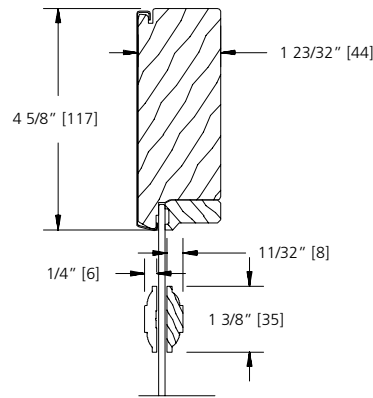

**1 3/8" SDL BAR  
(BEAD STOP)**

SCALE: 3" = 1'

**GLAZING OPTIONS**

**INTERIOR GLAZED**  
IMPACT RESISTANT GLASS

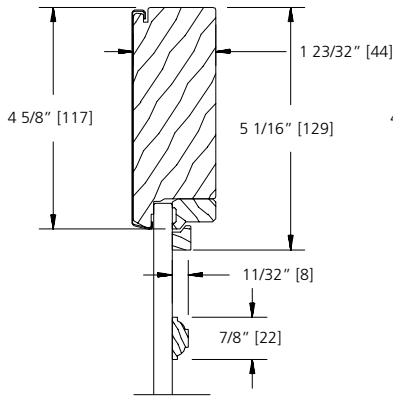

**7/8" FULL SURROUND**

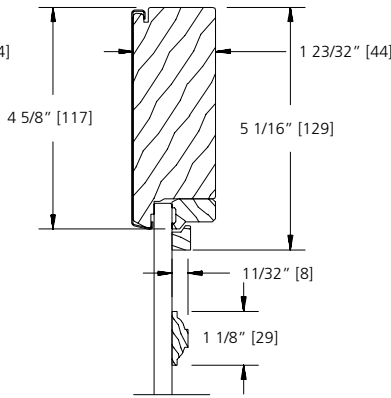

**1 1/8" FULL SURROUND**

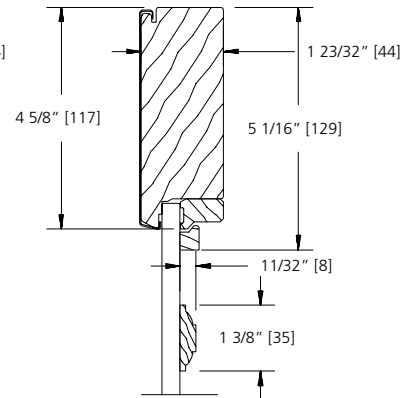

**1 3/8" FULL SURROUND**

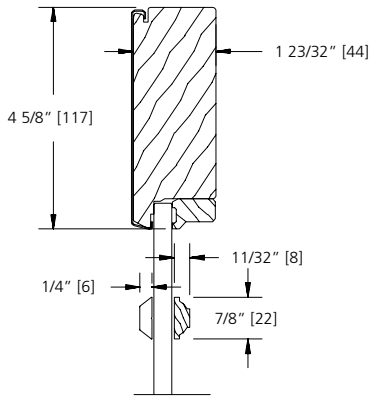

**7/8" SDL BAR  
(PUTTY LINE)**

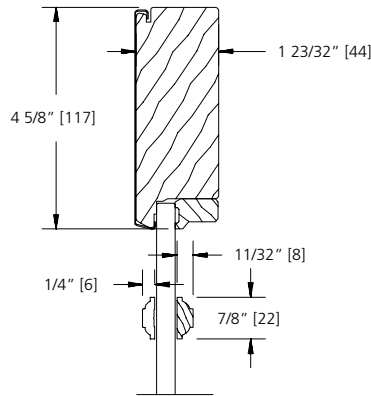

**7/8" SDL BAR  
(BEAD STOP)**

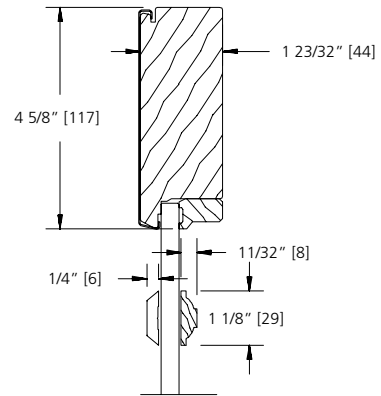

**1 1/8" SDL BAR  
(PUTTY LINE)**

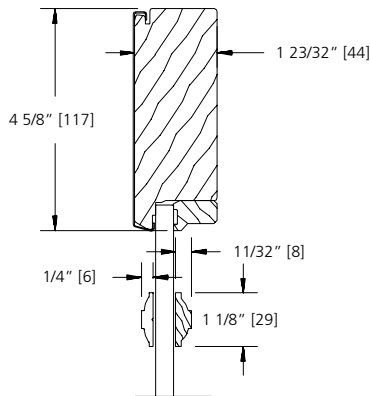

**1 1/8" SDL BAR  
(BEAD STOP)**

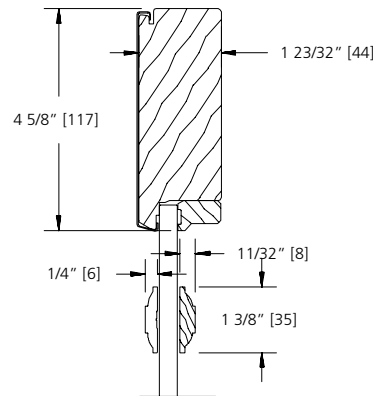

**1 3/8" SDL BAR  
(BEAD STOP)**

SCALE: 3" = 1'

**TRIM OPTIONS**

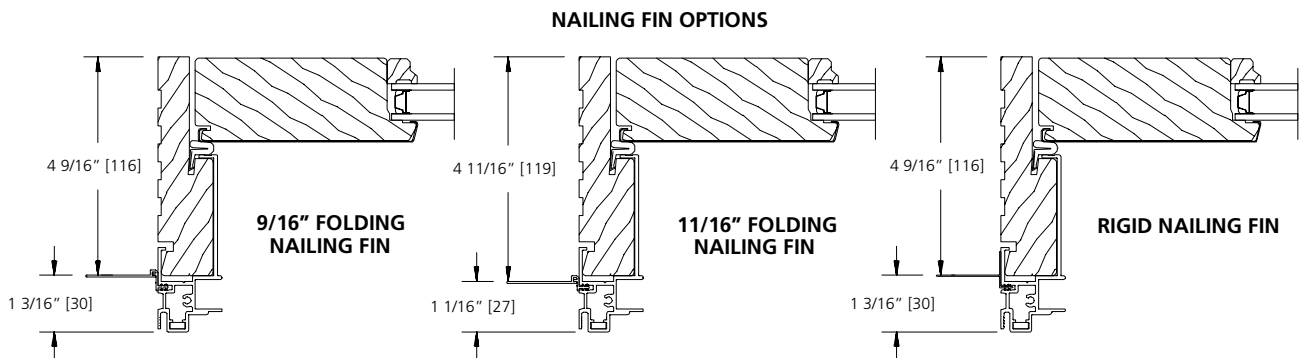
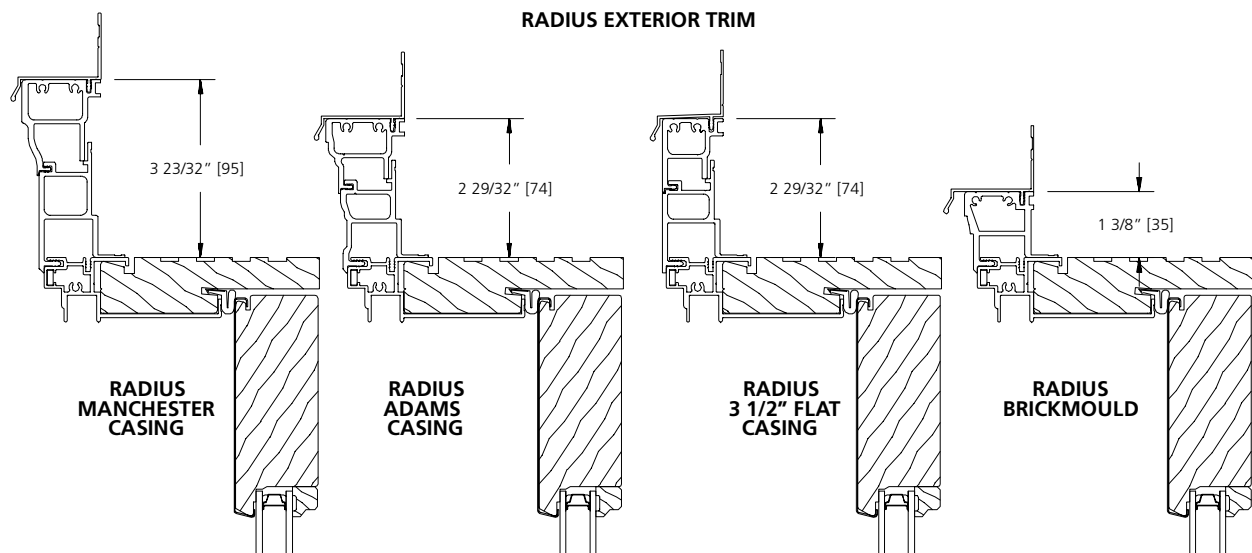
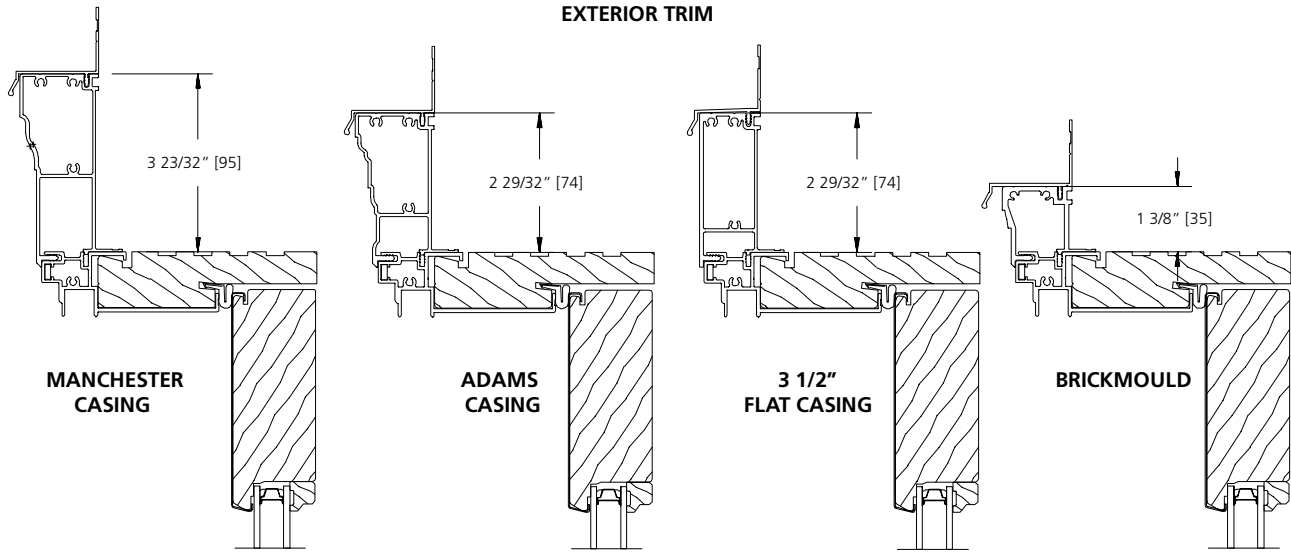

NOTE: 11/16\"/>

SCALE: 3\"/>

**RAIL, PANEL & SILL OPTIONS**

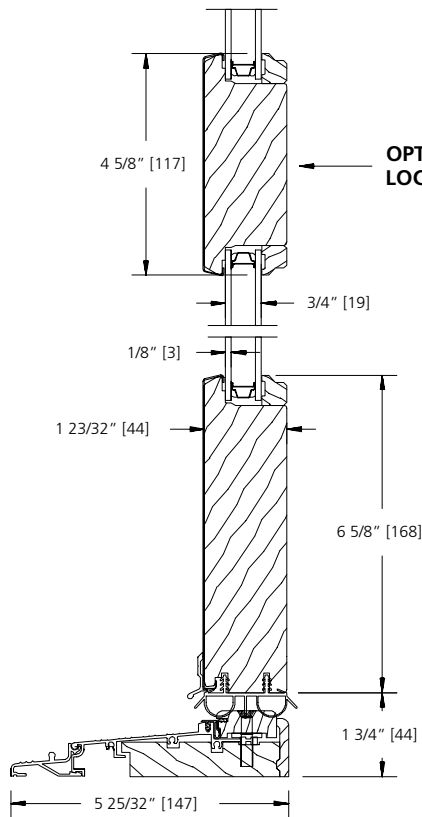

**STANDARD 6 5/8" BOTTOM RAIL  
STANDARD SILL (4 9/16 JAMB)**

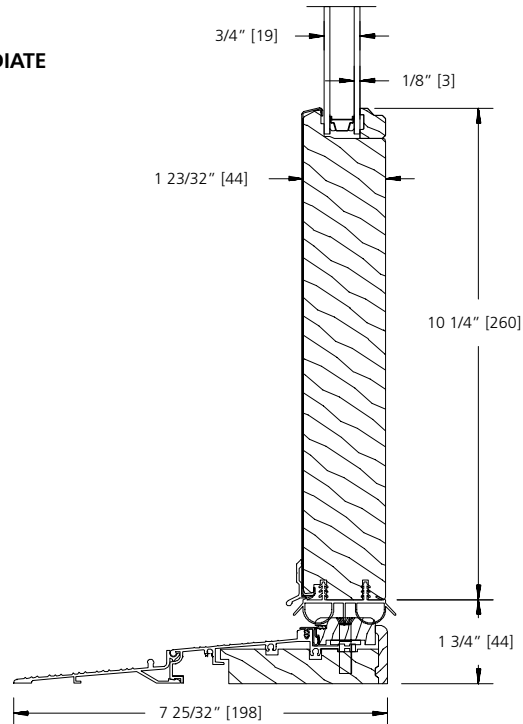

**OPTIONAL 10 1/4" BOTTOM RAIL  
SILL EXTENSION (6 9/16 JAMB)**

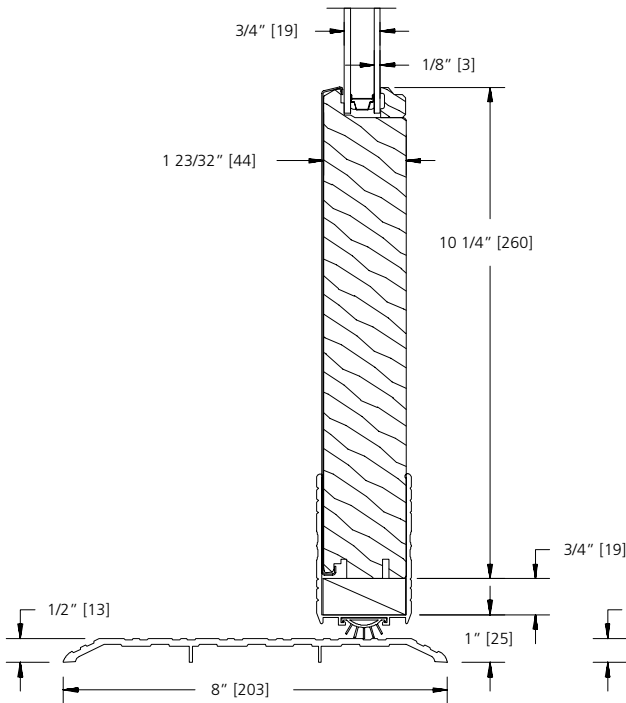

**OPTIONAL 10 1/4" BOTTOM RAIL  
HANDICAP SILL (4 9/16 JAMB)**

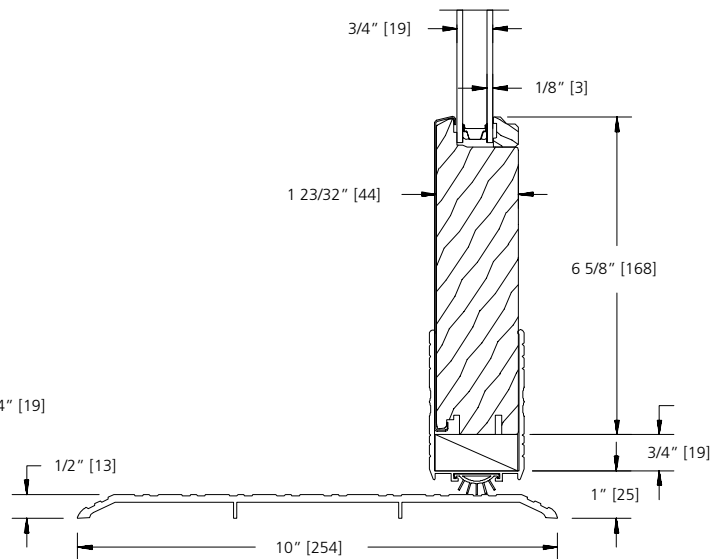

**STANDARD 6 5/8" BOTTOM RAIL  
HANDICAP SILL (6 9/16 JAMB)**

SCALE: 3" = 1'

**RAIL, PANEL & SILL OPTIONS**

**TRANSOM**

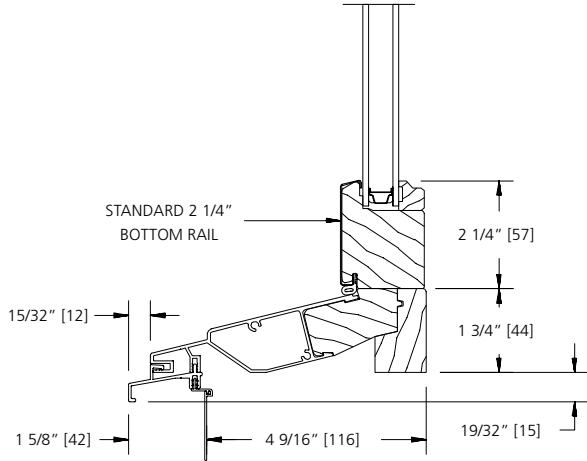

**TRANSOM  
SILL NOSE  
(4 9/16" JAMB)**

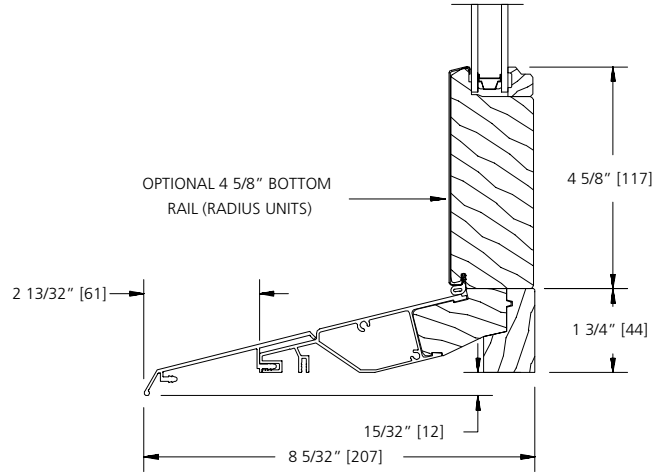

**TRANSOM  
2" SILL EXTENSION  
(6 9/16" JAMB)**

NOTE: SILL NOSE CAN BE USED WITH ALL STANDARD TRIM OPTIONS.

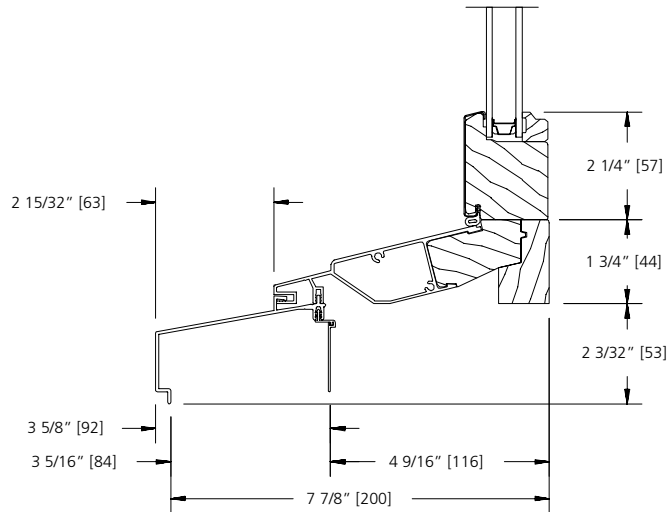

**TRANSOM  
EXTENDED SILL NOSE  
(4 9/16" JAMB)**

SCALE: 3" = 1'

**RAIL, PANEL & SILL OPTIONS**

**STANDARD RAISED PANEL OPTIONS**

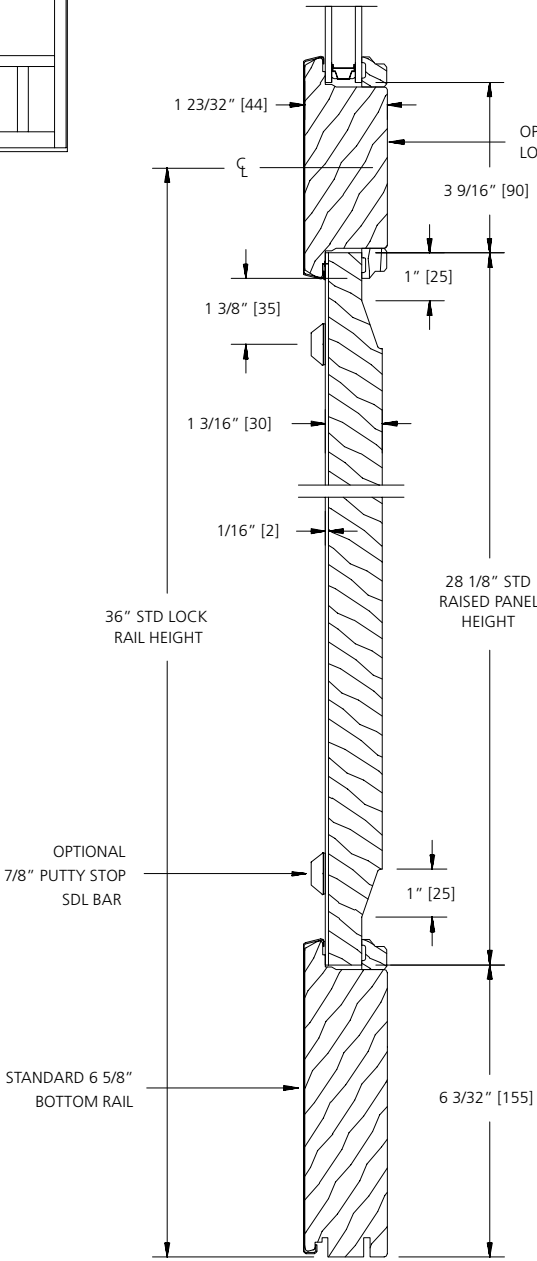
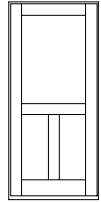

**VERTICAL SECTION**

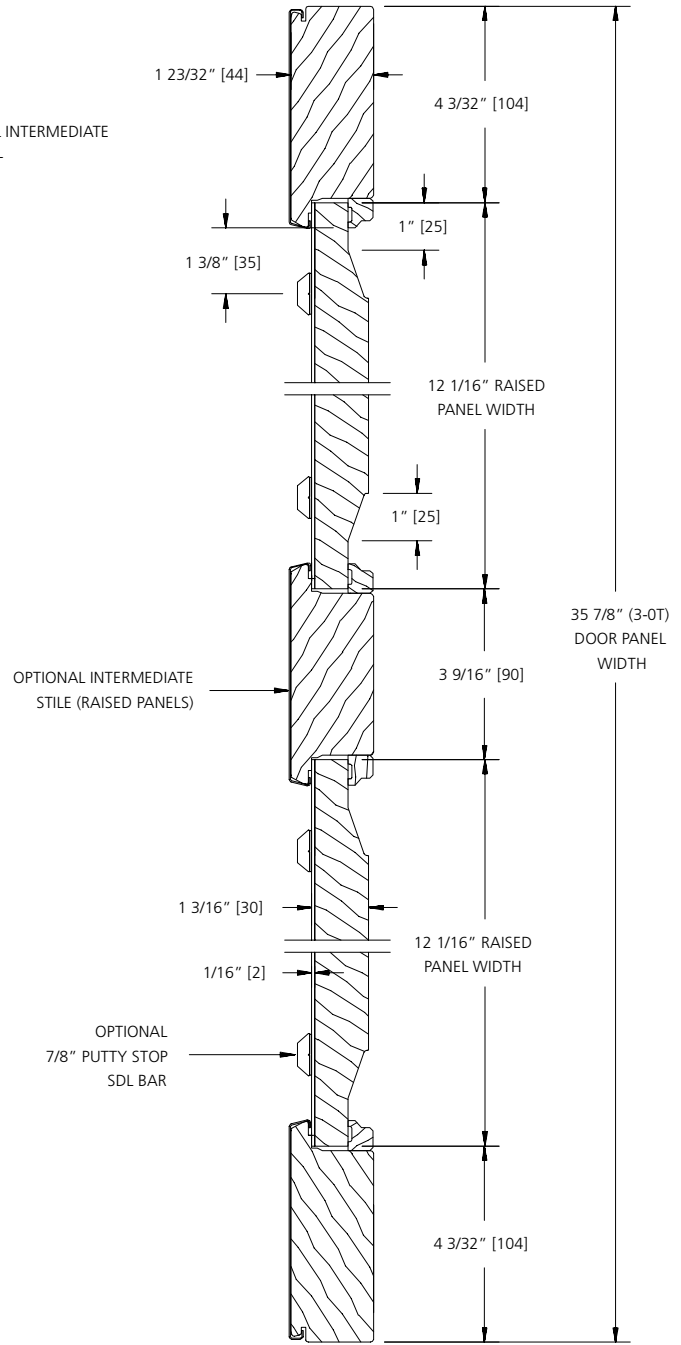

**HORIZONTAL SECTION**

SCALE: 3" = 1'

**RAIL, PANEL & SILL OPTIONS**

**OPTIONAL RAISED PANEL OPTIONS**

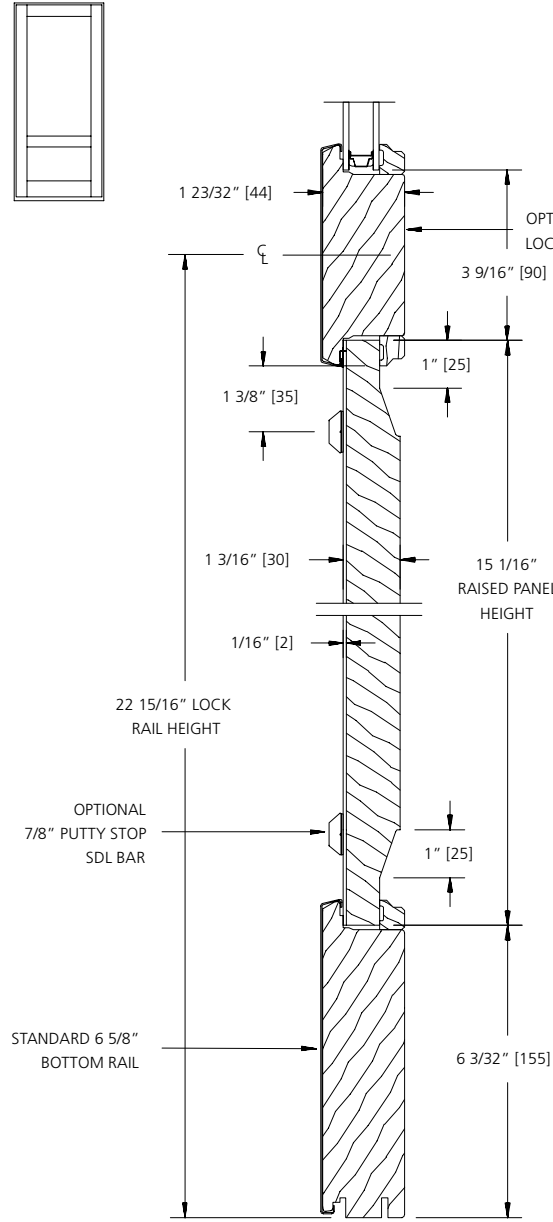
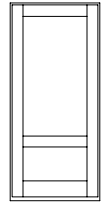

**VERTICAL SECTION**

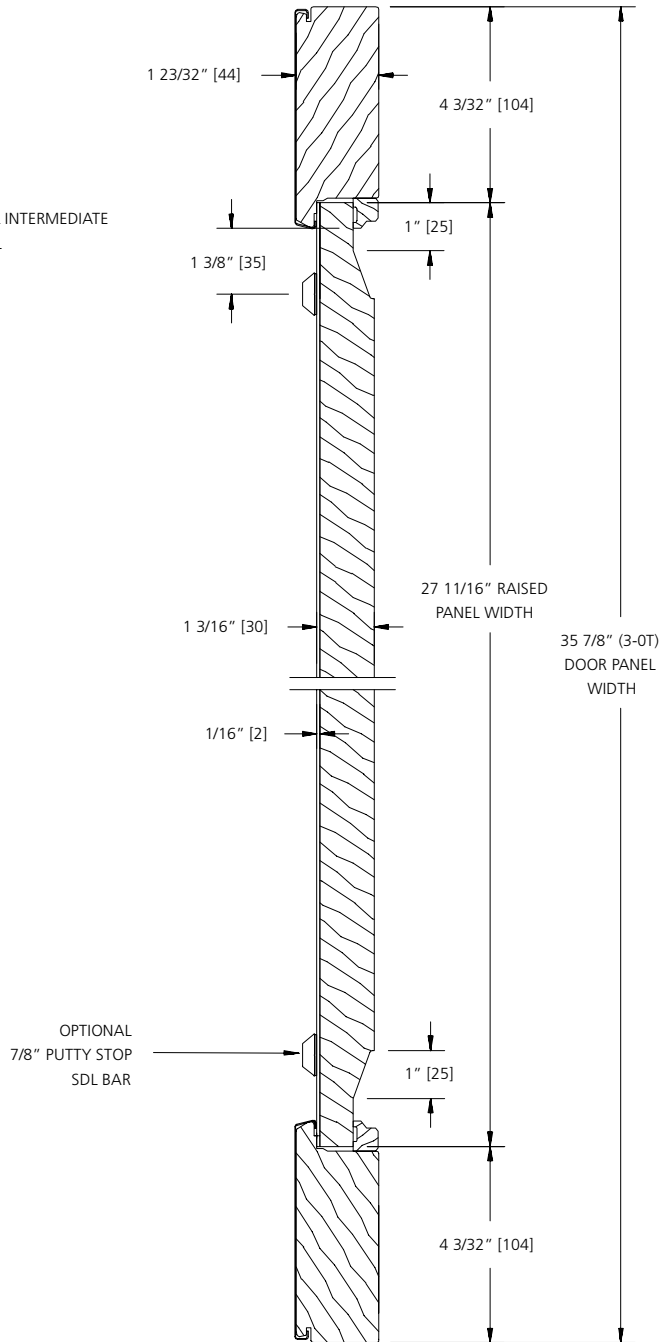

**HORIZONTAL SECTION**

SCALE: 3" = 1'



STANDARD MULLION DETAILS

4 9/16" JAMB

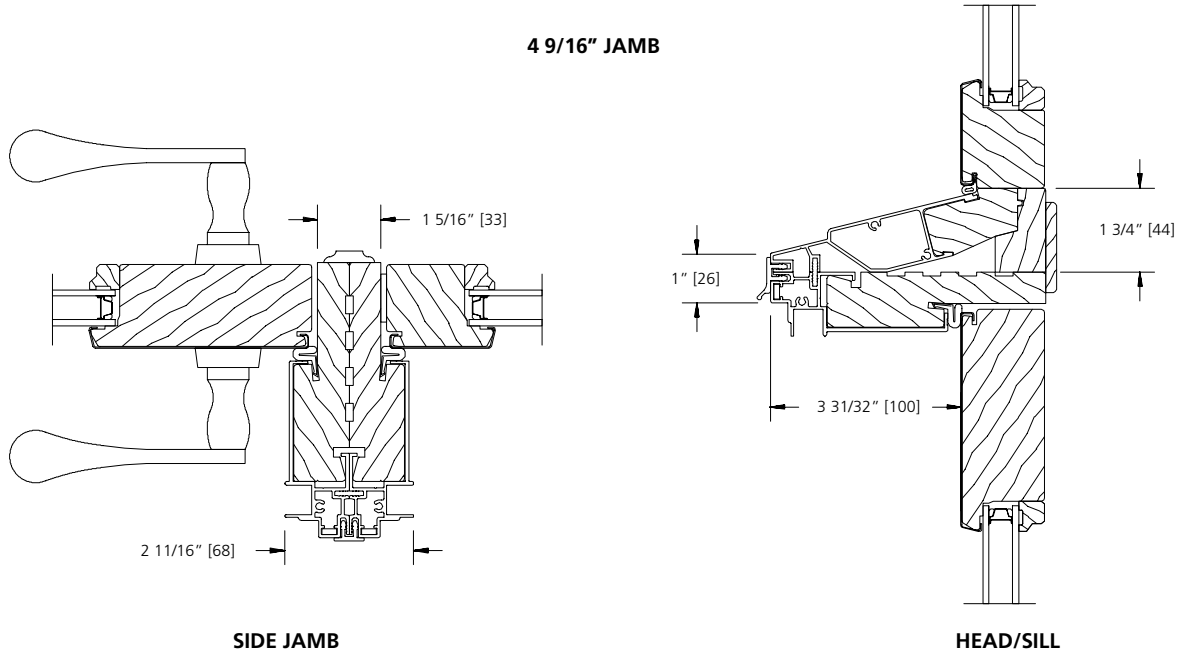

6 9/16" JAMB

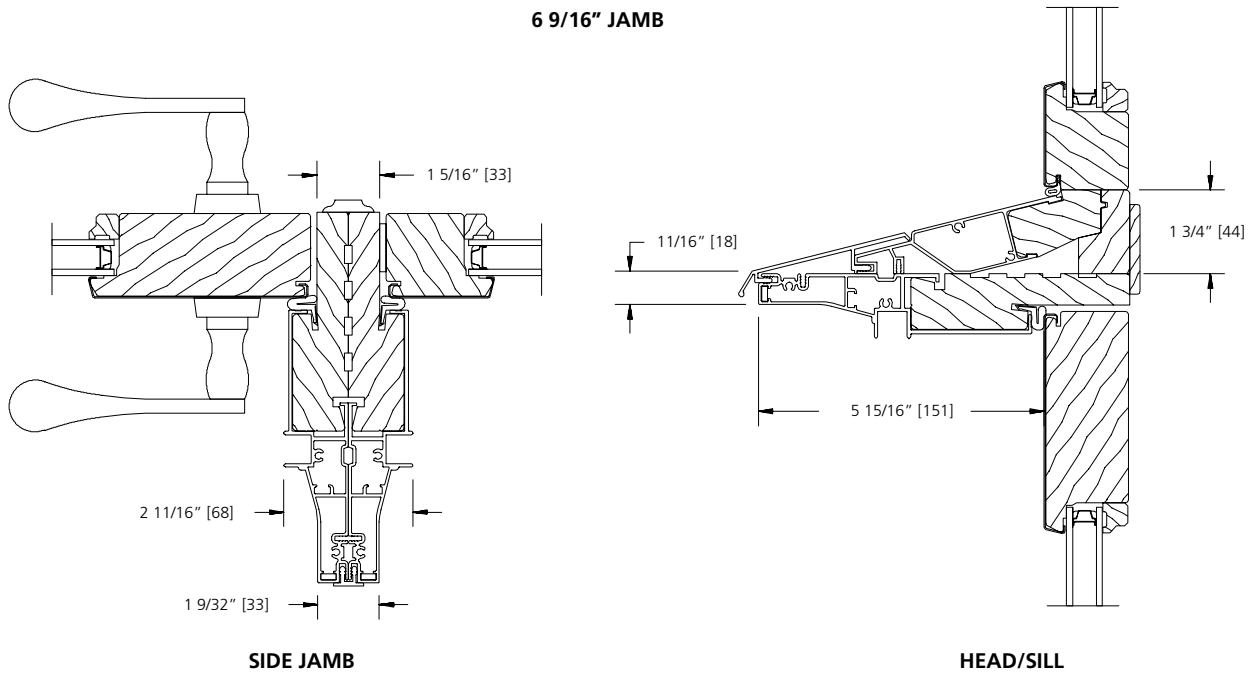

SCALE: 3" = 1'

**LITE CUT INFORMATION**

Clad in-swing patio doors are available with removable grilles in 7/8", 1-1/8" and 1-3/8" widths, with GBG (Grilles between the Glass), or with Simulated Divided Lites. Standard lite cuts are rectangular.

**LITE CUT OPTIONS**

Special lite cut patterns can include a wide variety of straight line and radius patterns. The illustrations shown here represent just a few of the possibilities. Rectangular, horizontal, vertical and Prairie lite patterns are available in all standard size clad swinging patio doors. Uneven, diamond, radius and Gothic lite cuts are available, subject to approval. Approvals are based on the ability to fulfill the design requirement while maintaining the construction integrity of the finished product.

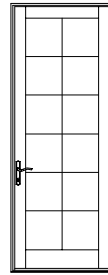

RECTANGULAR

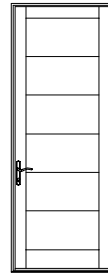

HORIZONTAL

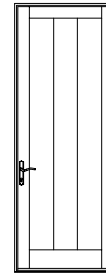

VERTICAL

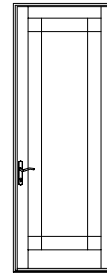

PRAIRIE

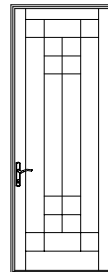

UNEVEN

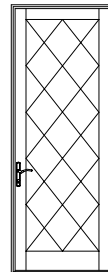

DIAMOND

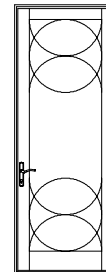

RADIUS

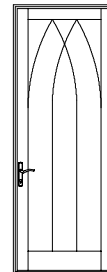

GOthic

**BAR ALIGNMENT**

Alignment of divided lite muntin bars from one product to the next is often required by fine architectural design. Wood grilles, GBG (Grilles between the Glass), and Simulated Divided Lights may be specified with muntin bars aligned.

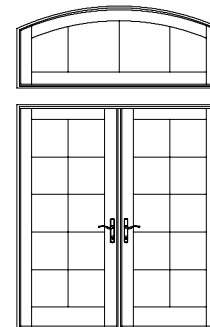
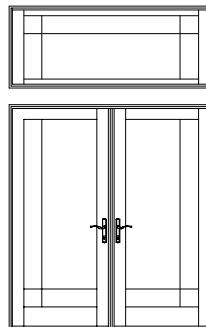

**CLEAR OPENING LAYOUT**

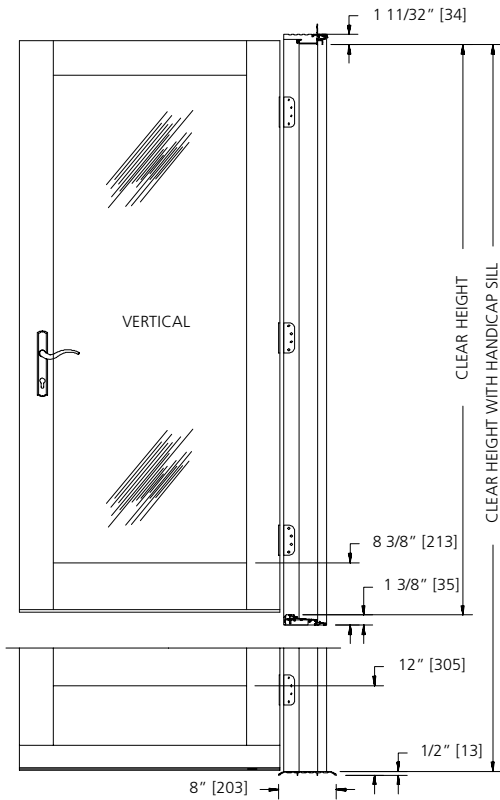

**Vertical**  
Standard sill  
Frame - 2 23/32" = Clear height  
Handicap sill  
Frame - 1 27/32" = Clear height

Daylight opening height at bottom rail to handicap sill is 12" with 10-1/4" bottom rail, and 8-3/8" with standard bottom rail.

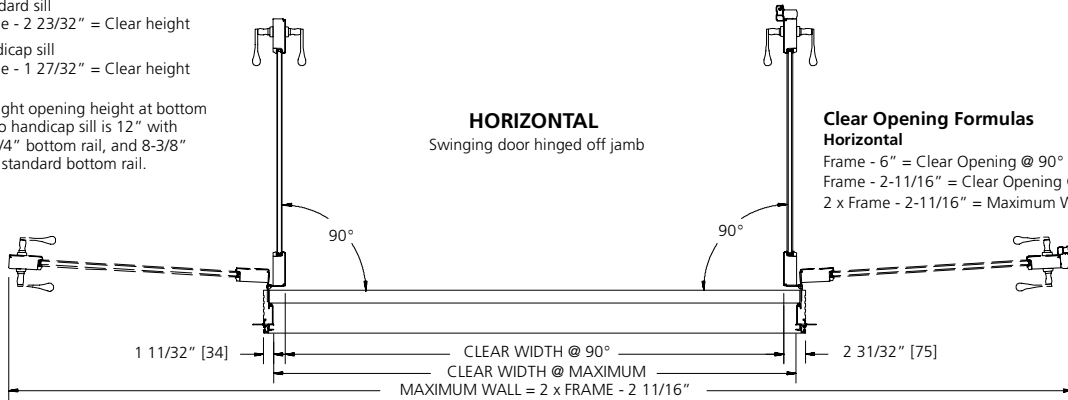
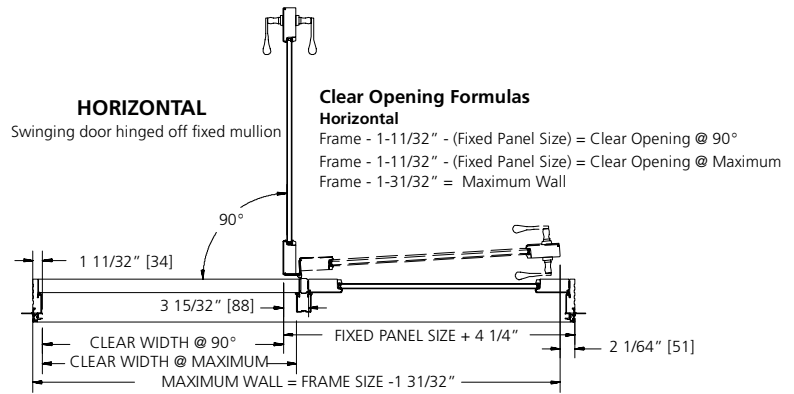
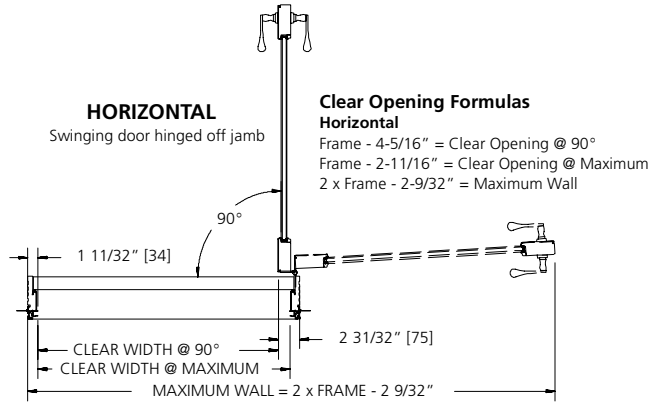

Panel Callout	Panel Width
2-0 Retro	21-7/8
2-6 Retro	27-7/8
2-8 Retro	29-7/8
3-0 Retro	33-7/8
2-0 True	23-7/8
2-6 True	29-7/8
2-8 True	31-7/8
3-0 True	35-7/8
3-6 True	41-7/8

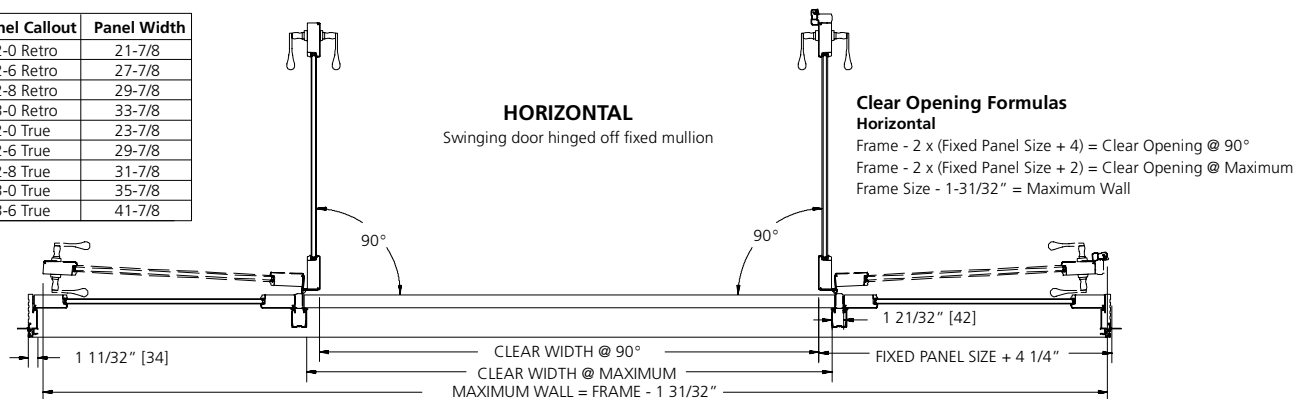





**CLEAR OPENING LAYOUT  
RADIUS**

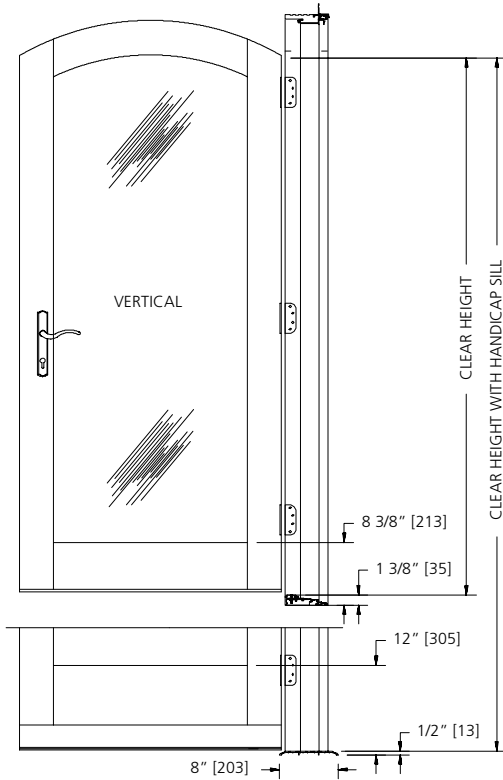

**Vertical**  
Radius head clear opening height varies with unit width - see table.

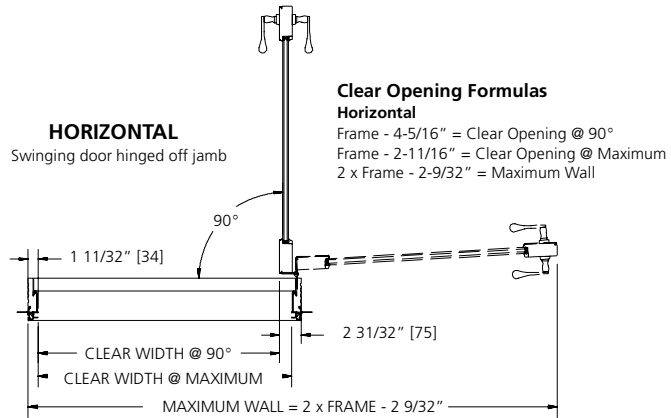

**Clear Opening Formulas**  
**Horizontal**  
Frame - 4-5/16" = Clear Opening @ 90°  
Frame - 2-11/16" = Clear Opening @ Maximum  
2 x Frame - 2-9/32" = Maximum Wall

Daylight opening height at bottom rail to handicap sill is 12" with 10-1/4" bottom rail, and 8-3/8" with standard bottom rail.

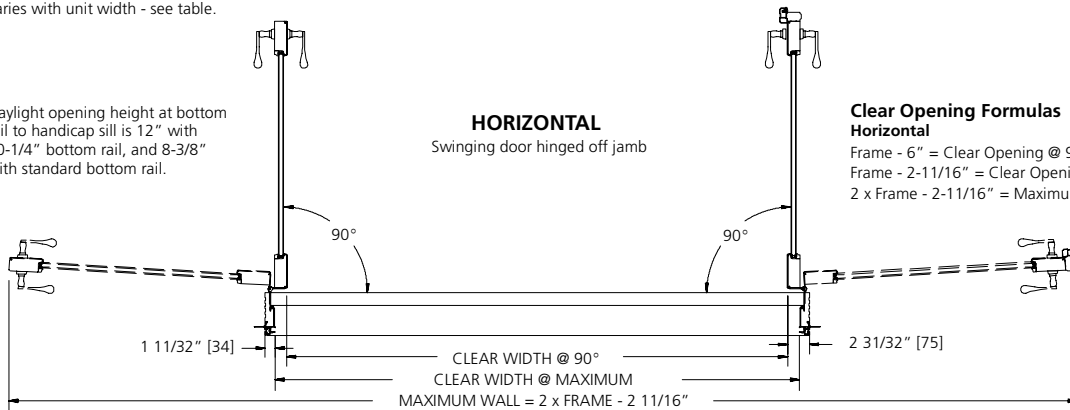

**Clear Opening Formulas**  
**Horizontal**  
Frame - 6" = Clear Opening @ 90°  
Frame - 2-11/16" = Clear Opening @ Maximum  
2 x Frame - 2-11/16" = Maximum Wall

Panel Callout	Panel Width
2-0 True	23-7/8
2-6 True	29-7/8
2-8 True	31-7/8
3-0 True	35-7/8
3-6 True	41-7/8

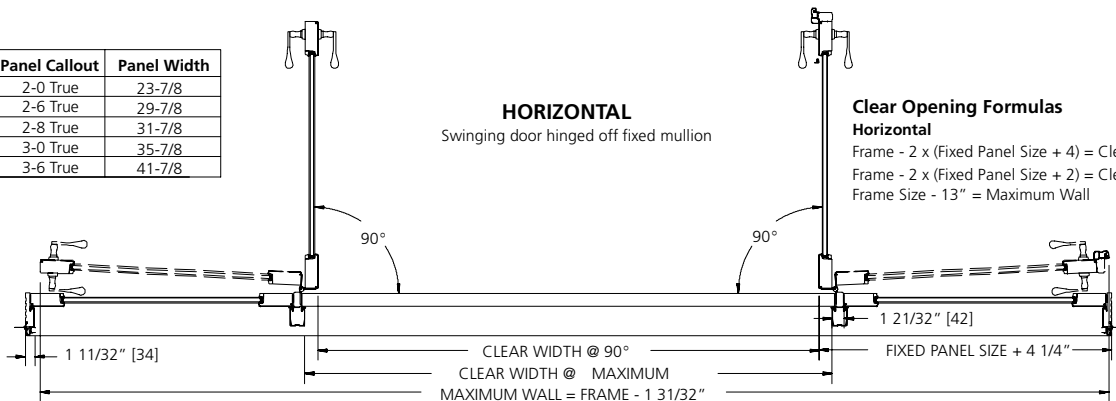

**Clear Opening Formulas**  
**Horizontal**  
Frame - 2 x (Fixed Panel Size + 4) = Clear Opening @ 90°  
Frame - 2 x (Fixed Panel Size + 2) = Clear Opening @ Maximum  
Frame Size - 13" = Maximum Wall



**UNIT SIZING, ROUGH OPENINGS  
& MASONRY OPENINGS**

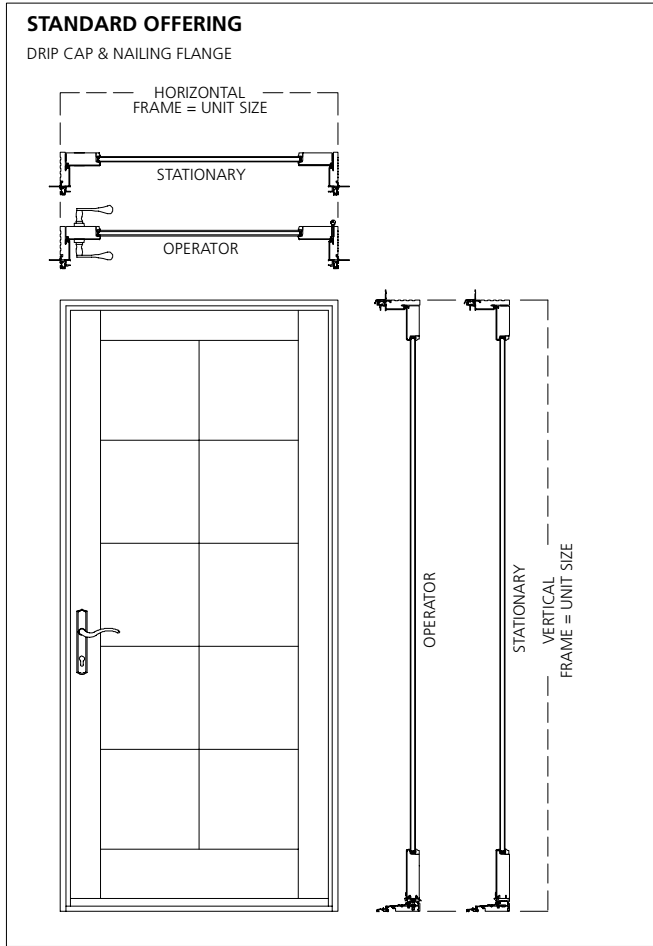

**GENERAL NOTES:**

UNITS WITH NO EXTERIOR TRIM  
OR DRIP CAP & NAILING FLANGE:  
FRAME SIZE = UNIT SIZE

UNIT SIZE IS ALWAYS THE  
EXTREME SIZE OF THE DOOR  
WITH OR WITHOUT TRIM  
(DRIP CAP & NAILING FLANGE ARE  
NOT ADDED TO ANY UNIT SIZING)

ROUGH OPENING IS ALWAYS 3/4" OVER  
FRAME SIZE OF THE DOOR

MASONRY OPENING IS ALWAYS 1/2"  
OVER THE UNIT SIZE OF THE DOOR

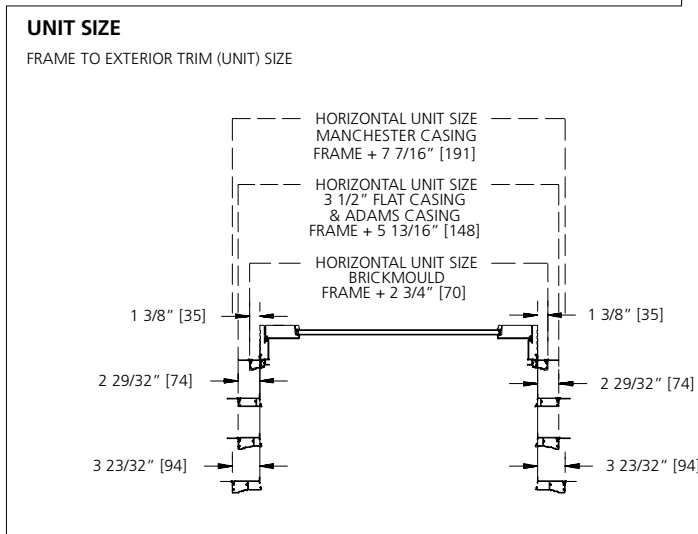
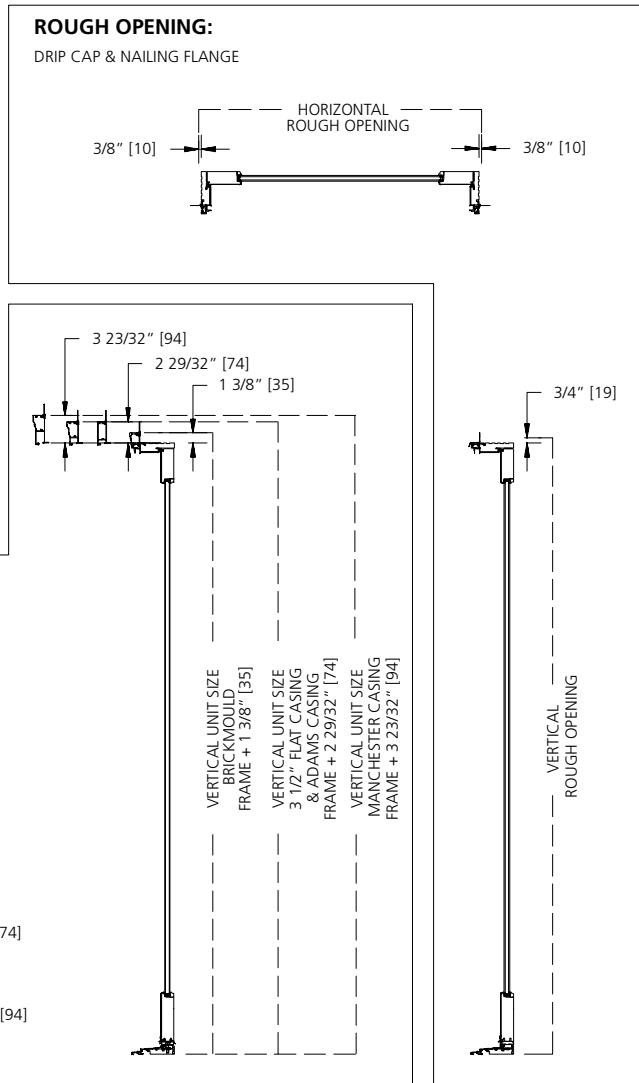



**1-PANEL OPERATING UNIT**

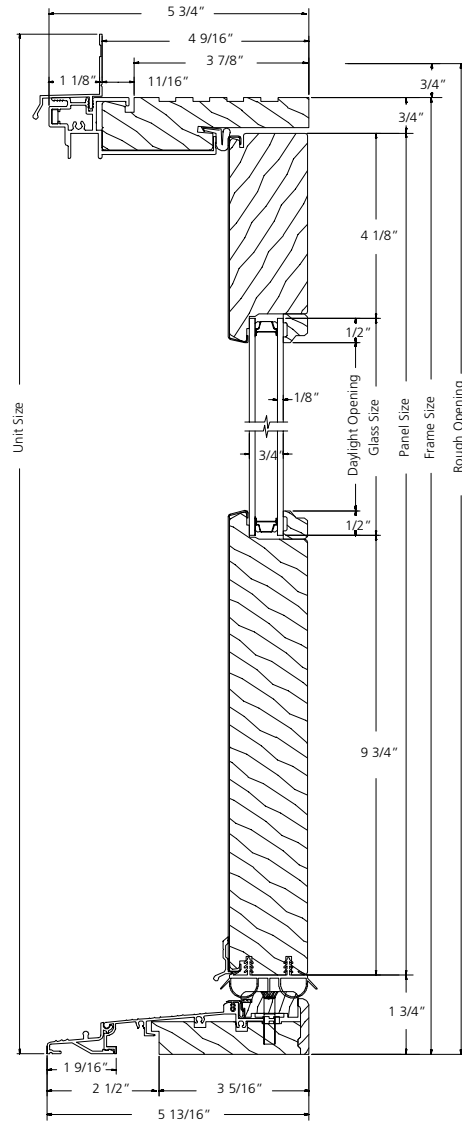

**VERTICAL SECTION**

SCALE: 3" = 1'

**1-PANEL OPERATING UNIT**

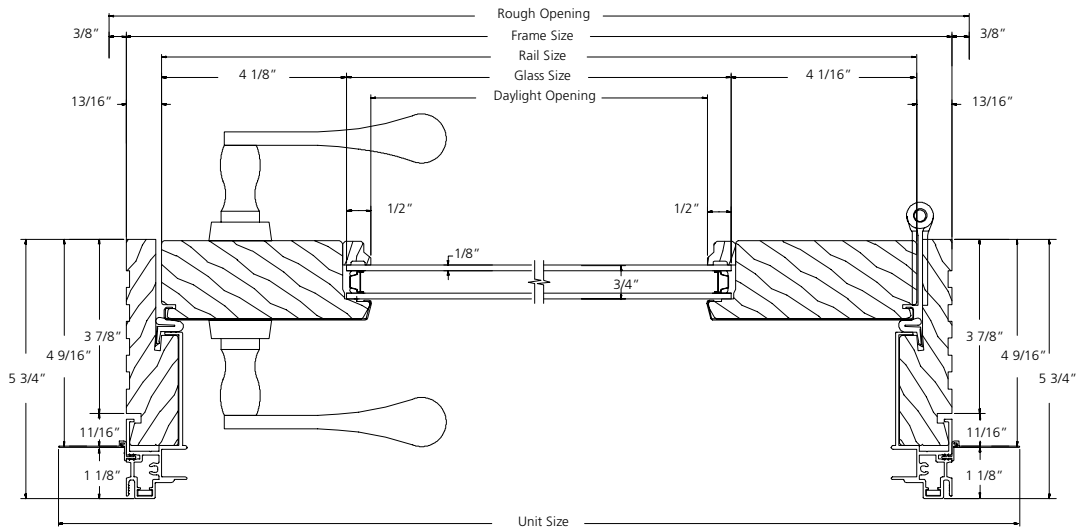

**HORIZONTAL SECTION**

SCALE: 3" = 1'

**2-PANEL UNIT**

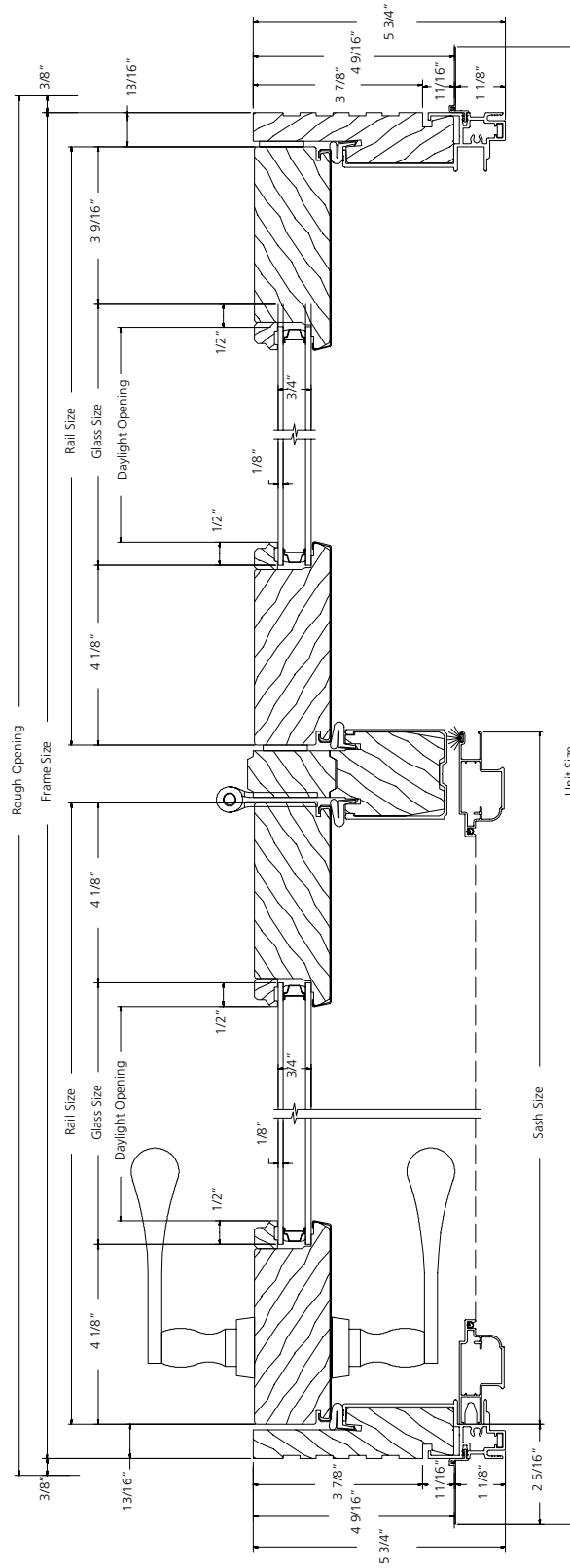

**HORIZONTAL SECTION**

SCALE: 3" = 1'

**3-PANEL UNIT**

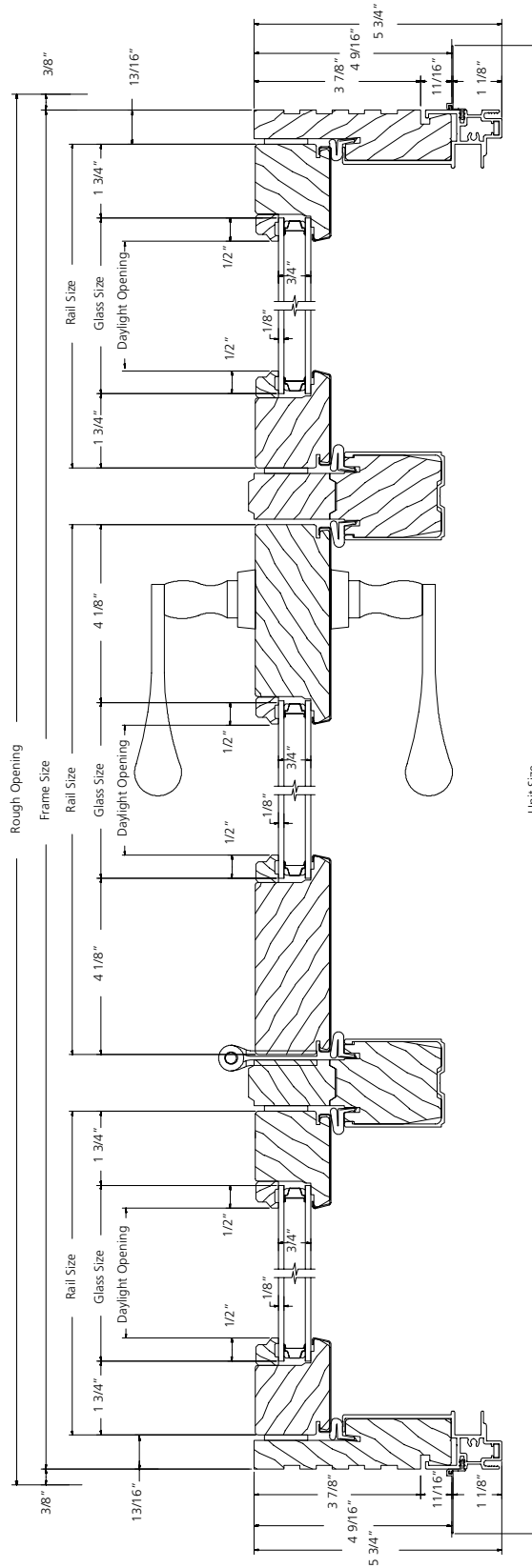

**HORIZONTAL SECTION**

SCALE: 3" = 1'

**2-PANEL FRENCH UNIT**

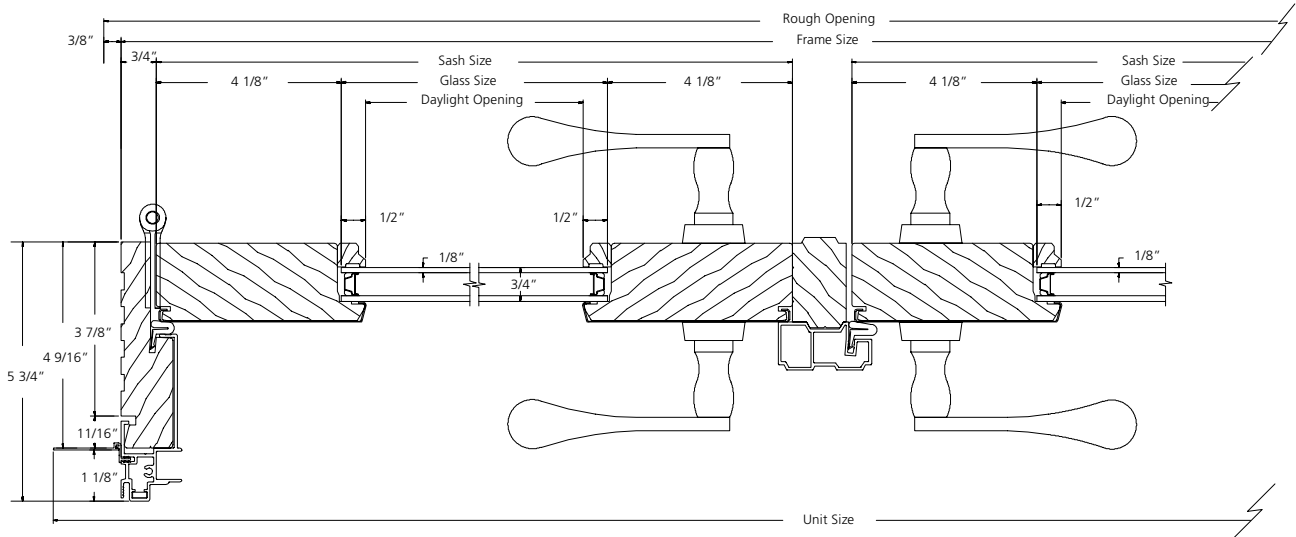

**HORIZONTAL SECTION**

SCALE: 3" = 1'

**4-PANEL FRENCH UNIT**

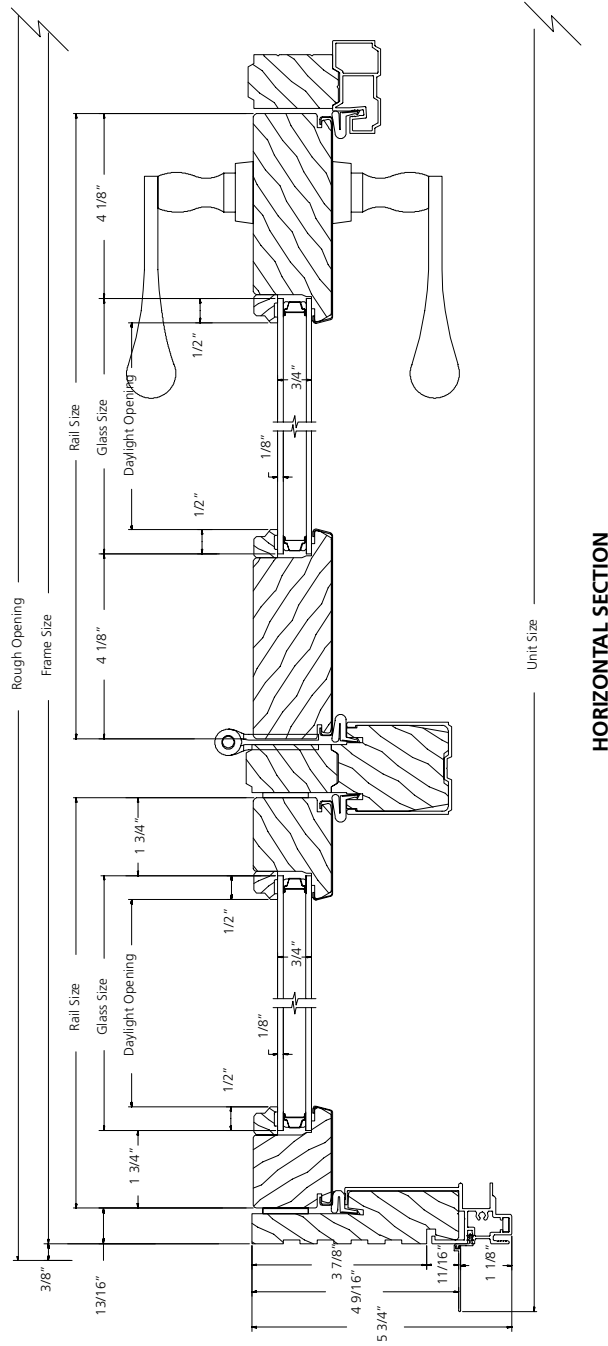

**HORIZONTAL SECTION**

SCALE: 3" = 1'

**STATIONARY UNIT WITH SIDELIGHT**

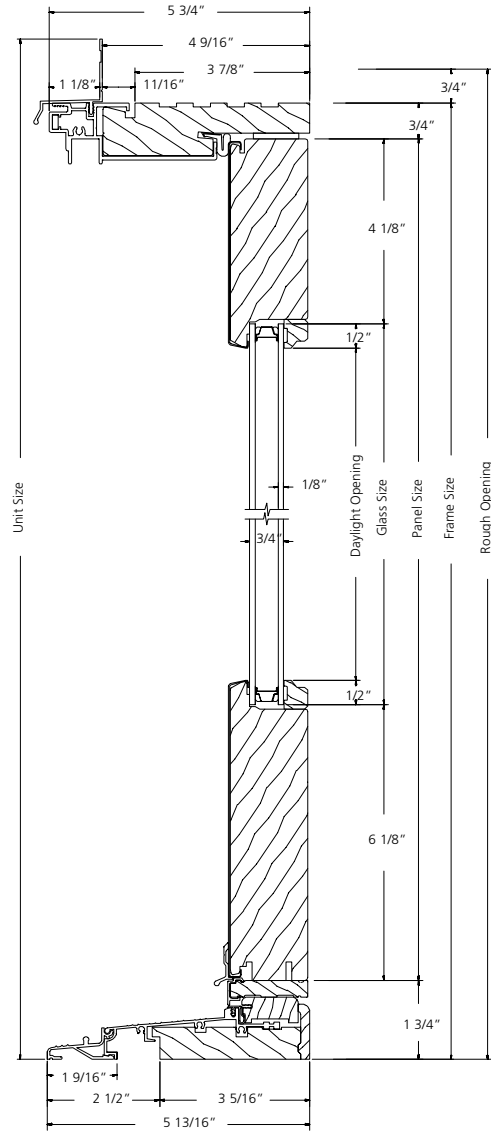

**VERTICAL SECTION**

SCALE: 3" = 1'

**STATIONARY UNIT WITH SIDELIGHT**

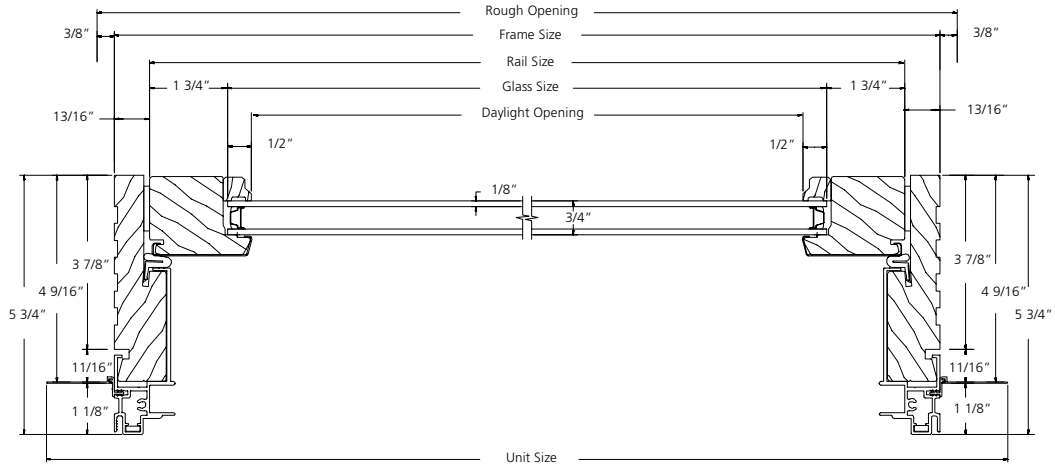

**HORIZONTAL SECTION**

SCALE: 3" = 1'



**1 PANEL OPERATING UNIT WITH SCREEN**  
**4-9/16" JAMB**

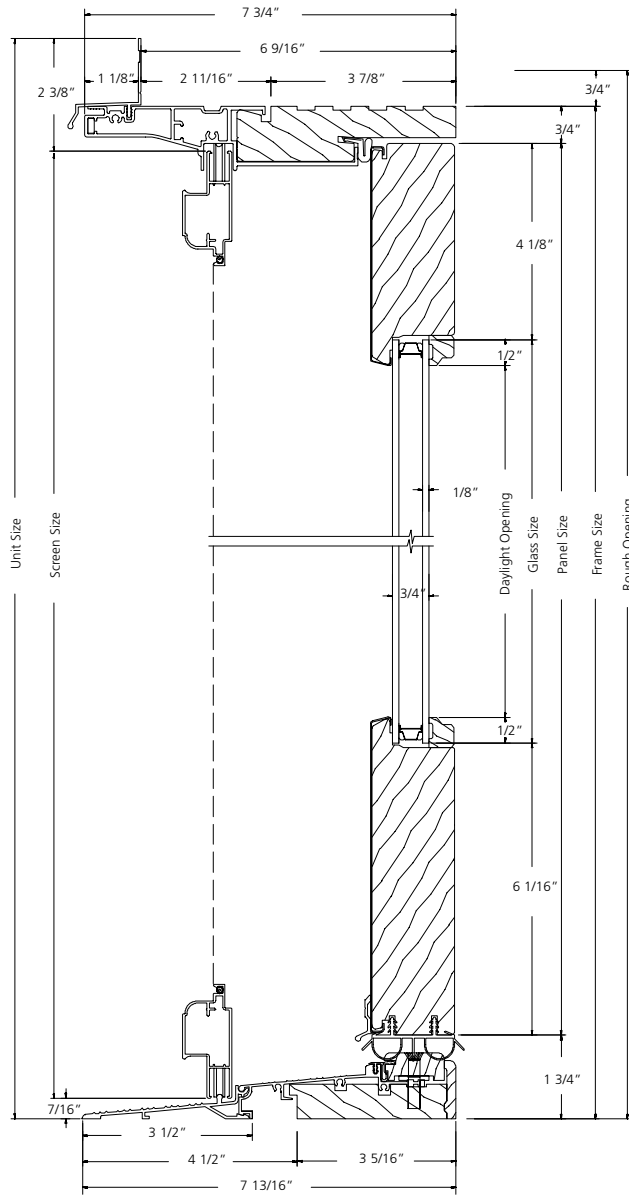

**VERTICAL SECTION**

SCALE: 3" = 1'

**1-PANEL OPERATING UNIT WITH SCREEN**  
**6-9/16" JAMB**

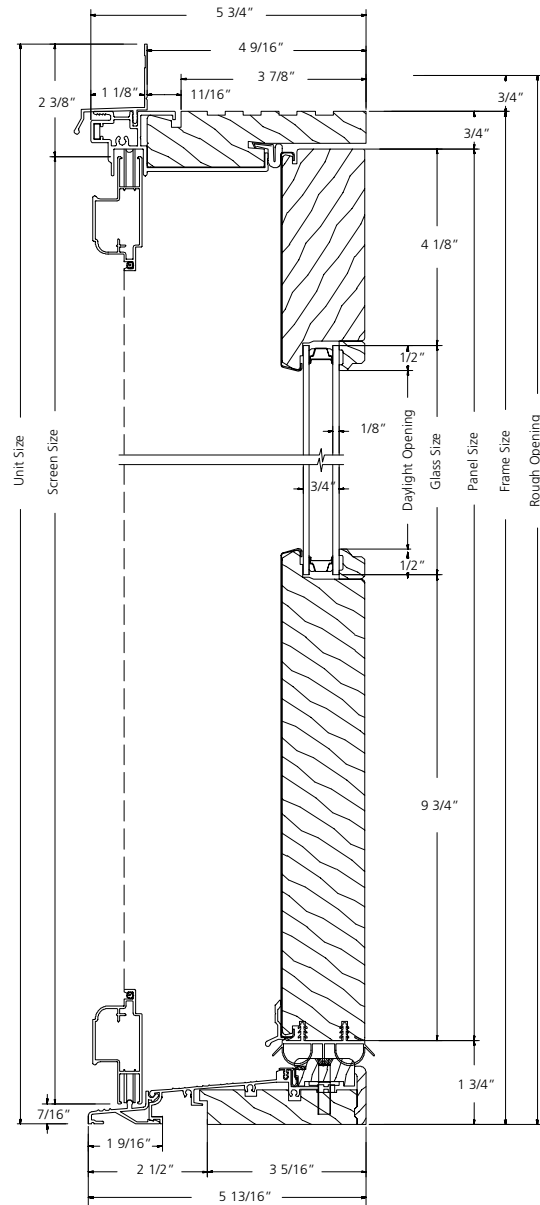

**VERTICAL SECTION**

SCALE: 3" = 1'

**SINGLE SASH TRANSOM  
WITH 4-9/16" JAMB**

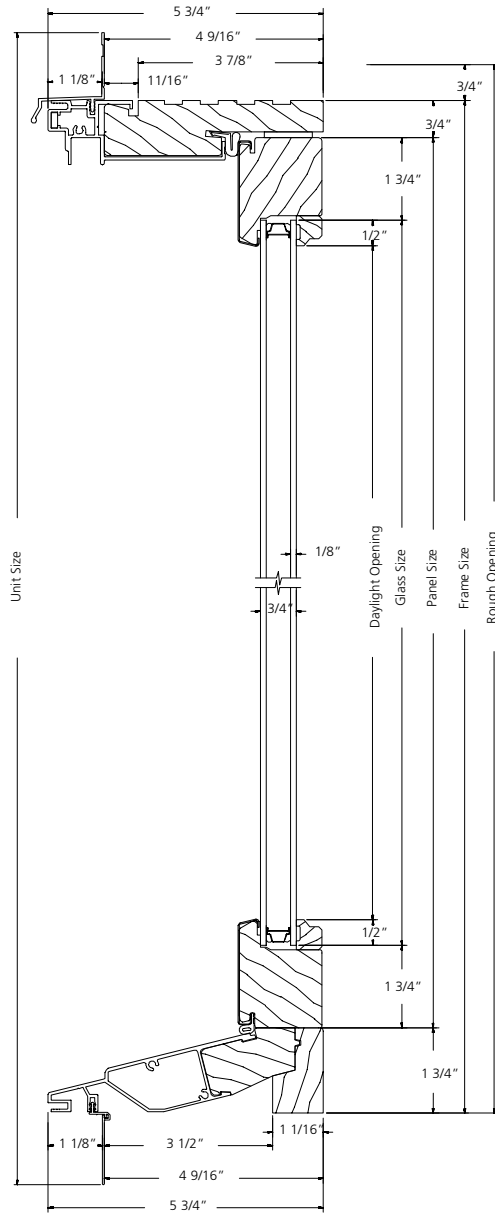

**VERTICAL SECTION**

SCALE: 3" = 1'

**SINGLE SASH TRANSOM  
WITH 6-916" JAMB**

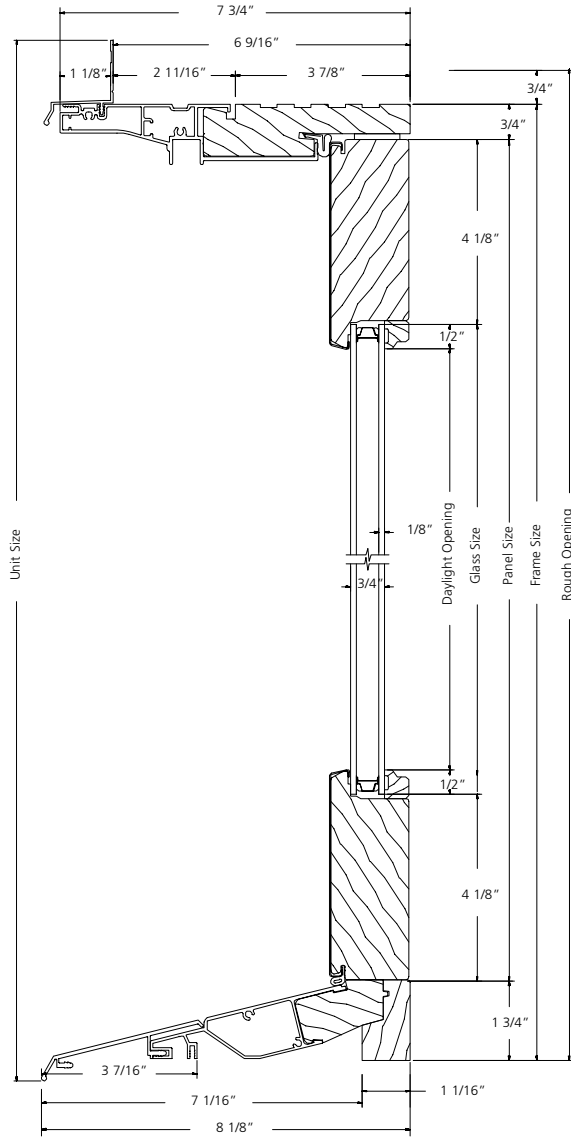

**VERTICAL SECTION**

SCALE: 3" = 1'

**SINGLE SASH TRANSOM**

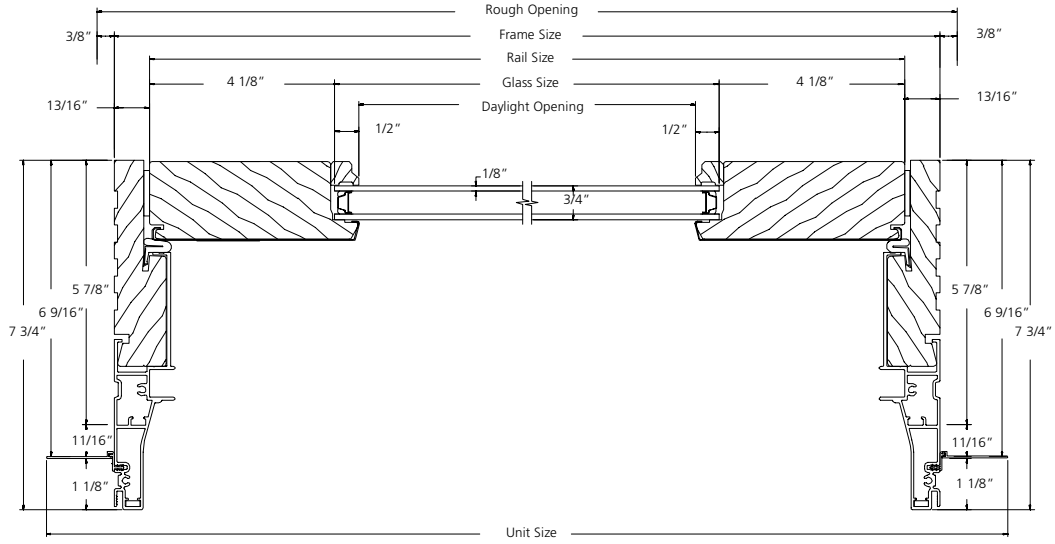

**HORIZONTAL SECTION**

SCALE: 3" = 1'

**MULTI-SASH TRANSOM**

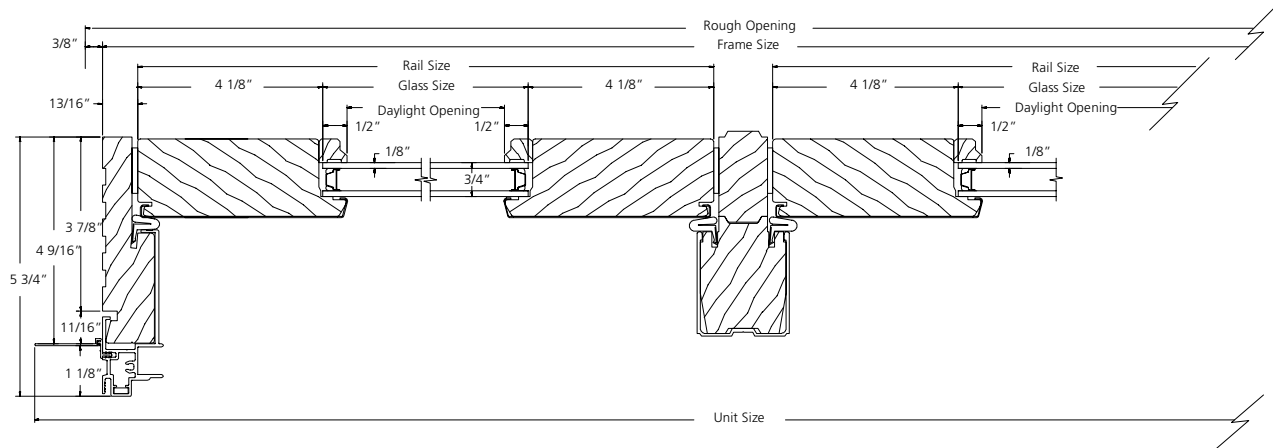

**HORIZONTAL SECTION**

SCALE: 3" = 1'